



# Stormwater Runoff, Lost Resource or Community Asset?

*A Guide to Preventing, Capturing and Recovering  
Stormwater Runoff*

*Delaware Riverkeeper Network  
Working since 1988 to protect and restore the Delaware  
River, its tributaries and habitats.*

*P.O. Box 326, Washington Crossing, PA 18977  
215-369-1188  
[www.delawareriverkeeper.org](http://www.delawareriverkeeper.org)*

*March, 2001*

*Funding for this manual has been provided by:*

*Helen Bader Foundation, Inc.  
Beneficia Foundation  
Geraldine R. Dodge Foundation  
The Fund for New Jersey  
The Philadelphia Foundation  
The Grundy Foundation*

*Technical review has been provided by:*

*Tom Cahill and Wesley Horner of  
Cahill Associates, West Chester, PA*

*Peer review has been provided by:*

*Dave Cannan, Commissioner, Radnor Township  
Bill Hilton, Brock Creek Watershed Association  
Rich Myers, Neshaminy Creek Watershed Association  
Larry Shaeffer, Pine Run Watershed Initiative  
Dr. G.D.V. van Rossum, Delaware Riverkeeper Network*

*Authored by Maya K. van Rossum, Delaware Riverkeeper and  
Tracy Carluccio, Special Projects, Delaware Riverkeeper Network  
Edits and photo layout by Mary Ellen Noble, Associate Director,  
Delaware Riverkeeper Network*

*Additional copies can be ordered by contacting:*

*Delaware Riverkeeper Network, P.O. Box 326,  
Washington Crossing, PA 18977  
Phone: 215-369-1188      Fax: 215-369-1181  
email: [drkn@delawareriverkeeper.org](mailto:drkn@delawareriverkeeper.org)*

*Riverkeeper is on the web at: [delawareriverkeeper.org](http://delawareriverkeeper.org)*

*Printed on recycled paper*

*Lost stormwater runoff . . .  
floods communities,*



*erodes the land,*



*chokes and smothers streams,*



*and pollutes lakes.*



## ***What is a Riverkeeper?***

A Riverkeeper is a full-time, privately funded, non-governmental ombudsperson whose special responsibility is to be the public advocate for a water body. A Keeper's clients are the river resource and the citizens who fight to protect it.

The Delaware Riverkeeper's job is to advocate for the Delaware River and all of the tributaries and habitats of the watershed. Supported by a committed staff and volunteers, Delaware Riverkeeper Maya van Rossum monitors compliance with environmental laws, responds to citizen complaints and need for support, identifies problems which affect the Delaware and responds accordingly. Serving as a living witness to the condition of the ecosystem, the Riverkeeper is an advocate for the public's right to protect and defend the environment.

## ***About the Delaware Riverkeeper Network***

The Delaware Riverkeeper Network (DRN) is a nonprofit membership organization and an affiliate of the American Littoral Society. Since 1988, the Delaware Riverkeeper Network has worked throughout the Delaware's 13,539 square mile watershed to strengthen citizen protection of the Delaware River, its tributaries, and habitats. Activities include taking stances on regional and local issues that threaten water quality and waterway ecosystems; organizing and supporting communities working to protect local streams; stream restoration projects; volunteer monitoring; pollution hotlines; an enforcement program; and student intern opportunities.

By joining the Delaware Riverkeeper Network you can help protect the natural resources of the Delaware River watershed, strengthening the voice that protects our environment, our quality of life, and our future.

-----<-----  
Yes, I'd like to become a member of the Delaware Riverkeeper Network.

\_\_\_ Guardian of the River: \$10,000 or more

\_\_\_ Protector of the River: \$5,000 - \$9,999

\_\_\_ Friend of the River: \$2,500 - \$4,999

\_\_\_ Otter Society: \$1,000 - \$2,499

\_\_\_ Sturgeon Guild: \$500 - \$999

\_\_\_ Shad Circle: \$100 - \$499

\_\_\_ Blue Crab Band: \$50 - \$99

\_\_\_ Striped Bass Bunch: \$35

\_\_\_ Other \$ \_\_\_\_\_

Enclosed is my tax deductible contribution of \$ \_\_\_\_\_

I would like to make my contribution of \$ \_\_\_\_\_ in honor of \_\_\_\_\_

I would like to give a gift membership of \$ \_\_\_\_\_ to \_\_\_\_\_

Please charge my Visa/MC Number: \_\_\_\_\_ Exp. Date \_\_\_\_ / \_\_\_\_

Signature of cardholder: \_\_\_\_\_

**Mail to: Delaware Riverkeeper Network, P.O. Box 326,  
Washington Crossing, PA 18977**

# Table of Contents

## **Stormwater Runoff, Lost Resource or Community Asset?**

*A Guide to Preventing, Capturing and Recovering Stormwater Runoff*

<b>Dedication</b>	<i>i</i>
<b>Preface by Tom Cahill, President, Cahill Associates</b>	<i>ii</i>
<b>Introduction</b>	1
<b>Chapter 1: Stormwater Runoff -- the Lost Resource</b>	3
A. <u>The Natural Hydrologic Cycle</u>	3
B. <u>Human Interference with the Hydrologic Cycle</u>	4
1. What we do today	5
2. The Detention Basin Fallacy	6
a. <i>VOLUME: There's too much and at the wrong time</i>	7
b. <i>Water Quantity/Hydrology Costs</i>	8
c. <i>Frequent Flooding Continues</i>	9
d. <i>Groundwater Aquifer Robbed</i>	10
e. <i>Wetlands Destroyed</i>	11
f. <i>Water Polluted</i>	12
g. <i>Water Quality Costs</i>	13
3. Where Do We Go From Here?	15
<b>Chapter 2: Stormwater Runoff -- the Community Asset</b>	17
<i>Preventing, Capturing and Recovering the Lost Resource</i>	
A. <u>Infiltration -- A New Dominant Paradigm Emerges</u>	19
1. Infiltration Improves Water Quality	20
a. <i>The Renovating Capabilities of Soil</i>	20
b. <i>Filtering out the First Flush of Pollution</i>	20

2. Infiltration Reduces Flooding by Decreasing Both Stormwater Runoff Volume and Peak Flows	21
a. ... by putting rainfall back into the ground	21
b. ... by restoring a natural path	22
3. The Success of the Infiltration Approach Requires Informed Implementation	22
B. <u>Protecting and Restoring Natural Stormwater Patterns</u>	26
<b>Chapter 3. Transforming the Lost Resource into the Community Asset: Accomplishing Infiltration, Filtration and Recharge</b>	29
A. <u>Minimum Disturbance in New Developments -- the Best Management Practice</u>	29
1. Implementing Conservation Design and Minimum Disturbance for Development	31
2. Conservation Design and Sensitive areas	34
a. <i>Conserving Headwaters by Design</i>	35
b. <i>Conserving Streams by Design</i>	36
c. <i>Conserving Wetlands by Design</i>	36
3. Reducing Overall Impacts --and Costs -- by Design	37
4. Conservation Design and Erosion Prevention	39
a. <i>Conserving Soil During Construction</i>	39
b. <i>Minimizing Site Disturbance: Preserving Nature's Design</i>	40
5. Fact Sheets	41
✓Protecting and Restoring Native Plant Communities and Forests	43
✓Preserving and Restoring Natural Soils	49
✓Riparian Buffers	51
✓Reducing Impervious Surfaces	59
✓Encouraging Open Space (Cluster) Designs	65
B. <u>Other Stormwater Best Management Practices -- Infiltrating Stormwater Once the Damage is Done</u>	69
1. Fact Sheets	71
✓Recharge Gardens/Rain Gardens	73
✓Vegetated Filter Strips and Buffers	75
✓Bioretention	79

✓ Grassed Drainage Swales	83
✓ Infiltration Trenches	89
✓ Porous Paving	93
✓ Constructed Wetlands	101
✓ Wet Ponds	105
✓ Infiltration Basins	109
✓ Vegetated Rooftops and Roof Ponding Areas	113
✓ Rain Barrels and Rain Gutter Retrofits	115
✓ Additional Ideas for Site Specific Solutions	117
C. <u>Infiltration and Best Management Practices Are Also a Solution for Existing Development</u>	121
1. Changing the Way Things Are	121
a. <i>Identifying Opportunities for Reducing Runoff and Increasing Infiltration</i>	121
b. <i>The "Ultra-Urban" Option: The Last Choice</i>	124
c. <i>Funding Options</i>	125
2. Moving People Out of Harm's Way and Protecting the Floodplain	126
a. <i>Why Restore the Floodplain?</i>	126
b. <i>How the Floodplain Is Regulated</i>	127
c. <i>New Policies Are Discouraging Floodplain Construction</i>	128
(i) Repetitive Loss Properties	129
(ii) Reclaiming the Floodplain	129
3. Initiatives To Restore the Floodplain	131
<b>Chapter 4: Working on a <u>Watershed</u> Basis</b>	135
A. <u>Achieving Multiple Community Objectives Through a Watershed-Based Approach to Stormwater Management</u>	136
B. <u>Achieving Regulatory Requirements Through a Watershed-based Approach to Stormwater Management</u>	137
1. TMDLs	137
2. NPDES II	138
C. <u>Implementing Watershed-based Planning</u>	139
D. <u>How to Encourage use of Stormwater Infiltration and Best Management Practices in Watershed Planning</u>	140



<b>Chapter 5: Municipal Regulations: "The Force is With You"</b>	143
<b>Endnotes</b>	147
<b>Appendix A: Native Plants: What Are They and Where Can I Find Them?</b>	
<b>Appendix B: Sample Municipal Ordinance</b>	
<b>Appendix C: Stormwater Credits: A Means of Supporting BMP Implementation</b>	
<b>Appendix D: Natural Resource Fact Sheets</b>	
✓ Floodplains and Their Environmental Functions	
✓ Wetlands, Natural Wonders in Need of Protection	
✓ Large Wood Debris in Our Streams: Enhancing Environmental Health, Not Local Flooding	
✓ "Green" Yards Protect Streams	
✓ Plant a Native Landscape	
✓ Land Cover and Hydrologic Implications	

## Dedication

As we enter the 21<sup>st</sup> Century, the natural world is disappearing before our eyes. We watch living streams with healthy ecosystems fade away into lifelessness.

This Handbook is dedicated to those who are determined to protect the irreplaceable natural wonders on which we, and all life on Earth, are so dependent. And it is dedicated to seeing that life thrive into the future.



## Preface

Thomas Cahill is the Principal Environmental Engineer and President of Cahill Associates of West Chester, PA. He has over 37 years of professional experience in water resources engineering, hydrology, hydraulics, natural resource planning, and environmental engineering. Mr. Cahill is nationally known as an expert and leader in the field of stormwater management and sustainable design. He has pioneered the use of innovative stormwater management techniques such as porous pavement and infiltration technologies. He has consulted on projects for the US Environmental Protection Agency, NJ Department of Environmental Protection, PA Department of Environmental Protection and Department of Conservation and Natural Resources, as well as numerous other public, private and municipal entities. His many published works include government guidance manuals as well as sustainable watershed management studies featuring hydrologic and chemical modeling based on a Geographic Information System.

For centuries, we have attempted to protect our communities from the ravages of flooding by building dikes along riverbanks, damming rivers and building our structures and transportation systems above the historic flood level. Until the past century, these waterways served as our primary transportation corridors, and we clustered our towns and cities as close as possible for both commerce and habitat. The American experience of clearing the forest and cultivating the new land to create “amber waves of grain ... from sea to shining sea” altered the upland and interiors of most river valleys during our first two centuries, changing the natural systems of land and water. In the twentieth century, the automobile totally altered our urban landscape, as we followed ribbons of highway into the open countryside to build new communities, loosely bound to the older cities by the transportation elements. Surrounding every city, a vast tidal wave of pavement covered the fields and remnant woodland, as we attempted to flee the density of the urban center but retain the convenience of the village marketplace.

As our manmade environment changed, we found that stormwater was much more than a river valley flood problem and impacted our communities in other ways. The erosion of soil from bare land, as created on cultivated fields, was long a concern to the farming community. The dust bowl of the 1930’s demonstrated clearly what harm could result if the land was not managed properly in flood and drought, and the government spent thirty years developing better ways to protect the soil and reduce the loss of sediment with stormwater runoff. By the late 1960’s, as our suburban land development patterns produced much the same result of polluted runoff, we applied the same basic solution. We build a pond down the hill to temporarily capture the stormwater, retain the sediment and reduce the flooding impacts on the local stream channel.

The design and construction of detention basins became the national standard for stormwater “management”, and are an integral part of every new residential community, office park and shopping center built over the past twenty-five years. That experience has taught an important lesson – we must do better, developing solutions to both the quantity and quality impacts of stormwater. Our stormwater systems must reduce the volume of runoff to pre-disturbance volumes, recharge the essential groundwater aquifers, and reduce or prevent non-point source pollution. These three ingredients will define stormwater design for the next century.



This Guide gathers together in one document, written for our neighbors rather than a panel of experts, the sum of our current experience. It is not a “Best Management Practices” Manual, since we have not yet discovered or developed the best solutions. It serves to introduce the public to alternative technologies, methods and materials, drawing from a body of references that can be investigated in greater depth by any interested reader. The Guide begins by explaining why we must apply new solutions to this age-old problem, as our changing use of the land increases the impacts on the natural water balance. Most importantly, it is intended to guide our thinking as we build and rebuild our communities, recognizing that the water cycle is the single most important element of our habitats.

*By Tom Cahill, President of Cahill Associates*





# Stormwater Runoff, Lost Resource or Community Asset?

## *A Guide to Preventing, Capturing and Recovering Stormwater Runoff*

### Introduction

The Delaware River watershed is changing. Communities are growing, indelibly changing the landscape, our quality of life, and the health of our waterways. Forests, farms and meadows are being transformed into houses, shopping centers, roadways and parking lots. Rainwater was once absorbed into vegetated soils, recharging aquifers and maintaining stream base flow and waterway health. Now it is collected on impervious surfaces, in detention basins and extensive systems of pipes that dump it directly into streams, wetlands, lakes and rivers. As a result, this rainfall is lost as a resource for the long-term health of natural water systems. Our man-made approach to stormwater management is causing floodwaters to rise and streambanks to erode, streambeds and drinking wells to run dry, critical aquatic and terrestrial habitats to be lost, and water quality to quickly decline.

#### **Communities are looking for solutions!**

It's becoming painfully obvious that the solutions of the past don't work. Since the early 1970s, the Army Corps of Engineers has spent over \$25 billion on flood control projects.<sup>1</sup> And yet, today, annual flood losses average more than \$4 billion a year, more than triple what they were in 1951.<sup>2</sup> As recently as 1999, municipalities in the Delaware River watershed were declared federal disaster zones as a result of flooding. At the same time, it is well recognized that non-point source pollution, pollution washed from the land, is presently the largest contributor to declining water quality nationwide -- as it is in the Delaware River watershed.



declared federal disaster zones as a result of flooding. At the same time, it is well recognized that non-point source pollution, pollution washed from the land, is presently the largest contributor to declining water quality nationwide -- as it is in the Delaware River watershed.

As communities cope with the problems of increased stormwater runoff, they are forced to also give up human opportunities that healthy watersheds provide. Clean streams and healthy watersheds enhance the quality of life of those who live, work and enjoy the resources this environment provides. Tree shade, the beauty of natural vegetation, the birds and other wildlife that are part of intact ecosystems contribute to our lives. Highly engineered solutions -- dams, basins, concrete conduits -- don't provide a child with a creek to fish or play in or give us a quiet tree to sit under. People notice these differences.

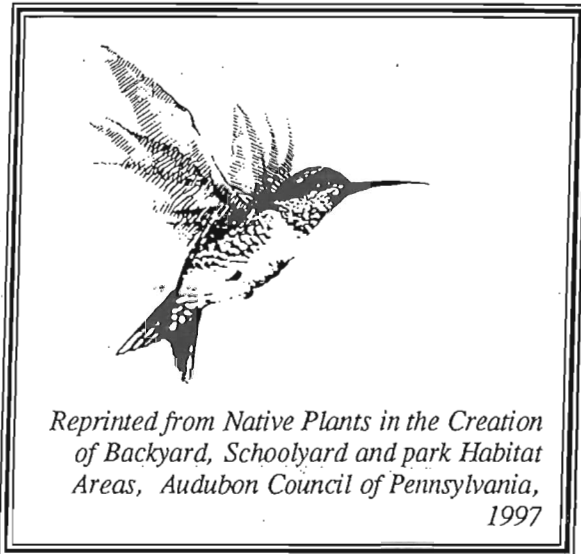

In the 1970s, in response to flood events, regulations requiring detention basins and other structures that would control the peak rate of stormwater run-off were put in place in new developments. While at the time a step ahead, it has proven to fall far short of what is necessary to really control runoff and protect natural resources. The peak rate approach to managing stormwater runoff (usually implemented using a detention basin system) allows the total volume of stormwater runoff to increase; can increase the duration of flood flows and heighten the peak of downstream flooding in the watershed; and results in increased erosion, siltation, water quality degradation and adverse ecological impacts downstream.<sup>3</sup>

**It's clear that we need a fresh approach. The balance provided by the natural hydrologic cycle needs to be restored.<sup>4</sup> Our concept of stormwater management must expand to include base flows as well as peak flows, water quality as well as water quantity, and stream health as well as human health.**

The goal of this handbook is to explore the solutions that work and to provide citizens and decision makers information and tools they need to secure successful stormwater management in their own communities by using both preventive and mitigative measures.

# Chapter 1: Stormwater Runoff -- the Lost Resource

## A. The Natural Hydrologic Cycle

To nature, stormwater is a resource.

In the natural hydrologic cycle a proportionately small part of a rainfall runs off the land. Most of the precipitation is captured and gently released into the natural environment over time, thereby sustaining environmental health and equilibrium. As rain falls from the sky it is intercepted by leaves and branches which dampen the energy of the falling water before it hits the ground. A portion of the water evaporates from the leaves and the ground. In larger storms and in certain conditions a portion may run off the land and eventually follow a path to the local stream. But the greatest portion of the rainfall is absorbed into the land where it is stored, used by vegetation, and infiltrates to the aquifer below. An aquifer is an underground water reservoir that stores water and releases it slowly, over time, to a waterway as base flow or provides drinking water through wells. Water that returns to the sky as evaporation from vegetation, the land, and waterways returns again later as rainfall. This never-ending circular system is how life is supported in the watershed.

**Definition: Base Flow** -- When it hasn't rained in two or three days the flow you see in the stream is coming from the groundwater aquifer (also called the water table) and is called base flow.

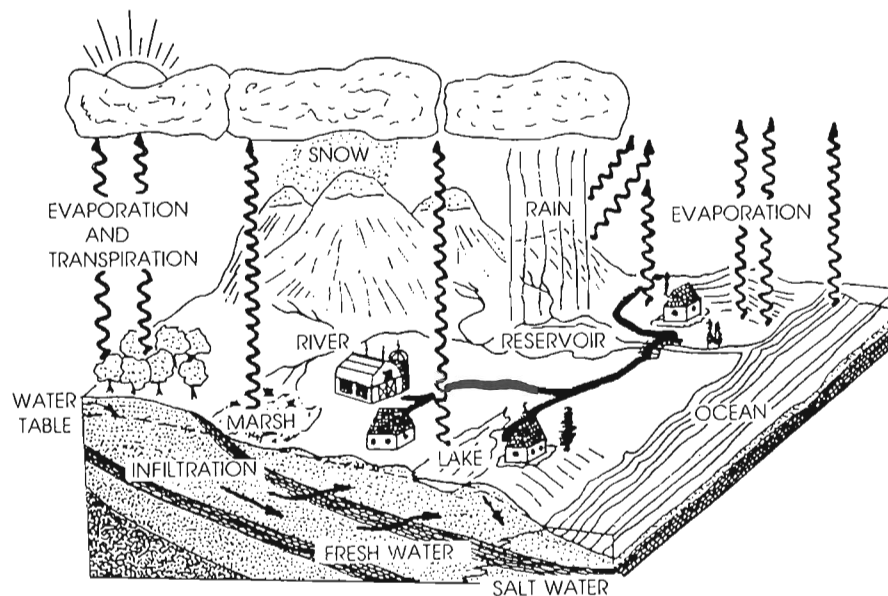

### The Hydrologic Cycle

*Reprinted from Reducing the Impacts of Stormwater Runoff  
from New Development, NYDEC, 1992*



On average, 45 inches of rain falls every year in the Delaware Valley. In the Piedmont and Upland portions of the watershed, before the land is developed, only about 8 inches of this 45 inches run off the land -- the other 37 inches are returned to the sky as evapotranspiration (22 inches) or soaks into the ground (about 15 inches). After the land is developed these numbers are dramatically altered and the bulk of the rainfall is lost as runoff -- 8 inches of runoff increases to 40 inches or more. In the estuary portion of the watershed, when the land is paved over, 2.5 inches of runoff increases to 40 inches annually. <sup>5</sup>

**Definition:** Evapotranspiration -- Water lost from the land by evaporation and plant uptake.

Dictionary of Ecology,  
by Herbert C. Hanson

## B. Human Interference with the Hydrologic Cycle

When the land is paved over, the hydrologic cycle is altered.

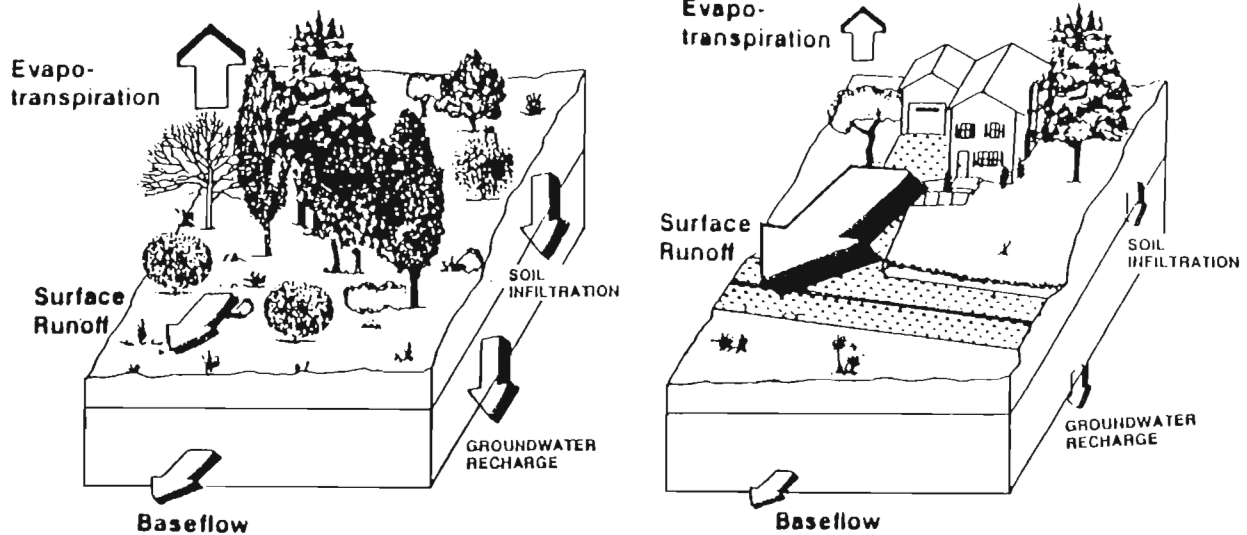

### The Impact of Development on the Hydrologic Cycle

*Reprinted from "Stormwater Management Systems, Porous Pavement System with Underground Recharge Beds, Engineering Design Report", Cahill Associates, Spring, 1993*

**Definition:** Impervious surface -- "those surfaces in the landscape that cannot infiltrate rainfall" such as building rooftops, pavement, sidewalks, driveways, and compacted earth or turf.

*2000 Maryland Stormwater Design Manual, MDE, Volume I, glossary, draft, 1999.*

Roads, rooftops, compacted soils and other impervious surfaces create a barrier between the rainfall and the natural land forcing the water to run off. The loss of vegetation that comes with development further disrupts the ability of the soil to function naturally as a sponge. The increased runoff alters the hydrologic cycle -- water which once fed aquifers, streams and wetlands, sustaining natural resources during dry periods, is now lost in a mad rush during and after storm events. While running over the land surface, the water washes





*Conventional development . . .  
big,*



*and small,*



*comes with conventional . . .  
detention basins, and*



*stream channelization.*



toxics, litter, nutrients and sediment into natural water systems, degrading water quality. And heated water washed from hot paved surfaces increases stream temperature. The water table becomes depleted, habitats altered, stream flow and aquatic life are all changed as a result. Human communities feel this change in the form of flood, drought, declining water quality and changes in their natural environment.

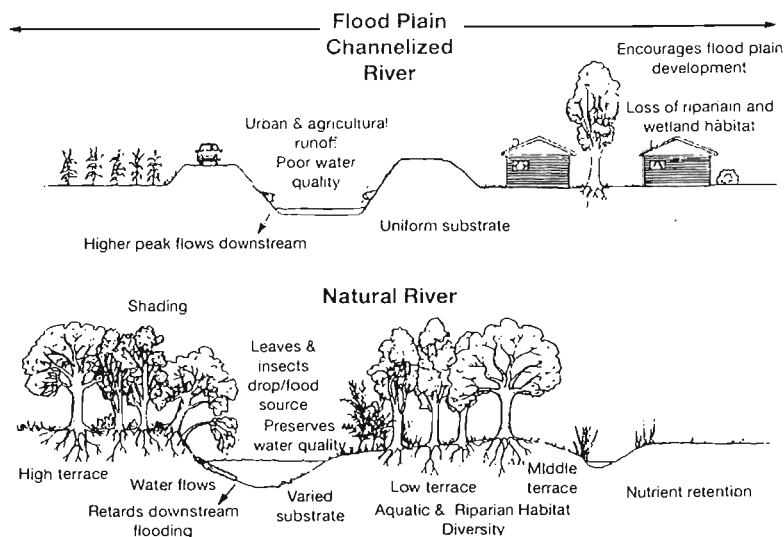

**A natural versus a channelized river.**

*Reprinted from "California's Rivers; A Public Trust Report,"  
Prepared for the California State Lands Commission, 1993.*

**1. What we do today**

Modern day stormwater management is generally comprised of stormwater conveyance systems designed to gather rainwater from rooftops, roadways, parking lots, lawns and other impervious surfaces and convey the water directly to the local stream. Development prior to the 1970s had little-to-no stormwater management. Systems were built only to carry and quickly convey stormwater runoff to the stream. In the '70's, efforts began to address runoff-induced flooding. These more recent stormwater management systems, including detention basins, focus on addressing the peak rate of runoff -- holding the runoff for a few hours before it is sent through a deliberately sized pipe directly to the local waterway. The theory is that by controlling the peak flow from a site, downstream flooding peaks can be reduced.

**Definition:**  
Peak Rate of Runoff -- generally measured in cubic feet per second, it is the maximum instantaneous rate at which runoff is discharged from a site as the result of a precipitation event.

However, the standard peak rate methods for controlling stormwater runoff fail to recognize that changes to one part of the hydrologic cycle will create comparable impacts elsewhere in the cycle. If there is a decrease in infiltration then there will be a loss of storage somewhere else in the cycle; there will be a decrease in the amount of the water that infiltrates to the



The Science of Ecology:

*You can never merely do one thing.*

Garret Harden

aquifer; and there will be an equal increase in the volume of runoff. This changed condition alters the natural flow regime of a stream, impacting the established pattern of natural hydrologic variation, altering habitat dynamics and disturbing the species which are adapted to the stream's hydrology.<sup>6</sup> The duration, and eventually the height, of flooding increases.

The reduced infiltration and greater volume of runoff leads to a greater quantity of water entering waterways. This stormwater runoff enters waterways either directly off the land or through man-made stormwater conveyance systems. The combination of increased volume and velocity far exceeds the natural condition and changes the hydrology of the stream. The resulting changes cause greater annual water level fluctuation. The increase in volume causes the stream to jump out of its banks more often, increasing the frequency of flooding and severity of existing flooding, while at the same time causing new flooding where once there was none.

Changes to stream flow, alterations to the physical structure of the stream, and water quality degradation reduce stream biodiversity and hurt aquatic life.<sup>7</sup> As the heavy, fast-moving flow moves downstream, it undercuts stream stability, scours streambanks and the stream bottom. As a result, the stream is channelized, riparian vegetation is undercut, adjacent floodplain forests can be harmed or killed, and stream bottom habitats are destroyed. The channelization process causes sedimentation and turbidity, which blocks light from submerged aquatic vegetation and can inhibit proper gill function of fish.<sup>8</sup>

## **2. The Detention Basin Fallacy**

The goal of detention basins is to attenuate the peak rate of runoff. Basins are designed to collect and hold stormwater for a period of time and then release it directly into the local stream through a pipe sized to pass flows at what are calculated to be pre-development peak rates. The intention is to ensure that the post-development peak rate is no greater than the pre-development peak rate of runoff from that parcel of land.<sup>9</sup> But by using a detention basin approach, a greater volume of water is discharged to the stream system over a longer period of time.

Detention basins do not deal with the increased volume of water running off the land. The net result can cause flood flows to last longer and contribute to increased peak flows farther down the watershed<sup>10</sup> -- i.e. increased flooding over a longer period of time.<sup>11</sup>

Another problem with the detention basin approach is that the runoff's time of concentration is reduced from the developed site. The time of concentration is the period of time it takes for one drop of water to travel from one end of a site to a stream. Where impervious surface has increased, infiltration and filtration have decreased. The result is that runoff reaches the location of the detention basin faster and dirtier than it would have naturally. The detention basin, likewise, bypasses filtration and infiltration opportunities by carrying the water in an

enclosed pipe directly to the stream. This means that a detention basin's greater volume enters the creek prematurely and without the filtering effect of the naturally slower movement over vegetated lands. Detention basin design doesn't mitigate the premature discharge since it only controls the peak rate of flow and provides no time for effective settling. This, too, contributes to harmful stream impacts.

Let's look closely at the problems that result from the peak rate/detention basin approach.

**a. VOLUME: There's too much and at the wrong time**

A critical factor that is forgotten in the detention basin (peak rate) approach is the increased volume of runoff. Detention basins (and other strictly "peak rate" strategies) do nothing to decrease the greater quantity of runoff from a developed site. Despite the fact that the pre-development peak rate of runoff is maintained (or even reduced), because there is an increasing VOLUME of runoff, the detention basin is directly contributing MORE water to our streams over a LONGER period of time and is extending the length of that peak discharge.

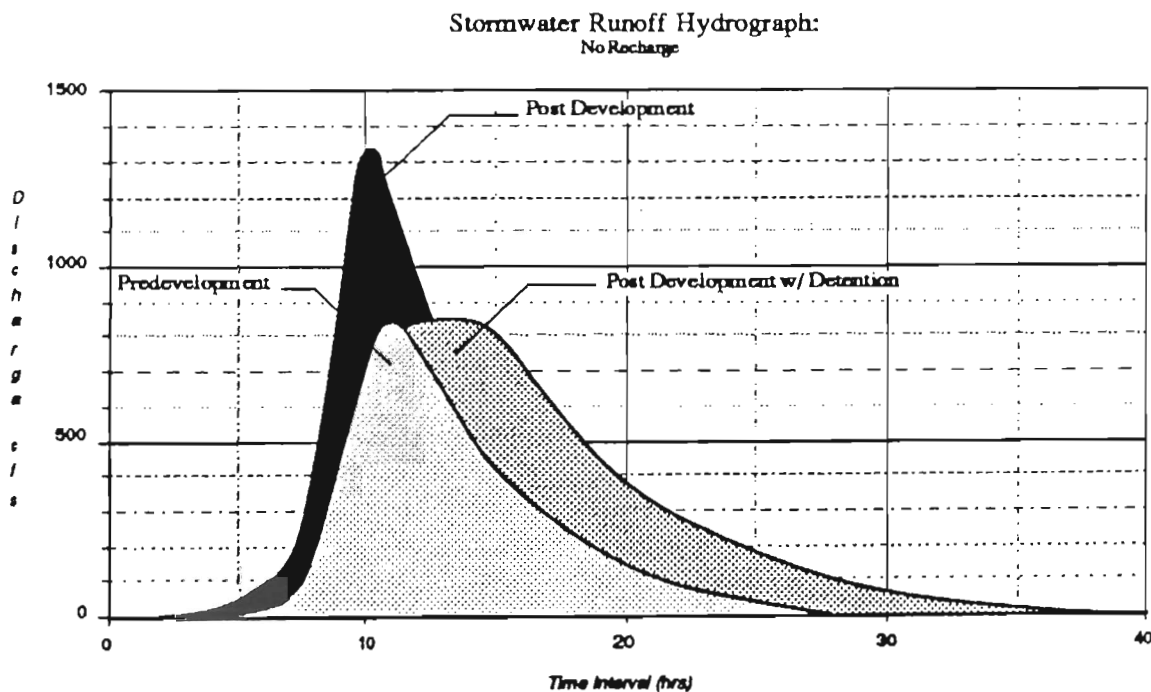

**Hydraulic design of a typical detention basin.**

*The graph shows that while the peak rate of stormwater runoff remains the same pre- and post-development with the use of a detention basin, the quantity of runoff increases dramatically.*

*Reprinted from "Stormwater Management Systems, Porous Pavement System with Underground Recharge Beds, Engineering Design Report", Cahill Associates, Spring, 1993*

The cumulative impacts of many detention basins operating in a watershed (as is the case in many recently developed or presently developing suburban communities) further compounds



flooding problems. The releases from the many basins extend the time over which peak flows from tributaries and detention systems merge causing an increase in instream volume over a longer period of time.<sup>12</sup> The result is that downstream flooding is exacerbated -- flood flow is increased and extended. For example, while the predevelopment peak in the watershed may have lasted one hour, the post development peak may last 11 or 12 hours.<sup>13</sup>

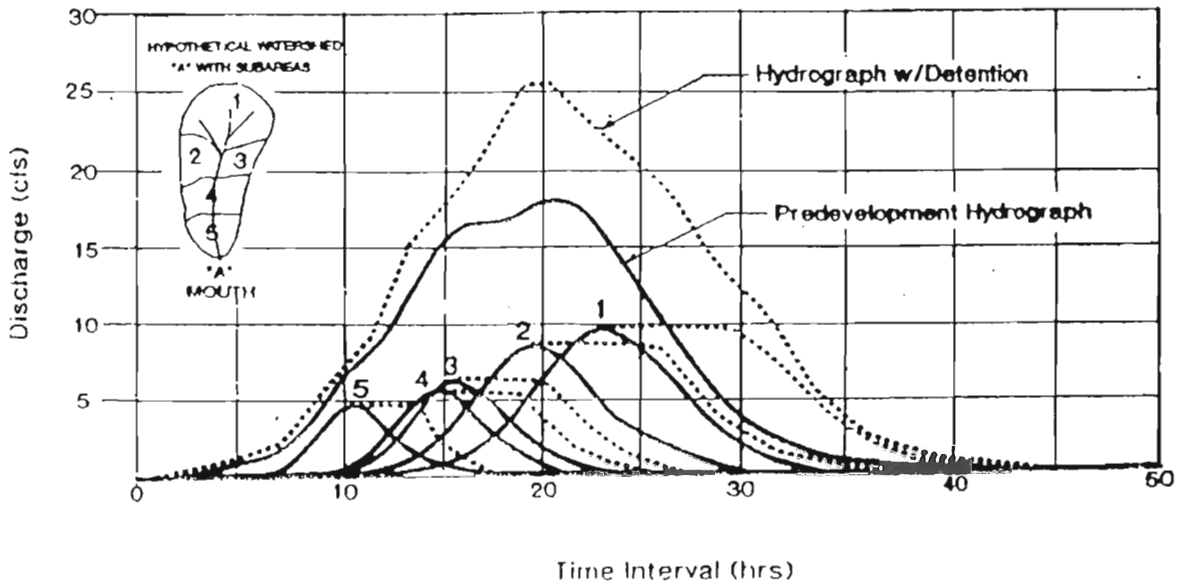

**Cumulative impacts in a watershed from a detention basin approach.**

*A peak rate control approach, when used watershed wide, can increase flooding downstream.*

*Reprinted from DNREC and Brandywine Conservancy, "Conservation Design for Stormwater Management; A Design Approach to Reduce Stormwater Impacts from Land Development and Achieve Multiple Objectives Related to Land Use", September, 1997, p. 1-15*

Today's development practices result in the conversion of pervious, porous surfaces, to impervious surfaces. The fact is that the more a watershed is paved, devegetated and its soils compacted, the more efficient it becomes in the delivery of a greater volume of runoff and nonpoint source pollution to our waterways.

**b. Water Quantity/Hydrology Costs**

One of the most dramatic and devastating impacts of increased stormwater runoff is flooding. As impervious cover diminishes the ability of the land to soak up and percolate rainfall, stormwater volume increases and causes increased flooding. In the Midwestern United States, recorded data shows that current discharges to streams may be 200 to 400 times greater than historic levels.<sup>14</sup> One study estimated that because of the increase in

With the detention basin approach, the duration of flood flows increases as does the volume and peak rate of runoff for the watershed. The increase in frequency, volume and magnitude of peak flows increases streambank erosion, undercuts tree root systems and destabilizes streambanks. The sediment entering the system both from bank erosion and from what is washed from the land smothers stream bottom habitats.

*DNREC and Brandywine Conservancy,  
"Conservation Design for Stormwater Management; A Design Approach to Reduce Stormwater Impacts from Land Development and Achieve Multiple Objectives Related to Land Use",  
September, 1997.*



impervious cover in a watershed, a flood event that should be expected once in 100 years could occur once every 5 years when the impervious cover reaches 65%.<sup>15</sup>

Over 90% of the native vegetation in the United States has been destroyed or degraded, causing the historic diffuse overland flows to change to concentrated flows with increased runoff rates, forming more defined streambeds that carry higher and faster flood flows.<sup>16</sup>

The cost of flooding can be measured in dollars, in human misery and in environmental destruction. In dollars, the United States pays a high price through our taxes to repair flood-damaged properties. Over the past 25 years, approximately \$140 billion in federal tax revenue has been spent preparing for and recovering from natural disasters, including floods, which account for most of the expenses.<sup>17</sup> In the same time period, the U.S. Army Corps of Engineers has spent more than \$25 billion on flood control projects.<sup>18</sup> Other agencies, such as the Natural Resources Conservation Service (formerly the Soil Conservation Service) have also spent billions on flood control measures, including dams and floodproofing. Despite these expenditures, flood damages have increased. Long-term average annual flood damages, in constant dollars, are more than double what they were in the early 1900's.<sup>19</sup> In the past 5 years, flood damages in the U.S. have exceeded \$40 billion, well above any past period.<sup>20</sup>

"As more and more land is cleared for development and paved over, there is less and less available to soak up excess water. ... The runoff has to go somewhere, and places that never flooded before are now at risk."

*James Lee Witt, Director of FEMA  
"No One Safe from Flooding, FEMA  
Says", FEMA News Desk,  
April 1997*

#### **Definitions:**

Two year storm -- the 24 hour storm event which exceeds bankfull capacity and occurs on average once every 2 years (or has a 50% chance of occurring in a given year).

Ten Year storm -- the 24 hour storm event which exceeds bankfull capacity and occurs on average once every 10 years (or has a 10% chance of occurring in a given year).

One hundred year storm -- an extreme flood event which occurs on average once every 100 years (or statistically has a 1 in 100, or 1%, chance of occurring in a given year).

*2000 Maryland Stormwater Design Manual, MDE, Volume I, glossary, draft, 1999*

#### **c. Frequent Flooding Continues**

The damages that accompany the more frequent, smaller storms, are growing. The 2-year storm in a natural watershed produces a flood that fills the stream to the top of its banks ("bankfull flood").<sup>21</sup> In developing or urban watersheds, because of the increased volume of runoff, a more frequent storm can cause a bankfull flood while 2 to 5-year storm flows exceed the carrying capacity of the stream and consequently jump the stream's banks and can cause extensive flood damages. As a result, now the 2 to 5-year storms cause a lot of flood damage and channel erosion, and contribute significant levels of nonpoint source pollution.<sup>22</sup>

Most detention basins are designed to control only the 10 to 100-year frequency storms.



Detention basins generally fail to impact the 2 to 5-year storm -- having pipes that pass those flows unchecked to the stream. While unchecked even by detention basins, these smaller storms cause many of the stormwater runoff problems that need to be addressed, particularly as development increases and damage caused by the smaller storms grows.

**d. Groundwater Aquifer Robbed**

One recent study demonstrated that a typical suburban-density development with the typical 23% impervious cover, would deprive groundwater aquifers of over 40 million gallons of recharge per square mile annually.<sup>23</sup> When considered on a watershed basis, conventional development results in dramatic groundwater losses.

Increasing stormwater runoff and associated loss of rainfall infiltration also means reduced stream base flow. Reduced stream base flow results in less dilution of pollutants and therefore a greater concentration of pollutants in our stream systems -- the stream's assimilative capacity is compromised. The loss of water also stresses aquatic communities and streamside habitats.<sup>24</sup> This loss of base flow is why streams in many areas are drying up when rainfall is not plentiful -- and this can eventually destroy the life in the stream.

Reduced base flow also causes higher water temperatures since natural groundwater discharge to the base flow of the stream is reliably cool.<sup>25</sup> Water temperature increases because the cool ground water that feeds base flow of a stream is replaced by surface runoff from asphalt and other warmed surfaces. This surface runoff may be 83 degrees F or higher in the summer.<sup>26</sup> Higher temperatures can change the fish community. Sensitive species, such as trout, prefer temperatures of 68 degrees F or less and begin dying when water temperatures reach 77 degrees F.<sup>27</sup> Increasing water temperature can also reduce fish abundance and diversity and invite more pollution-tolerant species.<sup>28</sup>

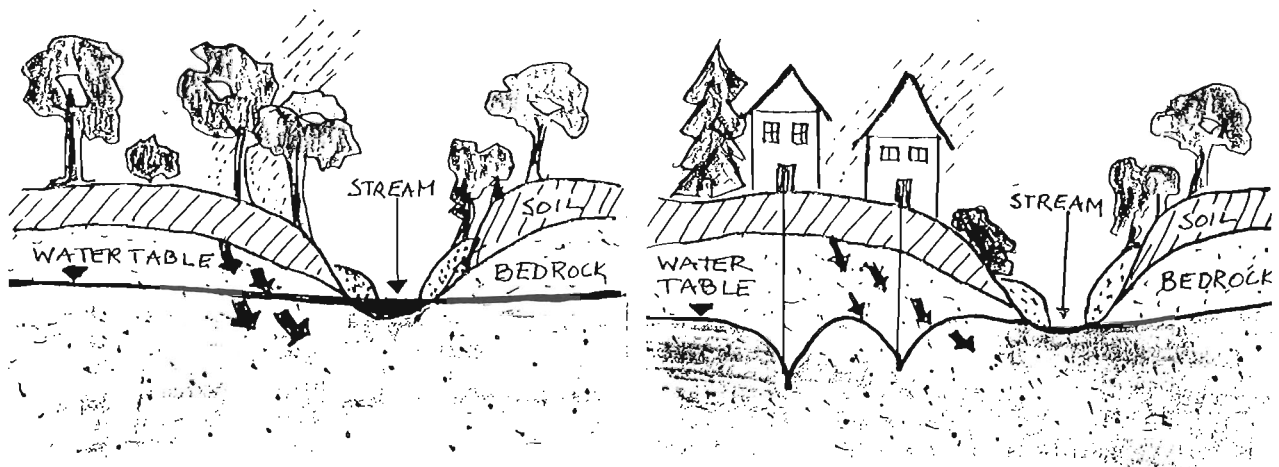

**Increasing stormwater runoff and associated loss of rainfall infiltration also means reduced stream base flow, declining drinking water aquifers, and loss of aquatic habitats.**

*Picture provided by M.E. Noble, Delaware Riverkeeper Network*





The loss of groundwater that results from the peak rate/detention basin approach also negatively impacts drinking water supplies because wells will run dry if the static underground water level drops below the well intake and there will be less water stored in the underground aquifer upon which the wells can draw. As recharge decreases, the aquifer is eventually drawn down and, when stressed, may never recover to pre-stressed levels.

#### **e. Wetlands Destroyed**

Wetlands provide a number of important benefits including storing and slowing the release of stormwater, improving water quality by filtering out pollutants, recharging groundwater, preventing erosion and providing productive and diverse ecosystems for both aquatic and terrestrial wildlife.<sup>29</sup>

Wetlands often function as a buffer or filter that protect waterways from pollution washed from the land. The dense vegetation found in wetlands filters out sediment, nutrients and other pollutants.<sup>30</sup> Wetlands can also filter pesticides and heavy metals and can reduce water-borne bacterial contamination through microbial action.<sup>31</sup>

The value of the water purification provided by wetlands has been estimated by one study to be \$6,600 per acre.<sup>32</sup> This value can be reduced or lost if the wetland's water quality function is impaired.

In spite of the tremendous value of wetlands to both our human and non-human communities, more than half of the wetlands in the lower 48 states have been lost to development, agriculture, mining, hydrology alterations and pollution.<sup>33</sup> On average, a half million acres of wetlands per year are being destroyed.<sup>34</sup>

According to the US Environmental Protection Agency (USEPA), nonpoint source pollution from runoff is destroying the function of wetlands across the nation, with siltation accounting for nearly half of the existing wetland acreage that is adversely impacted. The State of Delaware reported that all of the designated uses of wetlands in that state are compromised by nonpoint source pollution.<sup>35</sup> This is most likely typical of all Delaware River watershed states.

Loss of wetlands increases soil erosion, damages water quality and allows increased sedimentation and polluted runoff into streams.<sup>36</sup> Increased stormwater flows can upset the "dynamic equilibrium" that exists between wetlands and the surrounding watershed. Changes in volume or quality of runoff to wetlands can effect the biological community and ecological functions of a wetland. For instance, hydrologic conditions affect non-living factors such as salinity, soil oxygen availability, and nutrient availability. Water depth and immersion period (also known as "hydroperiod") influence what plants live in a wetland and how densely and how lushly they grow; what aquatic life and terrestrial life lives or feeds there; the accumulation of organics; and the ability of a wetland to process nutrients. Sediment in stormwater can change the size of sediment particles in a wetland, which determines the drainage characteristics. Suspended solids that settle on a wetland can lead to the incorporation

**See Appendix D for  
Wetlands Fact Sheet**



of heavy metals, hydrocarbons, nutrients, and bacteria into the soil, in turn affecting the life of the wetland and its water quality benefits to the stream.<sup>37</sup>

**f. Water Polluted**

The peak rate/detention basin approach fails to address the water quality impacts of stormwater runoff. Water that once infiltrated and was cleansed as it passed through the soil mantle is now discharged directly to streams. Runoff which once would have taken a meandering and more indirect path to the streams (providing additional opportunity for storage, infiltration, evaporation, and pollutant removal) is now given a direct route. The result is more and dirtier water directly entering the waterway over a longer period of time. The water quality impacts on streams can be devastating.

The nonpoint source pollution that is generated by stormwater runoff is persistent and invasive. Stormwater washes a myriad of pollutants from urban/suburban areas during a rain including: sediment, soils, nutrients (including phosphorus and nitrogen), copper, zinc, and other heavy metals (including lead), fecal coliform bacteria, hydrocarbons-oils-greases, atmospheric deposition, vehicle emissions, pavement deterioration, tire and brake pad dust, pet waste, chemicals and fertilizers used in lawn care, road salts and de-icing chemicals and their agents, household chemicals, organic and inorganic debris. Stormwater also increases temperatures.<sup>38</sup> Pollutants washed from agricultural areas include: sediments, animal wastes, plant residues, fertilizers, pesticides and fungicides with mixing agents and surfactants, solid waste, biological agents, and various bacteria and pathogens.<sup>39</sup>

**TABLE 2-4  
Six Pesticides Found Frequently In Stormwater Samples**

<b>Pesticide Name</b>	<b>Human Health and/or Environmental Effects</b>
2,4-D	Associated with lymphoma in humans; testicular toxicant in animals.
Chlorpyrifos	Moderately toxic to humans; neurotoxicant; can be highly toxic to birds, aquatic organisms, and wildlife.
Diazinon	Moderately toxic to humans; neurotoxicant; can be highly toxic to birds, aquatic organisms, and wildlife.
Dicamba	Neurotoxicant; reproductive toxicity in animals; association with lymphoma in some human studies.
MCPA (Methoxane)	Low toxicity to non-toxic in test animals, birds, and fish; suspected gastrointestinal, liver, and kidney toxicant.
MCPP (Mecoprop)	Slightly to moderately toxic; some reproductive effects in dogs; suspected cardiovascular, blood, gastrointestinal, liver, kidney, and neurotoxicant.

**Pesticides found frequently in stormwater samples.**

*Reprinted from "Stormwater Strategies, Community Responses to Runoff Pollution, NRDC, May 1999, based on work by T.R. Schueler, Extoxnet and Environmental Defense Fund.*



*Conventional detention basins have. . .*

*“low flow channels”  
leading to . . .*



*outlet works*



*leading to . . .*

*stormwater outfalls*



*leading to . . .*

*destroyed streams*



**Impacts of stormwater on stream habitat:**

- ✓ Increased nonpoint source pollution
- ✓ Accelerated bank erosion
- ✓ Increased siltation (burial of stable habitats)
- ✓ Elimination of meanders (channelization)
- ✓ Channel widening
- ✓ Reduced depth
- ✓ Reduced base flow
- ✓ Loss of shade
- ✓ Increased temperature
- ✓ Degradation of wetlands

*DNREC and Brandywine Conservancy, "Conservation Design for Stormwater Management; A Design Approach to Reduce Stormwater Impacts from Land Development and Achieve Multiple Objectives Related to Land Use", September, 1997, p. 1-17*

The effects of these pollutants are: sedimentation (or silting in) of streams and in-stream habitats; thermal stress; nutrient enrichment; oxygen depletion in surface water; toxic contamination of water supplies, aquatic life, and the food chain; pathogenic contamination of water supplies, fish, wildlife, and domestic animals.<sup>40</sup> Waterways used for recreation become unsuitable and the quality of life for human communities declines with growing odors, algae blooms, aesthetic degradation and the psychological impacts of knowing a stream is polluted and its life destroyed.

**g. Water Quality Costs**

Stormwater control, and stream and wetland protection go hand in hand. Poorly controlled stormwater causes nonpoint source pollution, which directly damages water quality. It also interferes with groundwater infiltration, which reduces aquifer recharge and stream base flow. In 1994, USEPA stated "nonpoint source pollution is now the number one cause of water quality impairment in the U.S., accounting for the pollution of about 40% of all waters surveyed across the nation".<sup>41</sup> As a result,

36% of the nation's surveyed river miles, 37% of the surveyed lake acreage, and 37% of the surveyed estuarine square miles are not safe for basic uses such as swimming and fishing.<sup>42</sup> (In most states a good proportion, if not most, of the waterways have yet to even be surveyed.)

In the State of Delaware "approximately 70% of the macroinvertebrate community found in streams of undeveloped forested watersheds were comprised of pollution sensitive mayflies, stoneflies, and caddisflies compared to 20% for urbanized watersheds. The pollution sensitive organisms were replaced by pollution tolerant species such as midges, worms and snails.

*DNREC and Brandywine Conservancy, "Conservation Design for Stormwater Management; A Design Approach to Reduce Stormwater Impacts from Land Development and Achieve Multiple Objectives Related to Land Use", September, 1997, p. 1-18 1-18 citing Maxted and Sharer 1996*

In the Delaware River watershed the picture is quite the same. In New Jersey, where only 59% of rivers and streams and no lakes have been assessed for water quality, sixty-five percent of New Jersey's assessed waterways<sup>43</sup> fail to meet water quality standards. In Pennsylvania, where only 15% of the waterways have been assessed for water quality, approximately 1/3 of those assessed fail to meet standards.<sup>44</sup> In Delaware 98% of the stream miles and 80% of the surveyed lakes (over 90% of these resources have been assessed) fail to meet water quality



standards.<sup>45</sup> In New York State, the Nationwide Urban Runoff Program (NURP) confirmed that pollutants washed from the land in stormwater impair water quality in New York's streams. According to the EPA, in New York City the runoff from the first hour of a moderate-to-heavy storm contributes more pollution than would the City's untreated sanitary sewage during the same period of time.<sup>46</sup> In order to address continuing pollution problems in the Delaware River watershed, which feeds New York City's reservoirs supplying six million residents with drinking water, new water quality regulations have gone into effect. For instance, any construction project within this 2,000 square mile watershed that creates more than 40,000 square feet of impervious surface must prepare a stormwater pollution prevention plan and meet other water quality regulations. This and other measures have become necessary to save New York City's drinking water supply.<sup>47</sup>

"Converting a forest to homes on one acre lots can result in a 12-fold increase in nutrient loads"

*"How much Development is Too Much for Streams, Rivers, Lakes, Tidal Waters and Wetlands?", Community and Environmental Defense Services, Maryland Line, MD.*

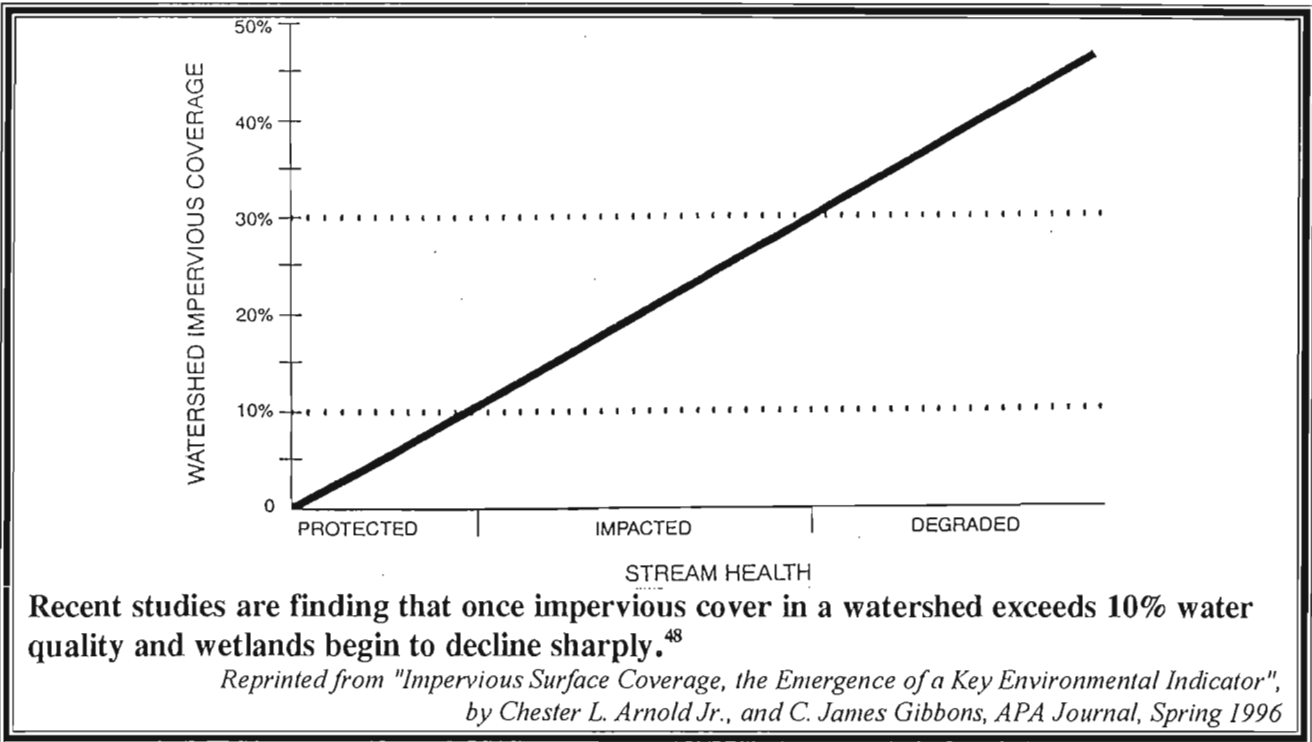

The impact of stormwater runoff caused by human development and deforestation is so pervasive and abundant that impervious surface coverage is emerging as a key environmental indicator that can be used to measure the prospects for the survival of a watershed's health. Research demonstrates a strong correlation between the imperviousness of a drainage basin and the health of its receiving stream.<sup>49</sup> Degradation of streams and wetlands begins when impervious surface reaches 10%.<sup>50</sup> Some estimates are emerging as low as 8%. Watershed imperviousness of 4% (one house on every 2 acres) can cause impairment for sensitive aquatic species.<sup>51</sup> At 25% imperviousness, fish die. At 30% coverage, the degradation is severe.<sup>52</sup>



The least costly and most effective best management practices ("BMPs") control pollutants at their sources.<sup>53</sup> It has been demonstrated that water quality is closely related to how land is developed. Density of development and the percent of impervious surfaces in a completed development site directly impact water quality.<sup>54</sup>

### **3. Where Do We Go From Here?**

Sprawling development is destroying our watersheds and quality of life. Development should not be accepted as inevitable. Communities need to take control. Nature's ability to support and/or accommodate new development must be a controlling factor in the planning process.

When development does take place, it does not have to be as destructive as it is today. It does not have to cause such a large increase in flooding. It does not have to destroy water quality. And we CAN go back and fix many of the problems of the past. But how?

- ✓ The first step is to understand the problems, causes and the most effective solutions.
- ✓ The second step is to prevent future destruction because it is much easier to prevent a problem than to fix one.
- ✓ The third step requires going back and fixing the problems we have.

We have already talked about the problems and the causes, now let's talk solutions.



## Chapter 2: Stormwater Runoff -- the Community Asset

### *Preventing, Capturing and Recovering the Lost Resource*

If we are to truly address the growing problems of flooding, drought and degraded water quality, we must look for a comprehensive approach that will address the real cause -- increased stormwater runoff. Stormwater runoff prevention, infiltration and best management practices (BMPs) are effective solutions for all of these stormwater runoff problems.

Preventing stormwater runoff in the first place through sound development practices which protect and restore vegetated landscapes and the environment's natural ability to infiltrate rainfall allows us to avoid the water quality and hydrologic impacts that runoff creates. Approaches that protect and restore infiltration of stormwater also recharge aquifers, filter out pollutants, reduce flooding and feed groundwater to streams during dry times. Stormwater BMPs include a variety of building, engineering and commonsense techniques which can effectively protect and enhance infiltration of rainfall and filter out nonpoint source pollution.

Stormwater BMPs can be implemented in new developments, but can also increase infiltration in existing ones. Stormwater BMPs mimic natural systems, relying upon the land's natural ability to soak up and treat rainfall. In many cases, stormwater BMPs save money and increase property values.

"If we respect the natural value of our groundwater, streams and riparian corridors and realize the development potential of working with the natural system, our communities will be more livable and desirable."

*Droughts, Floods and Sprawl --  
They're all connected,  
EPA Watershed Events, US EPA  
Office of Water, Summer 2000,  
EPA 840-N-00-001.*

Implementing a watershed-wide, comprehensive stormwater management plan, taking into consideration the water quantity, quality and habitat impacts of stormwater runoff, will provide the best results. A comprehensive approach to stormwater management should include:

- ✓ Implementing a minimum disturbance/conservation or open space design approach to new development and redevelopment projects;
- ✓ More stringent municipal ordinances, and regional and state plans, that require infiltration FIRST and detention IF AND ONLY IF infiltration is not possible and which encourages developers to preserve the natural properties of a site;
- ✓ Protecting and reforesting open space areas;
- ✓ Protecting existing native vegetation including woodlands, meadows and reforesting lawns on public and private lands;
- ✓ Cooperative watershed-based, inter-municipal stormwater planning;
- ✓ Protecting and creating forested buffers along waterways;





- ✓ Retrofitting detention basins to encourage stormwater infiltration and/or retention;
- ✓ Use of porous pavement with recharge technology in new development projects, redevelopment projects, expansions, or repairs;
- ✓ Incorporating vegetated filter strips into existing and new development projects;
- ✓ Introducing bio-retention areas into new and existing developed areas;
- ✓ Use of swales and french drains along parking areas and other large paved surfaces and/or routing (or re-routing) their runoff into vegetated areas;
- ✓ Introducing infiltration trenches to existing developments and retrofitting existing drainage systems so they incorporate infiltration trenches (i.e. replace sections of existing drainage systems with porous materials);
- ✓ Programs for re-routing rooftop runoff into gardens, vegetated areas or recharge systems;
- ✓ Use of vegetated roof covers;
- ✓ A comprehensive floodplain protection, buyout and restoration program;
- ✓ A comprehensive education program for watershed residents including: education about the benefits of revegetating lawns; re-routing rooftop runoff and sump-pump discharges into gardens and other vegetated areas as opposed to storm sewers; using rain barrels to capture and allow reuse of rainfall; creation of rain gardens; the use of native plant species; and wetlands and floodplain protection programs.

**Definition:** Bio-retention areas -- "A water quality practice that utilizes landscaping and soils to treat urban stormwater runoff by collecting it in shallow depressions before filtering through a fabricated planting soil media".

*2000 Maryland Stormwater Design Manual, MDE, Volume I, glossary, draft, 1999.*

While this list is by no means exhaustive, at a minimum these items should be included in any stormwater management plan and approach.

Experts, environmentalists and forward-thinking states like Maryland recognize the serious shortcomings of the traditional stormwater management approach which focuses only on peak flows and is primarily designed to detain runoff for a limited period of time. They are now calling for use of infiltration techniques. The Delaware Estuary Program, developed with the United States Environmental Protection Agency, advocates the use of BMPs to help the hydrologic cycle function as nature intended. The Delaware Estuary Program recognizes that in order to clean up the Delaware bay and estuary, nonpoint source pollution and stormwater runoff need to be addressed on the urban fringe, where land use is changing, and in the urban setting, where BMP's should be used to retrofit existing peak rate systems so natural stream systems can be restored.<sup>55</sup>



## A. Infiltration -- A New Dominant Paradigm Emerges

*"Infiltration calls forth the natural powers of soil and vegetation to restore environmental health. By returning runoff to the earth, it eliminates pollutant discharge, eradicates floods, replenishes ground water supplies and restores aquatic habitats."<sup>56</sup>*

Infiltration practices allow rainwater to percolate through the soil profile to recharge the groundwater aquifer. By preserving the natural conditions that promote recharge and/or creating systems designed to capture rainfall and promote its infiltration, infiltration practices mimic nature.

Protecting and restoring the natural absorbency of the land and using techniques which infiltrate water back into the ground is a comprehensive solution which addresses both water quantity and water quality issues. Unlike any other approach to stormwater management, infiltration is capable of addressing many issues at once: controlling peak runoff flow; protecting stream base flow, stream channel stability and water quality; curbing streambank erosion; encouraging ground water recharge,<sup>57</sup> supporting ecosystem health, and contributing to the scenic beauty of stream valleys. Infiltration restores aquatic and wildlife habitats and biodiversity, enhances water quality, protects floodplains and streambanks, and adds to open space.<sup>58</sup> "Infiltration is not just a means of mitigating the hazardous aspects of stormwater; it is a means of reclaiming water resources and rehabilitating urban watersheds."<sup>59</sup> It is the only known method of reducing runoff volumes, restoring groundwater recharge, augmenting stream flow and preserving the hydroperiod of downstream wetlands. It is more effective than detention in controlling urban flooding and drainage problems and is a means of restoring compromised watersheds.<sup>60</sup>

**Definition:** Infiltration -- "the downward movement of water from the surface of the land to subsoil. The infiltration capacity is expressed in terms of inches/hour"

*Reducing Impacts of Stormwater Runoff from New Development, NYDEC, 1992*

**When its application is possible, stormwater infiltration is the most effective stormwater strategy and one that can be accommodated through a large variety of best management practices (BMPs) that range from design and building techniques which protect natural areas to construction of large porous paving projects.**

Infiltration can be accomplished through one BMP or a combination of treatment systems designed to recharge and clean stormwater. The cost need not be any more than traditional infrastructure.<sup>61</sup>

**Recommended Reading:**

*Bruce K. Ferguson,  
Stormwater Infiltration,  
CRC Press. 1994*

## 1. Infiltration Improves Water Quality

On comparison, stormwater infiltration measures remove far greater levels of pollutants than traditional approaches to stormwater management. While traditional approaches actually exacerbate water quality problems and deliver more pollutants to our stream systems, infiltration utilizes and takes advantage of the physical, chemical and biological powers of soil to trap and transform pollutants before they can enter aquifers or streams.<sup>62</sup>

### **a. The Renovating Capabilities of Soil**

"The soil mantle offers critical pollutant removal functions through physical processing (filtration), biological processing (various types of microbial action), and chemical processing (cation exchange capacity, other reactions)."<sup>63</sup>

The cation exchange capacity (CEC) of soil measures its ability to cleanse pollutants from infiltrating stormwater. "CEC values typically range from 2 to 60 milliequivalents (meq) per 100 grams of soil."<sup>64</sup> "A value of 10 is often considered to be the minimum necessary to accomplish a reasonable degree of adsorption-related pollutant removal."<sup>65</sup> Coarse, sandy soils are not particularly good at removing pollutants from stormwater and therefore have low CEC values.<sup>66</sup> Soils such as clays have much higher CEC values and are more effective at pollution removal.<sup>67</sup>

"With an infiltration-based approach, pollutant removal relies on the natural renovating capabilities of the soil mantle, cation exchange, action by aerobic and anaerobic bacteria, physical filtering of particulates, and chemical precipitation."

*Stormwater Management in the New Jersey Coastal Zone, Prepared by Cahill Associates for NJ DEP, April 1989*

The bacteria, fungi, actinomycetes, and algae in soil are a part of its complex and valuable ecology that can help process and remove pollutants found in stormwater runoff.<sup>68</sup> Similarly, plants provide substantial pollutant removal potential, through physical filtering, biological uptake of nutrients, and chemical interactions.<sup>69</sup>

There are only a few site conditions that discount infiltration as an option:<sup>70</sup> ✓ Toxic wastes in industrial areas that would leach; ✓ Saline deposits in arid areas that would leach; ✓ Steep, unstable slopes; ✓ Close proximity to basements, sensitive structural foundations, water supply wells or septic fields.

Infiltration is not generally recommended in highly industrialized areas unless there has been prior testing of the runoff for pollutants and the potential for soil and groundwater contamination has been appropriately considered.<sup>71</sup>

### **b. Filtering out the First Flush of Pollution**

About 96% of all rainfall in this region falls in storms that are less than a 3-year event. These smaller storm events are responsible for a major part of water quality problems because it is

the "first flush" of the storm -- the first wash over the land -- that carries the bulk of the pollution including solids, microorganisms, metals, nutrients and organic compounds. These smaller storms regularly wash off the pollution collected on the land. Because many conventional stormwater systems, focused mainly on peak flow, pass these smaller storm events unimpeded, the result is that the pollutants they carry from impervious surfaces are dumped directly and untreated into our waterways and ecosystems. Significant pollutant removal can be provided with infiltration designed for a small quantity of runoff, such as all storms up to the 2-year storm.<sup>72</sup>

**Definition:** First flush -- "refers to the delivery of a disproportionately large load of accumulated pollutants that are washed from the surface of the land during the early part of storms and transported as runoff."

*Reducing Impacts of Stormwater Runoff from New Development, NYDEC, 1992*

## **2. Infiltration Reduces Flooding by Decreasing Both Stormwater Runoff Volume and Peak Flow Rates ...**

### ***a. ... by putting rainfall back into the ground.***

Much of the flooding experienced today is caused by a greater volume of water entering our stream systems over a longer period of time. Increasing runoff is directly correlated to decreasing infiltration of rainwater into the ground. Infiltration measures allow rainfall to recharge the natural soil-sponge that regulates the hydrologic balance of a watershed. Infiltration reduces flooding by eliminating excess runoff in a storm. Infiltration can reduce the peak rate and flow volume to pre-development conditions for 2-year storms up to 100-year storms.<sup>73</sup>

"Infiltration is capable of reducing volume and peak rate of storm flow at the point of discharge and consistently downstream, eliminating all cases of aggravated urban flooding and drainage problems."

Bruce K. Ferguson, **Stormwater Infiltration**, CRC Press, 1994, p.171.

A 1-year storm event is 2.5 inches of rainfall within 24 hours.

A 2-year storm event is 3.2 inches within 24 hours.

*Stormwater Management Systems,  
Porous Pavement System with  
Underground Recharge Beds,  
Engineering Design Report, Cahill  
Associates, Spring, 1993*

Two-year storms are responsible for a good portion of the flooding and erosion which stormwater management tries to address. Because the force and volume of a 2-year storm increases as impervious surfaces increase, and because 96% of all rainfall in our region is delivered in storms smaller than the 3-year storm, the need to address the 2-year storm grows as suburban sprawl and land use disturbance increases. Infiltration measures are designed to capture the increased runoff that results from development. By including infiltration designs that at least address the 2 to 3-year events, not only do we

largely address the water quality problems associated with stormwater runoff but we also restore the bulk of the rainfall to the natural hydrologic cycle.



Infiltration BMPs that retain the runoff from a 2-inch rainfall can reduce the annual storm runoff volume by 95%.<sup>74</sup> Similarly, infiltration BMPs that retain the runoff from a 1-inch rainfall, can reduce the annual storm runoff volume by 75%.<sup>75</sup> Because infiltration BMPs and conservation design techniques put storm runoff volume back into the soil and prevent runoff impacts, they are very effective at controlling the smaller storms and realizing the benefits of rainfall-turned-recharge.<sup>76</sup>

**b. ... by restoring a natural path.**

When rain is infiltrated on site, the time of concentration of stormwater flow is extended, allowing the peak flow rate from a site to be reduced.<sup>77</sup> By elongating the route stormwater takes through vegetation, whether established meadow, scrub or forest, resistance is increased, infiltration is provided and time of concentration is increased.<sup>78</sup> To accomplish this, stormwater BMPs should attempt to lengthen (as closely as possible to pre-development conditions) the path of the stormwater before it is discharged to the creek. Conventional development uses pipes, curbing and gutters in order to actually shorten this route. As a result, the peak rate created by conventional development is greater than what can be achieved through the use of BMPs.

**Definition:** Time of concentration - "time required for water to flow from the most remote point of a watershed [or site], in a hydraulic sense, to the outlet [or waterway]".

*2000 Maryland Stormwater Design Manual, MDE, Volume I, glossary, draft, 1999.*

### **3. The Success of the Infiltration Approach Requires Informed Implementation**

The spaces found between soil particles are called pores. Air and water are contained in soil pores. These pores allow rainfall to soak into the ground rather than run off the surface.

DNREC and Brandywine Conservancy, "Conservation Design for Stormwater Management; A Design Approach to Reduce Stormwater Impacts from Land Development and Achieve Multiple Objectives Related to Land Use", September, 1997, p. 2-27

Effective stormwater infiltration requires considering and working with the existing soils on a site. Some soils are better than others at infiltrating water and removing pollutants, so each infiltration method used must be designed to work with the soils on that particular site.

The amount of water that infiltrates into the ground (the "infiltration capacity") is determined by a variety of factors: the soils that are present; the duration and intensity of precipitation; the prior wetted condition of the soil; the amount and type of vegetation; soil mineralogy and texture; the land surface slope; and the geology underlying the soil.<sup>79</sup> Other factors including controlling the degree of soil compaction, the shape of soil particles and the amount of organic materials<sup>80</sup> are also important.

In order to help identify those soils that are most conducive to infiltration, the Natural Resources Conservation Service has classified soils into four categories depending on the soil's



infiltration rate after a prolonged period of wetting. The categories are A, B, C and D, with the highest infiltration capacity being Type A and descending with each class.<sup>81</sup> Soil type is an important factor: sands, loamy sands, and silts, have higher infiltration rates than clays and silty clays, in part due to the amount of void space (soil porosity) available among soil particles for infiltration and storage of water.<sup>82</sup>

✓ Group A soils have high infiltration rates and low runoff potential even when thoroughly wetted. This group generally includes gravels and sands. Sand, loamy sand, or sandy loam.<sup>83</sup>

✓ Group B soils have moderate infiltration rates when thoroughly wetted. Soils in this group are moderately fine to moderately coarse textures. Silt loam or loam.<sup>84</sup>

✓ Group C soils have low infiltration rates when thoroughly wetted. This group generally contains soils that have a layer that impedes the downward movement of water. Soils are moderately fine to fine texture. Sandy clay loam.<sup>85</sup>

✓ Group D soils have very low infiltration rates when thoroughly wetted and have high runoff potential. This group chiefly consists of "clay soils with a high swelling potential, soils with

#### Definitions:

Infiltration: "The downward entry of water through the soil surface into the soil."

Permeability -- "The specific soil property designating the rate at which gases and liquids can flow through the soil."

"Infiltration refers to the passage of water into the soil surface while permeability refers to the rate which water passes through a specific soil."

*DNREC and Brandywine Conservancy, "Conservation Design for Stormwater Management; A Design Approach to Reduce Stormwater Impacts from Land Development and Achieve Multiple Objectives Related to Land Use", September, 1997, pgs. 2-27 & 2-29*

a permanent high water table, soils with a claypan or clay layer at or near the surface, and shallow soils over nearly impervious material." Clay loam, silty clay loam, sandy clay, silty clay, or clay.<sup>86</sup>

Successful rainfall infiltration is not limited to Types A and B soils (which have the optimum infiltration rate of about 0.25 inches per hour).<sup>87</sup> Rain falling in a forest is absorbed and infiltrates despite the type of soil present. Simply stand in a forest while it is raining. There is no runoff until the underground aquifers are full—the forest is drinking the rainfall.

It is a common misconception that Type C and D soils cannot effectively infiltrate rainfall, when in fact a questionable C or D soil that is not disturbed and is reasonably well vegetated can be quite effective at infiltrating captured stormwater runoff created by new impervious cover.

*DNREC and Brandywine Conservancy, "Conservation Design for Stormwater Management; A Design Approach to Reduce Stormwater Impacts from Land Development and Achieve Multiple Objectives Related to Land Use", September, 1997, p. 3-5*

How much percolates through before running off is a function of vegetation, groundcover and forest floor debris, the underlying geology and subsurface soils,<sup>88</sup> slope, the depth of the soil



mantle, and the depth to groundwater. **Type C and D soils may be suitable for stormwater infiltration systems if combined with proper vegetation, subsurface soils and geology.**<sup>89</sup>

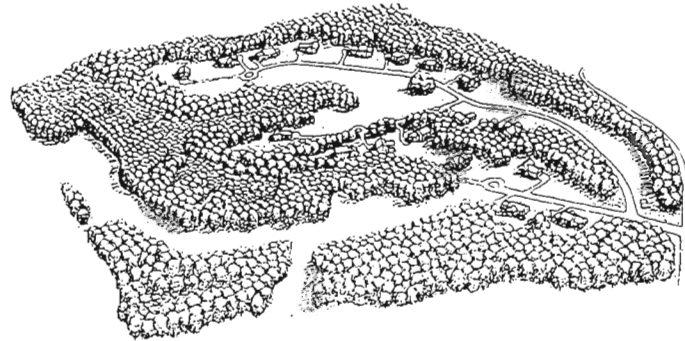

**By preserving existing site features such as soil mantle, natural contours and forest cover, a development design can protect the land's ability to absorb rainfall, prevent runoff, and effectively integrate nature's stormwater management abilities into the design.**

*Graphic by Stephen Kuter, Natural Lands Trust, Media, PA*

The key is to design infiltration systems with existing conditions.

- ✓ Preserve areas with established forest cover. Vegetation increases the permeability of a site by providing "viscous fingers" which work as part of the soil mantle to catch and absorb precipitation. This living fabric which covers the forest floor is made up of insects, roots, burrowing animals, nesting birds, fungi and bacteria which all work to provide millions of pathways for rain to filter through to the groundwater below--increasing the native soil's ability to infiltrate.<sup>90</sup> Forest-covered soils can sometimes even absorb more than their share of precipitation. "With a well developed litter layer, infiltration capacities of forest soils generally exceed rainfall and can absorb overland flows from adjacent lands."<sup>91</sup>
- ✓ Use soils with the greatest infiltration ability for stormwater management.
- ✓ Protect soils on site. "Infiltration rates can be significantly reduced as a result of structural damage to the soil surface by traffic across that surface. The permeability of a specific soil may be high but the infiltration rate into the soil is significantly reduced by sealing of the surface due to imperviousness or compaction."<sup>92</sup> Therefore, during construction and maintenance it is critical that soil compaction be avoided at all cost, and if necessary, that compacted soils be rehabilitated.

"To say that it is not feasible to use fine-textured soils for infiltration because it is slowly permeable is like saying it is not feasible to use corrugated metal pipes for carrying water because corrugated metal has a high roughness factor and therefore carries little water. Corrugated metal pipes are in fact [widely] used....Roughness is taken into account in pipe design."

*Bruce K. Ferguson, Stormwater Infiltration, CRC Press, 1994, p. 177*

✓ Design with existing soil mineralogy and texture

✓ Consider land surface slope.

When existing conditions are not optimal, stormwater infiltration systems can be designed to compensate for what is lacking. For example, improving the infiltration capabilities of C or D soils by reforestation, or accommodating steep slopes and other limiting site factors using a series of integrated BMPs.

Infiltration practices are an underutilized set of stormwater management practices. Many infiltration practices are low cost, have less "hard" infrastructure and expensive engineering and have low to moderate maintenance requirements.<sup>93</sup> When properly sited, designed, installed, and maintained, infiltration techniques are among the most efficient means of reducing stormwater runoff and flooding.

Hydrologic or Water Quality Parameter	Parking Lot	Meadow
Curve number (CN)	98	58
Runoff coefficient	0.95	0.06
Time of concentration (minutes)	4.8	14.4
Peak discharge rate, 2-yr, 24-h storm (cu. ft/s)	4.3	0.4
Peak discharge rate, 100-yr storm (cu. ft/s)	12.6	3.1
Runoff volume from one-inch storm (cu. ft)	3450	218
Runoff velocity @ 2-yr Storm (ft/s)	8	1.8
Annual phosphorus load (lbs/ac/yr).	2	0.10
Annual nitrogen load (lbs/ac/yr).	15.4	0.8
Annual zinc load (lbs/ac/yr)	0.30	ND
Key Assumptions: <b>Parking Lot:</b> 100% impervious, 3% slope, 200 ft flow length, Type 2 Storm, 2-yr, 24-h storm = 3.1 in., 100-yr storm = 8.9 in., hydraulic radius = 0.3, concrete channel, suburban Washington 'C' values. <b>Meadow:</b> 1% impervious, 3% slope, 200 ft flow length, good vegetative condition, B soils, earthen channel.		

**Comparison of one acre of parking lot versus one acre of meadow.**

*Site Planning for Urban Stream Protection,  
by the Center for Watershed Protection, co-published by the Metropolitan  
Washington Council of Governments, December 1995*





## B. Protecting and Restoring Natural Stormwater Patterns

*By improving the integrity of our water resources while reducing the potential damages from storms and droughts, the economy will be strengthened.*

*Droughts, Floods and Sprawl -- They're all connected, EPA Watershed Events, US EPA Office of Water, Summer 2000, EPA 840-N-00-001*

Detention basins, dams, levees and the many other standard structural solutions are temporary band-aids that fail to address the causes of excessive stormwater runoff. While they may hold water back for a little while they still allow stormwater volume to increase, nonpoint source pollution to increase, and infiltration to groundwater to decrease. By comparison, a combination of preventive and mitigative stormwater best management practices (BMPs), which encourage rainfall infiltration to the greatest extent possible, have the ability to reduce the volume of runoff, minimize stormwater-induced nonpoint source pollution and encourage recharge of groundwater aquifers.

The goals for effective implementation of stormwater best management practices are to first **protect** and second **restore** the natural stormwater patterns existing on a site in its natural state including infiltration to the aquifer, filtration of nonpoint source pollution, and moderation of runoff peak velocities and volumes.<sup>94</sup> BMPs include minimum disturbance techniques on new development as well as infiltration and water quality-focused techniques on new and existing development.

The least costly and most effective stormwater management technique is protecting the hydrologic function of a site by preserving natural areas and areas that most effectively infiltrate stormwater. This minimizes the amount of land disturbed and the amount of impervious cover in a development.

To the extent prevention is not possible, either because development has already occurred or because some disturbance of the site is required in order to achieve the proposed development, every effort should be made to restore natural function to damaged areas -- for example by reforesting disturbed areas and rehabilitating compacted soils. A comprehensive stormwater

### What is a Stormwater Best Management Practice (BMP)?

A best management practice is an environmental protection measure used to reduce the impact of watershed development upon water resources, including the aquatic community. A stormwater best management practice is designed to prevent soil and pollutants from running off the land and into a waterway and to allow rainfall to penetrate the soil mantle, keeping the hydrologic cycle in balance.

*"How Much Development is Too Much for Streams, Rivers, Lakes, Tidal Waters and Wetlands?", Community and Environmental Defense Services, Maryland Line, MD*



approach works to mimic the natural system by recreating opportunities to capture and infiltrate runoff as close to its point of origin as nature would.

Reducing stormwater runoff using stormwater infiltration techniques not only addresses the flooding, erosion and siltation issues associated with runoff, but it ensures aquifer recharge thereby protecting stream base flow and drinking water supplies. At the same time, infiltration BMPs are the most effective means for reducing nonpoint source pollution thereby protecting water quality and helping communities meet regulatory requirements to improve and protect stream water quality.

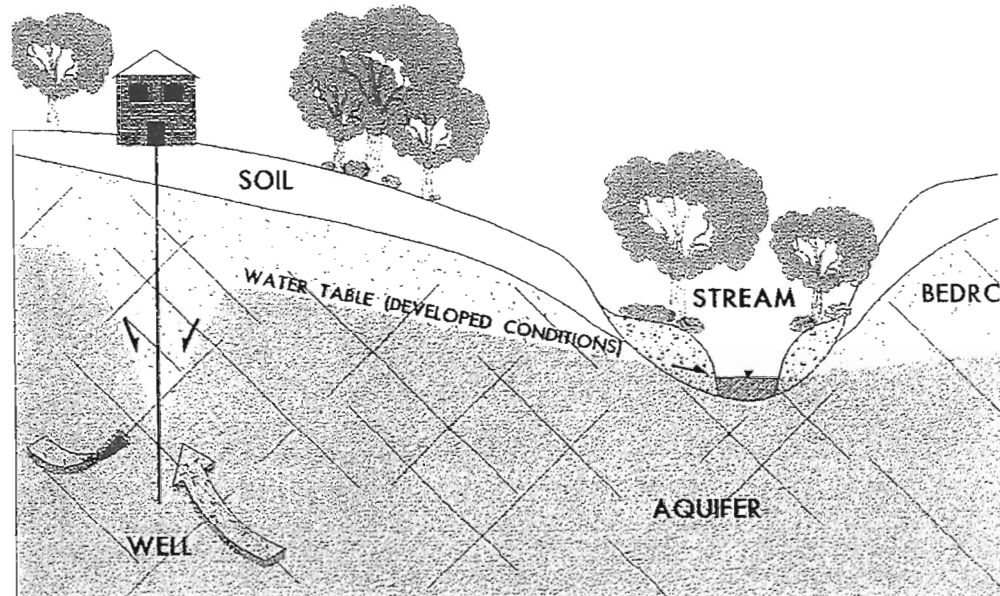

*Cahill Associates, 2001*

A comprehensive BMP approach recognizes that often one stormwater facility or approach cannot address all the issues of concern. For example, a system designed to capture phosphorus that generally occurs in a particulate form bound to soil particles, will not effectively address nitrogen pollution that is generally found in soluble form, requiring anaerobic conditions where de-nitrification can take place.<sup>95</sup> Therefore, a BMP approach often encourages the use of treatment trains -- a series of systems designed to work together to remove a variety of pollutants of concern.

The cost of stormwater controls today has risen. In the past, the required conventional controls were about 25% of the construction cost. Today, conventional stormwater controls are about 32% of the base construction cost.<sup>96</sup> Because use of conservation design/minimum disturbance practices and infiltration BMPs afford better performance than conventional stormwater infrastructure it is a better investment for both the developer and the community. The developer may even save money since less land and equipment will be needed for stormwater infrastructure (i.e. no basin, pipes, culverts; less land grading; and less stormwater runoff to manage). In the long run, the infiltration BMP approach is also less costly for the resident and homeowner, the municipality, and/or the entity (private or public) which must maintain the stormwater controls and mitigate the impacts of stormwater on the watershed.



*Effective design can . . .  
leave wooded stream corridors intact;*



*put infiltration trenches into existing woodlands.*



*Conservation design eliminates wide pavement and curbing.*



*Revegetated lawns infiltrate rainwater and enhance quality of life.*



## Chapter 3. Transforming the Lost Resource into the Community Asset: *Accomplishing Infiltration, Filtration and Recharge*

### A. Minimum Disturbance in New Developments -- the Best Management Practice

The most effective way to minimize stormwater runoff is to prevent it<sup>97</sup> by minimally disturbing the site so as to preserve its natural infiltration capacity. This approach addresses both the construction impacts as well as the long-term impacts of development and it reduces stormwater runoff while improving water quality.

Also known as conservation or open space design, minimum disturbance is an approach to land development that looks at the land and attempts to understand how nature is balancing the hydrologic cycle on that piece of the watershed. Effective use of conservation design reduces the total volume of stormwater runoff, mitigates peak rate impacts by increasing time of concentration (see box page 21), and effectively minimizes a host of water quality, water temperature, and other vital water resource impacts.<sup>98</sup> By using approaches and practices that can be combined in a variety of ways in order to minimize the impacts of development and present a cost-efficient and marketable finished product, this approach is only limited by the imagination of the builder and the flexibility of the regulatory agencies.

#### **What is Conservation/Open Space/Minimum Disturbance Design?**

It is a "design approach to site development that protects and incorporates natural site features into the stormwater management plan."

*DNREC and Brandywine Conservancy,  
"Conservation Design for Stormwater  
Management; A Design Approach to  
Reduce Stormwater Impacts from Land  
Development and Achieve Multiple  
Objectives Related to Land Use",  
September, 1997*

Conservation design ensures that stormwater management is included as part of the site design process itself, not merely as an afterthought. The conservation design approach is often less expensive than conventional development, incorporating stormwater control techniques that improve over time, rather than deteriorate like conventional detention basins.<sup>99</sup> The goal is to

maximize existing vegetation -- preferably native vegetation -- and to minimize the creation of an artificial landscape.<sup>100</sup> The result is that you avoid the negative impacts of land disturbance while benefiting from the rewards of a natural, healthy functioning ecosystem.<sup>101</sup>

In addition to using a minimum disturbance approach to development, it is

#### ***Recommended Reading:***

*DNREC and Brandywine Conservancy,  
"Conservation Design for Stormwater  
Management; A Design Approach to  
Reduce Stormwater Impacts from Land  
Development and Achieve Multiple  
Objectives Related to Land Use",  
September, 1997*



also important to try to center development around a community's existing development -- this reduces sprawl growth and impervious cover and allows the protection of natural resources. A recent Delaware Estuary Program (DELEP) study looked at communities promoting a pattern of mixed uses, open space and growth. The study found that concentrating growth in existing centers rather than promoting sprawl development "resulted in a savings of \$28.8 million in local road costs, \$9.1 million in annual water treatment costs, \$8.3 million in annual sewer treatment costs, as well as an 8.4% reduction in overall housing costs and a 6.9% savings in annual costs of local public sector services."<sup>102</sup> Even more importantly, these cost reductions enjoyed by properly concentrating growth are reinforced by compelling environmental benefits resulting from reduction in total land disturbed, total amount of impervious surface being created, and other important environmental impacts.

Policy makers are beginning to recognize the importance of conservation design and changes are being made at the visioning level. For example, the New Jersey State Development and Redevelopment Plan attempts to control sprawl development by calling for new growth and development to be centered around existing urban and already developed centers.<sup>105</sup> The plan proposes use of municipal master plans, regulations and public investment policy to shape future development in New Jersey. However, while the stated goals of this Plan are moving in the right direction, the Plan fails to include the detail, enforceability and implementation mechanisms necessary to realize the benefits of conservation design. And development forces have managed to force some conventional, sprawl-inducing development practices into the Department of Commerce's Residential Site standards guidelines. Progress has been made, but effective growth management is far from a reality across Delaware River watershed communities.

**The steps to follow when implementing conservation design:**

*Step 1* -- Conduct a full site analysis including inventorying all the natural systems on the site such as water, soil, geology, vegetation, habitat, cultural resources, socioeconomic factors.

*Step 2* -- Determine how to best prevent stormwater runoff during site design and the development process.

*Step 3* -- Determine what BMPs can be used to mitigate any stormwater runoff that will occur as a result of site development.

It is important to recognize that while site conditions such as woodlands, riparian buffers, and soils with maximum permeability, can be viewed as constraints because they should be protected from development, they can also be incorporated into the stormwater management approach used for the site. This allows these features to be viewed as tremendous opportunities, both in terms of stormwater management effectiveness, in terms of cost savings on stormwater infrastructure, and in terms of enhancing site marketability if developed properly.

*DNREC and Brandywine Conservancy, "Conservation Design for Stormwater Management: A Design Approach to Reduce Stormwater Impacts from Land Development and Achieve Multiple Objectives Related to Land Use", September, 1997*



### **Basic principles of conservation design:**

- ✓ Stormwater is a valuable resource that should not be wasted.
- ✓ Stormwater management should be incorporated early in site design and planning.
- ✓ Maintain the natural hydrologic regime, including essential elements of the water cycle, as carefully as possible.
- ✓ Prevention should take precedence over mitigation.
- ✓ Stormwater should be managed as close to the point of origin as possible since this best maintains the natural hydrology and costs less money.
- ✓ A conveyance and collection approach to stormwater management should be minimized since structural collection and conveyance systems (pipes, culverts, systems of inlets) are increasingly expensive both to construct and to maintain and because these systems increase flows and rate of flows exacerbating the problems caused by stormwater runoff.
- ✓ Natural processes within the soil mantle and plant communities should be used to the maximum extent possible.
- ✓ Systems should avoid concentrating and accelerating stormwater runoff flow.

*DNREC and Brandywine Conservancy, "Conservation Design for Stormwater Management; A Design Approach to Reduce Stormwater Impacts from Land Development and Achieve Multiple Objectives Related to Land Use", September, 1997*

## **1. Implementing Conservation Design and Minimum Disturbance for Development**

All pervious areas on a site are opportunities for maintaining and enhancing infiltration.<sup>104</sup> Before a development plan is prepared for a site and a stormwater management system is designed and long before a spade of earth is turned for a new development, the developer must understand the land and the natural systems that will be disturbed. When constructing, it is important to maintain the natural hydrologic function of a site by protecting its natural contours, vegetation, and all of its natural resources to the greatest extent possible.<sup>105</sup> Natural resources including wetlands and wetland buffers, floodplains, forested areas, meadows, riparian buffers, soils, steep slopes, natural depressions and other natural and unique features should be inventoried.<sup>106</sup> Setbacks and buffers from sensitive areas should be incorporated in the site design and implemented.<sup>107</sup>

The original site planning and design must analyze the existing topography and characteristics of the site. Highly vegetated areas should be preserved. Soils with the highest percolation rates should be left undisturbed. The natural topography should be maintained to the greatest extent possible, allowing natural depressions to continue to gather, hold and infiltrate water. Because conservation design reduces the quantity of runoff at the source, this means that less effort, infrastructure and money has to be invested in controlling it later.

The most effective way to prevent excessive stormwater runoff is to rely on natural infiltration using existing vegetative cover and undisturbed soils.<sup>108</sup> This approach requires that developers only clear the areas where building is intended and that the disturbance of soil be limited to carefully established distances from the proposed site structures and





improvements.<sup>109</sup> Once an area has been disturbed, it should be restored to the greatest extent possible by revegetating with native trees and shrubs. Native vegetation is better adapted to local climatic conditions and doesn't require as much watering or fertilization.

The condition of the land surface is very important to stormwater management. What is on the land surface and the condition of what is on the surface are both vital. Vegetated surfaces like woodlands and meadows slow surface runoff, promote natural infiltration back into the ground, and generally improve water quality in a number of different ways. This is especially true for smaller, more frequent storms, such as the 1-year storm (a rainfall of about 2.5 inches in a 24-hour period) which account for the vast bulk of the total rainfall occurring in a typical year in the Delaware River watershed.

Why vegetated areas should be protected:

- ☉ forest leaf canopy provides rainfall interception while the organic layer found on the forest floor acts as an effective sponge;
- ☉ trees use and store nutrients, provide shade to moderate water temperatures, and provide important wildlife habitat;
- ☉ wetlands provide flood control, augment low stream flows, provide erosion control, water quality and needed habitat.

*DNREC and Brandywine Conservancy, "Conservation Design for Stormwater Management; A Design Approach to Reduce Stormwater Impacts from Land Development and Achieve Multiple Objectives Related to Land Use". September, 1997. p. X-iii*

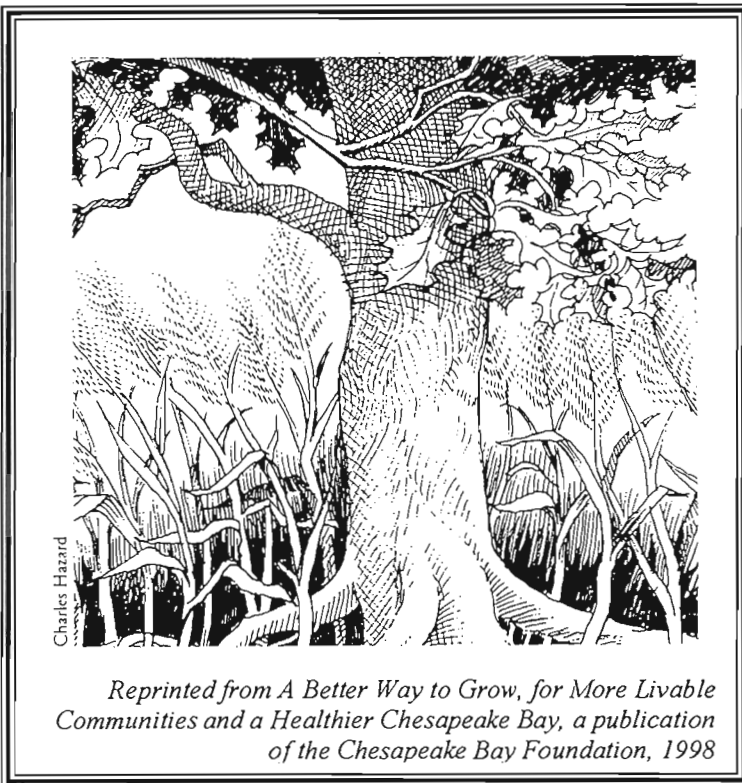

Minimizing site disturbance and maximizing conservation of existing vegetation is beneficial for several reasons. First, there is the question of the all-important "curve number". Stormwater calculation methodologies, such as the very popular Soil Cover Complex or TR-55 method, assign different "curve numbers" to different land surfaces. These curve numbers drive the calculation of stormwater runoff. Low curve numbers indicate low runoff generation and high curve numbers indicate large runoff volumes. The stormwater engineer is required to re-assign much higher curve numbers to naturally vegetated site areas when they are disturbed and made either impervious or re-lawnsaped. The



more area that gets disturbed, the greater is the volume of stormwater generated -- and the amount that must be managed. A minimum disturbance approach avoids much of this curve number reassignment and prevents stormwater from being generated in the first place.

Secondly, areas of existing vegetation that have not been disturbed provide excellent opportunity for stormwater management through a variety of infiltration practices. Through the use of berms and other types of simple level spreading devices, stormwater that cannot be prevented can be properly mitigated. The specific management techniques must respect the existing vegetation and soil to the maximum extent, lest their benefits be lost. But, typically, berms placed along natural contours or other types of spreading methods can be used to distribute stormwater with minimal structure and disturbance. Furthermore, presence of vegetation, such as meadow or forest, often substantially improves permeability of otherwise heavy soils and should therefore be left undisturbed.

Conservation design promotes the protection and/or restoration of trees and shrubs. Post-development lawns that accompany traditional development practices do not provide the kind of cover or root systems required to encourage maximum infiltration. Lawns generate significantly more stormwater runoff than meadow, scrub vegetation or forests,<sup>110</sup> and can approach the imperviousness of asphalt if soil had been severely compacted.<sup>111</sup>

Requiring open space to be preserved in its naturally vegetated state helps ensure maximum infiltration and environmental benefits. It is also less expensive to maintain. It costs about \$75 per acre per year to manage natural open space. To manage open space as turf increases costs significantly, up to \$240 to \$270 per acre per year. To manage for passive recreation such as trails and paths can cost up to \$200 per acre per year.<sup>112</sup> And costs increase up to \$1000/acre as artificiality increases.

"The combination of site compaction, site imperviousness, and reduced depression storage causes dramatic increases in downstream flood potential and channel erosion."

*DNREC and Brandywine Conservancy,  
"Conservation Design for Stormwater  
Management; A Design Approach to Reduce  
Stormwater Impacts from Land Development  
and Achieve Multiple Objectives Related to  
Land Use", September, 1997*

Under natural conditions, most sites have depressions that serve to capture and store rainfall, allowing time for evaporation and/or infiltration.<sup>113</sup> These areas, which are generally filled or drained during development, should be protected as part of the site design. To the extent that development destroys the natural depressions on a site, they can be replaced using careful grading, also known as "terraforming". In some instances, in low density residential settings, with lots of 1 acre or more, terraforming can be used to maintain the total development-induced volume for up to

the 2-year storm and controls peak flow rates for large storms up to the 100-year storm.<sup>114</sup>

Another advantage of conservation design is that it can minimize the need for conventional, structural stormwater control measures.<sup>115</sup> Structural stormwater control generally requires a significant amount of infrastructure including: large pipes, a core trench, anti-seep collars, riser assembly with trash rack, and structural fill. Stormwater detention basins require a large



area to accommodate the pond, a set aside area for excavated sediments, and drainage components to convey the water to the pond. All of this limits site design capabilities. For example, a conventional approach to site design and stormwater management with non-clustered large lots gridded across the entire site and with a structural stormwater system culverted and piped by gravity to a basin, becomes very constraining. While a conservation design approach also limits site development, the limits are based on the natural conditions of the site and therefore can be more easily integrated into the overall site plan, in contrast to conventional, highly structured systems.<sup>116</sup>

Minimum disturbance includes minimizing the amount of impervious cover placed on the site, i.e. limiting development activities to the size and location necessary. There are a number of ways to minimize impervious cover on a new development including, for example:<sup>117</sup>

- ✓ Reduce and/or disconnect impervious areas;
- ✓ Reduce building setbacks, in turn reducing the length of driveways and entry walks;
- ✓ Reduce road widths;
- ✓ Limit sidewalks to one side of the street;
- ✓ Reduce lot size;
- ✓ Use cluster development/open space design to maximize open space;
- ✓ Use porous paving materials.

A 1992 study found that compaction associated with site construction reduces infiltration rates of soils to nearly zero, that of asphalt.

*DNREC and Brandywine Conservancy,  
"Conservation Design for Stormwater Management; A Design Approach to Reduce Stormwater Impacts from Land Development and Achieve Multiple Objectives Related to Land Use", September, 1997, p. 3-37*

It is important to avoid compacting soils that are intended to remain pervious. Clearing and grading can result in significant soil compaction, which reduces infiltration capacity and increases overland flow and runoff.<sup>118</sup> If soils do become compacted during construction, they need to be reclassified when calculations are done for stormwater runoff plans, taking the compaction into consideration. And efforts should be made to rehabilitate soils using techniques such as chisel plowing and reforestation.<sup>119</sup>

## 2. Conservation Design and Sensitive Areas

In addition to addressing traditional issues such as zoning, densities, setbacks, access, traffic patterns, etc., site planning should include identifying and mapping sensitive areas, soils and natural drainage features; avoiding or enhancing sensitive areas; and preserving or enhancing a site's natural hydrologic and pollutant filtering functions.<sup>120</sup> Sensitive areas include stream corridors, headwaters, wetlands, steep slopes, highly erodible soils, and karst bedrock.<sup>121</sup>

**Definition:** Karst geology -- regions "underlain by carbonate rock and typified by the presence of limestone caverns and sinkholes."

*2000 Maryland Stormwater Design Manual,  
MDE, Volume I, glossary, draft, 1999.*



**a. Conserving Headwaters by Design**

Headwaters are some of the most sensitive and important parts of a stream system. The headwaters are where a stream and/or river system begins. They are the small seeps and springs that come together to form the stream system. Headwaters are "locations of critical ecological functioning where exchange of energy from land to water occurs most directly and is most ecologically vital."<sup>122</sup> Base flow in headwater streams is naturally low, so small reductions in base flow volume can have a significant adverse impact. Similarly, stormwater runoff introduced into headwaters overwhelms the fragile flow, overwhelming the headwaters with degrading pollutants. And because stream base flow emerges from groundwater at about 55 degrees, headwater streams benefit from seasonal modulation of temperature -- cooler in summer and warmer in winter -- which is so critical to the aquatic biota in the stream.

**Definition:** Headwaters -- A watershed is drained by a network of stream channels. A stream that has no tributaries or contributing branches is defined as a "first order stream". When two first order streams come together, a second order stream is created. Headwater streams are defined as first and second order streams of a watershed.

*Rapid Watershed Planning Handbook, Center for Watershed Protection, October, 1998*

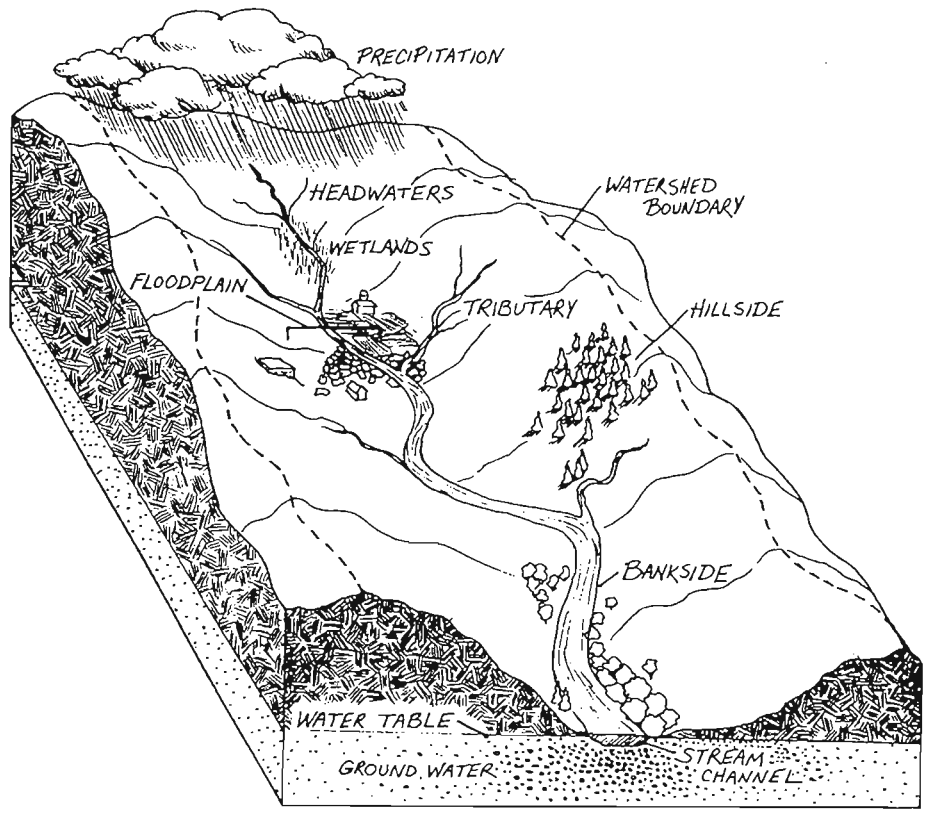

**"What happens in the local landscape is directly translated to headwater streams."**

*Rapid Watershed Planning Handbook, Center for Watershed Protection, October, 1998*

*Picture reprinted from Protecting Natural Wetlands: A Guide to Stormwater Best Management Practices, EPA, October, 1996*



Even though headwater streams are the smallest streams, they are crucial to watershed management because they dominate the landscape by their number and cumulative length. Headwaters comprise about 75% of the total stream and river mileage in the United States.<sup>123</sup>

Currently, conventional development practices locate streets and storm sewers in natural headwater valleys and swales,<sup>124</sup> which destroy these irreplaceable features. A minimum disturbance approach works to avoid this delicate network. In the ideal, development should be concentrated out of the first order stream sub-watersheds whenever possible.

### ***b. Conserving Streams by Design***

Forested stream buffers are capable of providing the maximum benefit for total watershed protection. Building forested riparian buffers into the minimum disturbance approach results in: (1) less impervious cover for the watershed (for headwater streams in this region, 5% of the contributing watershed can be preserved with a forested stream buffer

of 100 ft. wide on each side of the channel), (2) greater distance from the impervious area to the stream, extending time of concentration (see box, page 21), (3) less flooding and drainage problems because stormwater runoff is given more of an opportunity to infiltrate and structures are moved away from the stream and (4) needed space for streams to meander over time.<sup>125</sup> Therefore, a forested stream buffer program applied across the watershed (headwaters and non-headwaters), provides comprehensive environmental and community benefits and should be included in all development design projects.

#### ***Recommended Reading:***

*Michael J. Caduto, Pond and Brook, A Guide to Nature In Freshwater Environments, University Press of New England, 1985.*

### ***c. Conserving Wetlands by Design***

Wetlands are among the most productive ecosystems on earth.<sup>126</sup> Forty-two percent of the "total U.S. threatened and endangered species depend upon wetlands for survival."<sup>127</sup> Wetlands provide critical habitat for fish, wildlife and birds. Wetlands filter, remove, retain and/or utilize pollutants thereby maintaining and improving water quality in local streams.

Wetlands provide flood control, erosion control and groundwater recharge. Wetlands effectively absorb and hold floodwaters thereby protecting adjacent and downstream properties from flood damage.<sup>128</sup> At

*Delaware Riverkeeper Network  
1-800-8-DELAWARE*

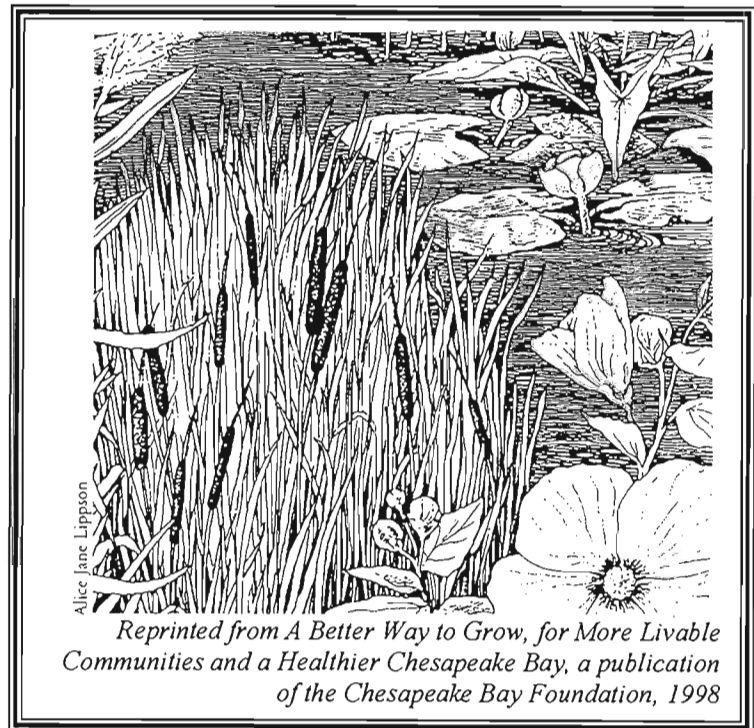

the same time, wetland vegetation helps to slow the speed of floodwaters -- this, in combination with the storage capabilities of wetlands, can both lower flood heights and reduce the erosive potential of floodwaters.<sup>129</sup> Wetlands can also desynchronize flood peak flows and velocities during small runoff events.<sup>130</sup> Wetlands within and upstream of urban areas are especially valuable for flood protection, since urban development increases the rate and volume of surface water runoff, thereby increasing the risk of flood damage.<sup>131</sup> Conversely, removal of wetlands can increase downstream flooding.<sup>132</sup>

Generally wetlands work as an integrated system with other wetlands in a watershed. When assessing the value, or lost value, of wetlands, it is important to recognize this critical interrelationship.<sup>133</sup>

Despite their tremendous value, more than half of America's original wetlands have been destroyed. "They have been drained and converted to farmland, filled for housing developments and industrial facilities, or simply used as receptacles for both household and hazardous waste."<sup>134</sup> And each year we continue to destroy nearly 500,000 acres of wetlands.<sup>135</sup>

Protecting and/or creating buffer areas around wetlands provides vegetation that can filter out sediments and other pollutants which might otherwise overwhelm a wetland system. Wetland buffers also help protect wetlands from being overwhelmed by surface runoff, provide room for a wetland to naturally migrate, help protect existing wetlands vegetation and habitats from encroachment, and can provide needed habitat to species dependent upon the wetland and adjacent uplands for their life cycle and survival.

Using conservation design practices, wetlands areas can be protected both from direct destruction as well as from gradual destruction such as occurs when development alters the hydrologic system and disrupts the water features that support and nurture a wetland's existence. Through clustering and careful site design, wetlands and wetland buffer zones can be maintained. In many cases, carefully designed and constructed wetlands can be used as stormwater management practices, building onto and reinforcing existing wetland ecosystems.

### **3. Reducing Overall Impacts -- and Costs -- by Design**

When the impacts of conventional site development design are compared with conservation design techniques at medium density residential, low-density residential, retail shopping center and commercial office park developments, conservation design has fewer negative environmental impacts, less runoff, smaller nutrient loads, and significantly lower infrastructure costs than conventional methods.<sup>136</sup>

The conservation design development approach can pay off financially for the developer. Because this approach reduces the volume of runoff, there is less stormwater runoff to manage -- this is reflected in runoff calculations and directly translates into a lesser degree of needed management and therefore a lesser cost for developers.<sup>137</sup> Preserving natural features such as wetlands and waterways enhances property values.<sup>138</sup> Conservation design strategies are

capable of reducing stormwater and subsurface nutrient export while substantially reducing infrastructure costs.<sup>139</sup>

Costs of different approaches to land development have been evaluated in several studies across the country which provide convincing evidence that the conservation design approach saves money as well as the environment. In work by DNREC and Brandywine Conservancy, several conventional developments proposed across a range of different Delaware conditions were redesigned using minimum disturbance conservation design. Each of these developments was also analyzed for costs. Although the cost analysis was not extremely detailed, results indicated a consistent and sometimes very large reduction in costs as conservation design practices were put to use. Reduction in site grading, less road building, elimination of culverts and inlets, minimizing piping and conveyance structures, elimination of costly detention basins with their elaborately engineered outlet structures -- all led to very convincing cost reductions. And this proved true even as the water quantity and water quality performance of the conservation design alternatives dramatically exceeded the conventional alternatives. In sum, the driving force behind the conservation design approach is environmental, but the economic implications can be surprisingly positive as well.

Cluster Development is a development design option that reduces the imprint of disturbance on a site by reducing lot size to the maximum and concentrating units into the least sensitive portions of a site. The cluster approach is beneficial because it reduces impervious cover, avoids sensitive site features, reserves site open space, and leaves protective buffers in place. Care should be taken to insure that cluster development does not create water and sewer capacity that encourages sprawl development and that either existing water and sewer infrastructure is used or an innovative on-site land-based system is employed. On-site water and sewer can be designed to recycle both stormwater and wastewater.

*Site Planning for Urban Stream Protection, Center for Watershed Protection, co-published by the Metropolitan Washington Council of Governments, December 1995 and DelawareRiverkeeper Network*

"The secret of successful real estate may be 'location, location, trees.' Recent research by the University of Guelph, Ontario, found that people were willing to pay up to 15% more for homes with trees (red oaks in this case). 'We figure \$10,000 (U.S. \$6,750) a tree,' says Nathan Perkins, professor of landscape architecture. 'If you're willing to wait 15 years for it to mature'."

*"Yes, It Does Grow on Trees",  
Garden Design, 2000*

"Treed lots have an average value of 5 to 7% more than lots without trees."

*Better Site Design: A Handbook for Changing Development Rules in Your Community by Center for Watershed Protection, 1992, p. 146*

In Bowie, MD, the Northridge housing development left mature trees in place and forests intact (approximately 40% of the development is forested), built the same number of units as a conventional design at a higher density, and installed BMP's in harmony with the landscape. The cost of developing the site was about the same as a conventional design and took no longer to build.<sup>140</sup>

In some cases, maximum efforts can be taken to preserve a site and conventional structural stormwater



controls are needed nonetheless. There is still an economic advantage for the developer if some natural features are allowed to remain and function as stormwater controls. Allowing some natural controls to remain intact will, at the very least, significantly reduce the size of the needed infrastructure, requiring less land area and ongoing maintenance, thereby reducing costs.<sup>141</sup> Additionally, the reduction in the volume of stormwater to be handled will lower the cost for stormwater facilities.<sup>142</sup>

#### **4. Conservation Design and Erosion Prevention**

While streams function to gather and move sediment, too much sediment in a stream is detrimental and considered legally and ecologically to be a pollutant. Excessive sediment loads block light and thereby inhibit the growth and reproduction of aquatic plants. Sediment smothers stream habitats and interferes with feeding and reproduction of fish and aquatic insects critical to the food chain.<sup>143</sup> Sediment can also interfere with fish gill function.

A typical site-grading plan destroys the natural systems of a site even before the development is built on the site. The land is graded and artificially re-molded. Soil is moved around and severely compacted, altering its texture and permeability. Streams and their headwaters are changed and the earth is stripped bare. The result is significant erosion onsite, causing serious sediment pollution of local waterways. During this construction phase, currently mandated soil conservation practices are simply inadequate. Sediment loadings from typical construction sites are 100 times greater per acre than those from farmland and approximately 2000 times greater per acre than undisturbed forest land.<sup>144</sup>

##### ***a. Conserving Soil During Construction***

Good management practices on the development site are essential, even when BMPs are being employed. The basic rule is that construction should be phased to minimize the time of disturbance – this is accomplished by limiting grading activities to areas where development is imminent.<sup>145</sup> Sometimes the problem of erosion and sedimentation lies in the inappropriate application of a soil conservation measure. A North Carolina study found that only half the trapping measures installed on construction sites were properly installed.<sup>146</sup> Poor maintenance, inspection and enforcement compound the use of ineffective and/or misapplied practices.

The municipality that invests in a regular inspection program for all construction sites will benefit by avoiding stream degradation and

downstream flooding. Unfortunately, agencies in charge of enforcement today are too often understaffed. The result is poor follow-up of construction activities by county and state agencies, leaving the municipality to pick up the pieces, at their expense. Watershed groups and alert residents are taking on the job of watchdogging construction sites and are sometimes the catalyst for desperately needed change.

"The mud washed from a typical construction site can damage 3 miles of stream waters with recovery taking up to a century."

*"How Much Development is Too Much for Streams, Rivers, Lakes, Tidal Waters and Wetlands?", Community and Environmental Defense Services, Maryland Line, MD*





Another benefit of the minimum disturbance and conservation design approach is the soil erosion and sedimentation that is avoided when traditional site grading is not used. In order to reduce soil erosion and sedimentation, the minimum disturbance approach to site design

"Minimizing clearing during the construction phase can reduce earth movement and erosion and sediment control costs by up to \$5,000 /acre."

*"Better Site Design: A Handbook for Changing Development Rules in Your Community", Center for Watershed Protection, August, 1998, p. 146 citing DE DNREC, 1997*

and stormwater management should be employed for every project and can be effectively combined with the other stormwater management approaches. Soil erosion prevention practices that protect existing soils and vegetation can reduce sediment pollution by 90%.<sup>147</sup>

Once a site is disturbed, soil erosion control measures and sediment trapping measures must be diligently incorporated and maintained on the construction site. Sediment trapping measures can keep as much as 50% to 75% of eroded soils out of nearby waterways but can never be as effective as the minimum disturbance approach.<sup>148</sup>

### ***b. Minimizing Site Disturbance: Preserving Nature's Design***

The steps to limit site disturbance include:

- ✓ Establish a limit of disturbance (LOD) around construction activities. The LOD should take into consideration reasonable construction techniques, the land use at issue, and the physical landscape such as slopes. Within a single site there may be more than one applicable LOD, e.g., one LOD for structures with another applicable to sidewalks and driveways.<sup>149</sup> "A suggested limit of disturbance around structures is 5 to 10 feet outward from the building pad."<sup>150</sup>
- ✓ Require the LOD to be clearly marked in the field.
- ✓ Integrate minimum disturbance requirements fully into the review process.
- ✓ Prescribe whether and where minimum disturbance is required or optional. For example, it may be required when there are serious concerns about water quality or when nearby water supply sources may be impacted (e.g., from a total watershed perspective, it may be appropriate to require a strict minimum disturbance approach in those areas tributary to lakes and reservoirs or in those areas with special protection waters designation [such as wild and scenic, exceptional value or high quality classifications], while recommending but not requiring this approach in other areas).

Site disturbance can also be minimized by building with the existing contours of the land such as aligning the building axis parallel to the existing contours of the site and staggering the floor level of buildings to adjust to existing natural grade changes.<sup>151</sup> The existing terrain is preserved and made part of the design.

Reducing site disturbance reduces its adverse impacts including soil compaction and the need for herbicide applications to eliminate weed growth on disturbed ground when final landscaping is installed. The retained natural area can also help capture and manage stormwater from impervious areas on the site.<sup>152</sup>



The reduction of site work that accompanies conservation design, including reduced rough and fine grading, reduced amount of clearing/grubbing, reduced amount of seeding/sodding, reduced amount of landscaping and reduced need for erosion and sediment controls, should more than balance out any cost increases associated with increased construction/development time that might be associated with this approach.<sup>153</sup> In addition, on a long-term basis, conservation design reduces site maintenance costs such as mowing, fertilization, and weed control once the development is completed. While it is certainly easier to include these techniques in planning for a new development, redevelopment projects can also be an opportunity to include them as well.

## **5. Fact Sheets**

The following fact sheets provide information on specific BMPs related to a minimum disturbance conservation design approach to development and will help in planning and evaluating which BMPs to use in specific situations. Design and construction of BMPs will require professional services.

Fact sheets are designed to be stand alone tools that can be copied and shared to help others understand the issues and to help develop successful management programs.





## Fact Sheet -- Stormwater Runoff, the Lost Resource Protecting and Restoring Native Plant Communities and Forests

Vegetation is a very effective means for managing stormwater runoff. Vegetation absorbs the energy of falling rain; it helps maintain the absorbency and porosity of the soil (and returns absorbency to highly compacted/dense areas) by maintaining soil aggregation and macropores. A natural vegetative community creates absorbent topsoil and a humus layer, the most absorbent soil layer. Vegetation itself takes up rainfall for its own use. Vegetation prevents erosion by holding soil in place. Vegetation slows the velocity of runoff, reducing its erosive force, allowing pollutants to settle out, and increasing the opportunity for infiltration. Vegetation removes different types of pollutants associated with stormwater runoff including sediment, phosphorus, nitrogen, and metals.<sup>1</sup> Consequently, loss of vegetation reduces the soil's ability to absorb rainfall, particularly when the soils have been compacted by development activities or repeated traffic. Traditional suburban lawns are far less effective at capturing and absorbing rainfall than areas vegetated with trees and shrubs. And grass cannot effectively rehabilitate soils that have lost their absorbent capacity due to compaction.

The organic litter layer found in forests "provides a physical barrier to sediments, maintains surface porosity, high infiltration rates, and increased populations of soil mycorrhizae (a mutualistic relation of plant roots and the mycelium of fungi which aids in decomposition of litter and translocation of nutrients from the soil into the root tissue, and provides a rich source of carbon essential for de-nitrification). The organic soils provide a reservoir for storage of nutrients to be later converted to wood biomass."<sup>2</sup> Preserving the natural forest allows this complex ecosystem to continue to function.

A forested buffer has ten to fourteen times the amount of runoff storage capacity than turf or grass.

*Site Planning for Urban Stream Protection, by the Center for Watershed Protection, co-published by the Metropolitan Washington Council of Governments, December 1995; and DNREC and Brandywine Conservancy, "Conservation Design for Stormwater Management: A Design Approach to Reduce Stormwater Impacts from Land Development and Achieve Multiple Objectives Related to Land Use", September, 1997, 2-23*

Undisturbed native grasslands and meadows are endangered ecosystems, especially in developing areas and heavily agricultural areas. Succession forests and mature forests are dwindling quickly throughout the Delaware Valley. These native plant communities provide

<sup>1</sup> Bruce K. Ferguson, Stormwater Infiltration, CRC Press, 1994, p. 38; DNREC and Brandywine Conservancy, Conservation Design for Stormwater Management: A Design Approach to Reduce Stormwater Impacts from Land Development and Achieve Multiple Objectives Related to Land Use, September, 1997, p. 3-6 & 3-7; Pennsylvania Handbook of Best Management Practices for Developing Areas, Prepared by CH2MHILL, Spring 1998, p. 1-25

<sup>2</sup> DNREC and Brandywine Conservancy, Conservation Design for Stormwater Management: A Design Approach to Reduce Stormwater Impacts from Land Development and Achieve Multiple Objectives Related to Land Use, September, 1997, p. 2-23



all the functions that the engineer tries to achieve in stormwater management and are also critical habitat. By keeping the native plant community intact, nature's system continues to work, and less mitigation is required when a site is disturbed.

The first rule should be to protect all established native plant communities found on a site because they have developed a stable ecosystem that functions as a living BMP. The second rule should be to re-establish native plant communities along waterways and other sensitive areas, and throughout the developed site as well, working them into the site design.

### **Why Native Plants?**

Native plants provide more benefits than non-native species. Native plants are adapted to the local climate, geologic and soil conditions. Only those plants that could thrive remain. Exotic species upset the dynamic equilibrium of native plant communities. Invasive species take over the niche meant for native plants by out-competing indigenous species, replacing them in the wild. Introduced species such as catbriar, loosestrife, and kudzu, can take over at an alarming rate.<sup>3</sup>

Native plants are economically preferable in landscaping and restoration because they are more adaptable to the locale and will perform better in the long run. They have "distinct genetic advantages over non-native species" because they have evolved to live in the region naturally. As a result, native plant species tend to be more durable. Root systems may be deeper, stronger. Native species need less to do more. When used in stormwater management systems, they have a higher rate of survival and need less replacement during the life of the project.<sup>4</sup>

### **Native Plant Communities Reduce Stormwater Runoff**

Using existing vegetation, particularly when combined with berming or containment, can help achieve stormwater volume control.<sup>5</sup> Preservation of tree cover directly translates into reduced stormwater runoff. It has been calculated that "40 percent tree cover could reduce stormwater runoff by 60 percent more than a neighborhood without trees."<sup>6</sup>

Examples of how vegetation has reduced stormwater runoff include:

- ✓ It has been "calculated that tree loss in [an] urban corridor resulted in a 19% increase in runoff from major storms, an estimated 540 million cubic feet of water. Replacing the lost stormwater retention capacity would cost \$1.08 billion."<sup>7</sup>
- ✓ In the Baltimore-Washington corridor the stormwater retention capacity of forest cover in 1973 was calculated to be worth \$5.7 billion.<sup>8</sup>

<sup>3</sup> 2000 Maryland Stormwater Design Manual, MDE, Volume I, glossary, draft, 1999

<sup>4</sup> 2000 Maryland Stormwater Design Manual, MDE, Volume I, glossary, draft, 1999

<sup>5</sup> DNREC and Brandywine Conservancy, Conservation Design for Stormwater Management: A Design Approach to Reduce Stormwater Impacts from Land Development and Achieve Multiple Objectives Related to Land Use, September, 1997, p. 3-48

<sup>6</sup> Gary Moll, "America's Urban Forests: Growing Concerns", American Forests, Autumn 1997

<sup>7</sup> Common Ground, Vol. 10 No. 4, May/June 1999

<sup>8</sup> Common Ground, Vol. 10 No. 4, May/June 1999



- ✓ In Atlanta, Georgia a 20% loss in tree cover in the metropolitan region produced a 4.4 billion cubic foot increase in stormwater runoff; and official estimates are that it would cost at least \$2 billion to build containment facilities capable of storing this excess water.<sup>9</sup>
- ✓ In Milwaukee, an existing tree canopy of 16% has been found to reduce stormwater flows by up to 22%, saving the City \$15.4 billion in "not having to build additional stormwater retention capacity."<sup>10</sup>
- ✓ In Texas, a tree canopy of 30% reduces stormwater runoff by 28% and saves Austin, TX \$122 million in stormwater control.<sup>11</sup>
- ✓ It has been determined that a 40% canopy tree cover in a metropolitan area with a population of around 2 million, could result in reduced stormwater management costs of more than \$2 billion a year.<sup>12</sup>

Sidewalk, driveway and rooftop runoff should take advantage of the pollution removal and infiltration benefits of vegetated areas at every opportunity. Runoff from these areas can be collected and conveyed to adjacent or even more distant native plant communities on or off site.<sup>13</sup>

### **Native Plant Communities Reduce Polluted Runoff and Improve Stream Health**

It is important to protect existing native plant communities along stream corridors and ponds. Riparian vegetative communities provide a number of benefits to both aquatic and terrestrial ecosystems -- they filter out and/or utilize nonpoint sources of pollution such as excess nutrients, sediments, metals and some pesticides; their root systems anchor soils, thereby preventing erosion; in-stream waters are cooled as a result of plant shading; and overland flow is slowed down as it passes over and around the vegetation, thus increasing soil absorption and groundwater recharge, and decreasing flood damage.<sup>14</sup> These functions will continue to benefit the waterway if established riparian systems are left intact and care is taken to protect them both in the design of the site and as a living BMP.

### **Native Plant Communities Reduce Costs**

Preserving and restoring native plant communities within a development project is cost effective. Costs associated with ground preparation, planting, watering, weeding and fertilizing landscaping for a new development are reduced if existing native plant communities

<sup>9</sup> Center for Watershed Protection, Better Site Design: A Handbook for Changing Development Rules in Your Community, August, 1998, p. 155 citing American Forest and US Water News in 1997; Gary Moll, "America's Urban Forests: Growing Concerns", American Forests, Autumn 1997

<sup>10</sup> Lynn McDonald, "Global Problems, Local Solutions, Measuring the Value of the Urban Forest", American Forests, Autumn 1996.

<sup>11</sup> Cheryl Kollin, "Designing with Nature and Showing the Benefits", Land Development, National Association of Home Builders, Winter, 1997

<sup>12</sup> Gary Moll, "America's Urban Forests: Growing Concerns", American Forests, Autumn 1997

<sup>13</sup> DNREC and Brandywine Conservancy, Conservation Design for Stormwater Management: A Design Approach to Reduce Stormwater Impacts from Land Development and Achieve Multiple Objectives Related to Land Use, September, 1997, p. 3-49

<sup>14</sup> Bruce K. Ferguson, Stormwater Infiltration, CRC Press, 1994, p. 38; DNREC and Brandywine Conservancy, Conservation Design for Stormwater Management: A Design Approach to Reduce Stormwater Impacts from Land Development and Achieve Multiple Objectives Related to Land Use, September, 1997, p. 3-6 & 3-7; Pennsylvania Handbook of Best Management Practices for Developing Areas, Prepared by CH2MHILL, Spring 1998, p. 1-25



are left intact. Stormwater management costs are also reduced because less disturbed area and less impervious surfaces are created and the existing plant communities can be incorporated into the site's stormwater management system. Native plant communities and natural forested areas reduce air, water and noise pollution as well.

### **Native Plant Communities Increase Development Marketability**

- ✓ In a survey conducted by the National Association of Home Builders, 43% of home buyers paid a premium of up to \$3,000, 30% paid premiums of \$3,000 to \$5,000, and 27% paid premiums of over \$5,000 for homes with trees.<sup>15</sup>
- ✓ "Two regional economic surveys documented that conserving forests on residential and commercial sites enhanced property values by an average of 6 to 15% and increased the rate at which units were sold or leased."<sup>16</sup>
- ✓ "It has been conservatively estimated that over \$1.5 billion per year is generated in tax revenue for communities in the U.S. due to the value of privately-owned trees on residential property."<sup>17</sup>

"The secret of successful real estate may be 'location, location, trees.' Recent research by the University of Guelph, Ontario, found that people were willing to pay up to 15% more for homes with trees (red oaks in this case). 'We figure \$10,000 (U.S. \$6,750) a tree,' says Nathan Perkins, professor of landscape architecture. 'If you're willing to wait 15 years for it to mature'."

*"Yes, It Does Grow on Trees",  
Garden Design, 2000*

- ✓ "The resale value of a home may be enhanced by as much as 15% with landscaping."<sup>18</sup>

### **Management and Maintenance**

When revegetating an area, it is important to recognize that in the early years stormwater infiltration and pollutant removal will not be as effective as a mature natural area would provide. To recognize this reality in the stormwater calculation process, hydrologic soil group calculations should be reduced by a grade level (A,B,C,D) and revegetated areas should be characterized as in "poor condition" for purposes of stormwater calculations via the soil cover complex method. As revegetated areas become more established their stormwater management performance will improve, enhancing their water quality and quantity performance, thereby

<sup>15</sup> Cheryl Kollin, "Designing with Nature and Showing the Benefits", Land Development, National Association of Home Builders, Winter, 1997

<sup>16</sup> Center for Watershed Protection, Better Site Design: A Handbook for Changing Development Rules in Your Community, August, 1998 Citing two studies by Morales and Weyerhauser

<sup>17</sup> Center for Watershed Protection, Better Site Design: A Handbook for Changing Development Rules in Your Community, August, 1998 Citing USDA and the National Arbor Day Foundation

<sup>18</sup> Center for Watershed Protection, Better Site Design: A Handbook for Changing Development Rules in Your Community, August, 1998 Citing the American Nursery and Landscape Association.



providing more benefits to the watershed as time goes by.<sup>19</sup> As trees mature, they become more effective as a stormwater management mechanism<sup>20</sup> -- a living BMP.

For the first five years, to ensure good survival of plants, a management program based on watering, weeding and monitoring should be carried out. Management needs will decrease as plants mature. At the same time, infiltration capacity will increase.<sup>21</sup> Chemical fertilizers, pesticides, and herbicides should be avoided and organic management practices employed.

Often non-native species are used in landscaping a development for their ornamental value. Native species of plants, shrubs, and trees provide equal, if not greater, aesthetic value when well chosen for the conditions of the site. Because many natives are not well known, they are not widely used. But native nurseries are becoming more prevalent and this growing industry has expanded in recent years in the Delaware Valley. Many of these nurseries offer the bonus of knowledgeable advice and guidance on the use of native plants. By utilizing native species in stormwater management systems, they can become restored to the region, protecting the plant diversity and natural heritage of the Delaware River watershed.

Appendix A includes an expanded but by no means complete list of plants native to the region as well as some local suppliers.

<sup>19</sup> DNREC and Brandywine Conservancy, Conservation Design for Stormwater Management: A Design Approach to Reduce Stormwater Impacts from Land Development and Achieve Multiple Objectives Related to Land Use, September, 1997, p. 3-49

<sup>20</sup> DNREC and Brandywine Conservancy, Conservation Design for Stormwater Management: A Design Approach to Reduce Stormwater Impacts from Land Development and Achieve Multiple Objectives Related to Land Use, September, 1997, p. 3-23

<sup>21</sup> DNREC and Brandywine Conservancy, Conservation Design for Stormwater Management: A Design Approach to Reduce Stormwater Impacts from Land Development and Achieve Multiple Objectives Related to Land Use, September, 1997, p. 3-50





## Fact Sheet -- Stormwater Runoff, the Lost Resource Preserving and Restoring Natural Soils

Best management practices (BMPs) that infiltrate stormwater rely on the soil in order to work. Nonstructural BMPs, in particular, rely on specific properties of the natural soil mantle in order to effectively process stormwater. When soils with the proper characteristics are not present to accomplish this goal, soil amendments can be added but this involves cost and disruption. It is best to preserve the on-site soils intact with vegetation and to design the planned stormwater management systems for a development to fit within these natural site-specific parameters.

One of the most important characteristics of soil for stormwater management is soil permeability (percolation rate is also used to describe permeability). Permeability, very much related to soil texture and particle size, is typically measured in inches per hour with a minimum permeability rating of 0.5 inches per hour often used as a threshold for reasonable successful best management practices. Permeability is used as a major input into the rating of soils by Hydrologic Soil Groups, A (best) through D (worst). C soils may have borderline permeability acceptability, although undisturbed heavy clayey soils with woodland or meadow cover can infiltrate far more precipitation than their rated permeabilities would indicate.

Soils have other important characteristics that relate to stormwater and water quality. The ability of soil to remove nonpoint source pollutants loaded into stormwater is enabled by a complex array of natural functions: physical, chemical, and biological. Physically, soil itself filters a variety of different pollutants, such as suspended solids, from stormwater. Chemically, the ion exchange functions of natural soils will attract and bond metal and other ions. Biologically, microorganisms, many of which have now been adapted for hazardous waste treatment technologies, further reduce nonpoint source pollutant loads. In sum, the natural soil mantle, if understood and protected, is a wonderful stormwater management opportunity which should be integrated carefully into stormwater management planning.

### **Traditional Site Development Destroys Natural Soils**

When a site is developed conventionally, extensive grading usually dramatically remolds the existing landscape. Native soils are often scraped off a site and sometimes they are even sold, leaving highly erodible subsoils exposed to the elements, destroying the natural soil mantle virtually forever. What took nature tens of thousands of years to create is destroyed in a matter of hours by heavy equipment. And even in areas that are not graded, soils can be destroyed by compaction. The precious soil mantle is actually a rare and wonderful resource, a fragile thin lens of life upon which human life is so dependent. A cubic foot of soil is an awesome community of thousands, even millions of life forms -- the very antithesis of the standard notion that it is just dirt in need of disposal or sale offsite.

Travel over soil with heavy equipment or repeated travel with lighter equipment compacts the soil, reducing the pores in the soil and reducing the soil's ability to, and capacity for, absorbing and infiltrating rainfall. As a result of repeated equipment travel over the land the

upper layers of soil can be compacted to nearly the density of concrete,<sup>1</sup> thereby preventing absorption into the deeper layers of soil.

Studies indicate that compaction of soils on a site that is being disturbed takes place in a very short period of time. Generally, during development activities, nearly all of the compaction occurs during the first trip over the ground, with most of the compaction taking place near the surface. One study found that even one pass by an empty pickup truck can reduce the void ratio from 1.23 to 1.00 and that slightly more truck travel brings the void ratio down to .71.<sup>2</sup> Areas mowed regularly have been found to suffer from soil compaction with a reduction in the void ratio from 0.79-0.81 to 0.12-0.13. Even excessive human foot traffic can compact soils, reducing the pores in the soil.<sup>3</sup>

Maintaining the vegetation on the land is the best method of protecting soils from compaction. The vegetation allows the creation of topsoil and humus (which is the most absorbent layer on the ground) providing pathways for the water to enter the ground. This maintains the natural absorbency of the soil sponge.

### **Damaged Soils Can Be Renovated**

If land has been disturbed and compacted or converted to typical turf, significantly reducing the permeability of what are generally considered to be soils with good permeability, revegetation with native trees or shrubs is an effective restoration technique.

Vegetation (other than turf grass) significantly enhances the infiltration capabilities of the underlying soil.<sup>4</sup> By allowing vegetation to become established with a well-developed root zone, poor soil permeability can be greatly improved. Whether damaged from construction practices or of a class of soil that doesn't percolate well naturally, vegetation, such as trees and shrubs, allows the land to capture and infiltrate stormwater runoff quite effectively.<sup>5</sup>

Woodlands renovate compacted and disturbed soils most effectively. As the humus layer builds in a succession forest, the soils change, becoming better able to support more mature vegetation and more able to infiltrate rain. **"A mature forest can absorb as much as 14 times more water than an equivalent area of grass."**<sup>6</sup>

---

<sup>1</sup> Chris Smith, Soil Scientist, "Soil Health Restoration," April 1998

<sup>2</sup> 1993 soils engineering evaluation conducted by Earth Engineering Incorporated.

<sup>3</sup> Chris Smith, Soil Scientist, "Soil Health Restoration," April 1998

<sup>4</sup> DNREC and Brandywine Conservancy, Conservation Design for Stormwater Management: A Design Approach to Reduce Stormwater Impacts from Land Development and Achieve Multiple Objectives Related to Land Use, September, 1997, p. 3-38

<sup>5</sup> DNREC and Brandywine Conservancy, Conservation Design for Stormwater Management: A Design Approach to Reduce Stormwater Impacts from Land Development and Achieve Multiple Objectives Related to Land Use, September, 1997, p. 3-5

<sup>6</sup> DNREC and Brandywine Conservancy, Conservation Design for Stormwater Management: A Design Approach to Reduce Stormwater Impacts from Land Development and Achieve Multiple Objectives Related to Land Use, September, 1997, p. 2-23



## Fact Sheet -- Stormwater Runoff, the Lost Resource Riparian Buffers

In its natural state, most of the Delaware River watershed would be forested,<sup>7</sup> or covered with other native vegetation. In this natural state, the land would give rise to free-flowing, unpolluted streams. Vegetation throughout the watershed is critical but many of the most important functions are provided by the vegetation adjacent to waterways in the riparian zone. The vegetation that lines a stream is known as a riparian buffer and should be left intact whenever possible. Riparian buffers are naturally vegetated areas adjacent to waterways, including streams, ponds, estuaries and wetlands. Riparian buffers and streamside forests are complex ecosystems vital to the protection of our streams and stream life.<sup>8</sup>

Forested riparian buffers provide a balanced, integrated, adaptive community of riparian and aquatic organisms which have the capacity for stability and self-repair.<sup>9</sup> Riparian buffers provide food, cover and habitat for wildlife and aquatic organisms,<sup>10</sup> and cool the stream with shade. Riparian buffers increase infiltration, groundwater recharge and surface water recharge; attenuate the rate of runoff to streams; reduce flood peaks; reduce streambank erosion; improve and increase aquatic and forested habitat; reduce sedimentation caused by overland flow; remove nonpoint sources of pollution such as nitrogen, phosphates and some pesticides from runoff from agricultural, suburban or urban land uses.<sup>11</sup>

Before European settlement, Delaware was almost all forested, now only about 30% is forested. In the State of Delaware it was found that the physical habitat of 90% of the streams were disturbed as the result of channelization or urban development. "In the majority of cases the impact was caused by a lack of native vegetation along the stream channel."

*DNREC and Brandywine Conservancy,  
"Conservation Design for Stormwater  
Management; A Design Approach to Reduce  
Stormwater Impacts from Land Development and  
Achieve Multiple Objectives Related to Land  
Use", September, 1997, p. 2-19*

<sup>7</sup> Horner and Harper, "Conservation Design Strategies for Stormwater Management: Integrating Native Plants at the Rivercrest Golf Community, Upper Providence, Montgomery County, PA", 1998 *Southeastern Pennsylvania Stormwater Management Symposium, Villanova University*

<sup>8</sup> David Welsch, Forest Resources Management, USDA Forest Service, "Riparian Forest Buffers: Function and Design for Protection and Enhancement of Water Resources", NA-PR-07-91

<sup>9</sup> David Welsch, Forest Resources Management, USDA Forest Service, "Riparian Forest Buffers: Function and Design for Protection and Enhancement of Water Resources", NA-PR-07-91

<sup>10</sup> David Welsch, Forest Resources Management, USDA Forest Service, "Riparian Forest Buffers: Function and Design for Protection and Enhancement of Water Resources", NA-PR-07-91

<sup>11</sup> Pennsylvania Handbook of Best Management Practices for Developing Areas, Prepared by CH2MHILL, Spring 1998; David Welsch, Forest Resources Management, USDA Forest Service, "Riparian Forest Buffers: Function and Design for Protection and Enhancement of Water Resources", NA-PR-07-91; Fischer, Martin and Fischenich, "Improving Riparian Buffer Strips and Corridors for Water Quality and Wildlife," *International Conference on Riparian Ecology and Management in Multi-Land Use Watersheds*, Conference Proceedings, American Water Resources Association, August 28-31, 2000



## **Vegetated Riparian Buffers Provide Water Quality, Water Quantity, and Habitat Benefits**

Land development, agricultural, and open space projects should all endeavor to preserve and protect all existing riparian buffers and integrate riparian buffers into the entire site plan, and re-vegetate riparian buffers where they have been disturbed and/or removed.

Native plants, specific to the locale, should always be used in vegetated buffers. Native plants are best adapted to our area, rainfall patterns, and soil conditions. They have evolved and developed relationships with wildlife and other plant species. As a result, native plants provide optimal performance and will require little care or maintenance. Exotic species should be avoided as they are often invasive, supplanting native vegetation, and are subject to pests and disease.

Natural riparian ecosystems provide a number of benefits to stream health, runoff volume, aquatic and terrestrial ecosystems and water quality:

✓ Sediment and particulates are trapped by the structure of the forest floor and other naturally vegetated communities. Riparian buffer vegetation and organic litter slow the flow of runoff, allowing a greater opportunity for sediment and particulates to settle out before entering a stream or other waterway.

✓ Plants, via their root systems, take up pollutants, especially nitrogen and phosphorus that are essential for plant growth.<sup>12</sup> About 80% of phosphorus in runoff is removed by forested buffers; about 80% of nitrogen is transformed to gases by the anaerobic conditions in leaf litter and surface soil layers, removing it from runoff; pesticides are formed into gases by the anaerobic conditions in leaf litter and surface soil layers or are taken up as nutrients by plants and trees, removing them from runoff; pesticides are also transformed and biodegraded.<sup>13</sup>

✓ Vegetated buffers, especially woody shrubs and trees, slow down surface water runoff, soak up water, and encourage stormwater infiltration. Buffers thereby reduce in-stream channel velocity and volume during storm events.<sup>14</sup>

Riparian buffers can provide:<sup>1</sup>

- ✓ Increased runoff infiltration;
- ✓ Pollution removal including sediment, particulates, nutrients and pesticides;
- ✓ Control of stream temperature;
- ✓ Stream shading;
- ✓ Habitat and wildlife migration paths;
- ✓ Help maintain channel morphology and stability;
- ✓ Contribute to the food web.

*DNREC and Brandywine Conservancy,  
"Conservation Design for Stormwater  
Management; A Design Approach to  
Reduce Stormwater Impacts from Land  
Development and Achieve Multiple  
Objectives Related to Land Use",*

<sup>12</sup> DNREC and Brandywine Conservancy, Conservation Design for Stormwater Management: A Design Approach to Reduce Stormwater Impacts from Land Development and Achieve Multiple Objectives Related to Land Use, September, 1997, p. 1-25

<sup>13</sup> David Welsch, Forest Resources Management, USDA Forest Service, "Riparian Forest Buffers: Function and Design for Protection and Enhancement of Water Resources", NA-PR-07-91

<sup>14</sup> J. Toby Tourbier, "Open Space Through Stormwater Management, Helping to Structure Growth on the Urban Fringe"



✓ Root systems anchor soils reducing erosion. The deep root systems of trees and shrubs are critical for stabilizing streambanks,<sup>15</sup> holding soil in place -- a job turf grass cannot do effectively.<sup>16</sup>

✓ Vegetated streambanks, particularly trees and shrubs, help cool water temperature. This is important for fish. Denuded waterways typically suffer from increased instream water temperatures reducing the oxygen carrying capacity of the waterway.<sup>17</sup> Also, as water temperature increases above 60 degrees F, phosphorus (a nutrient) attached to sediment, is more readily released from its sediment hosts and dispersed into the stream as a pollutant.<sup>18</sup>

✓ Riparian buffers enhance property market values. For example, "Pennypack Park in Philadelphia is credited with a 38% increase in the value of a nearby property."<sup>19</sup>

✓ Vegetated streambanks, low lying branches, root systems, submerged logs and other detritus provide critical wildlife habitat, benefiting terrestrial, aquatic and reptile/herptile species.<sup>20</sup> The rich habitat adds to the organic food base and increases biological diversity and productivity of stream communities. In small upland streams as much as 75% of the organic food base may be supplied by dissolved organic compounds or detritus such as fruit,

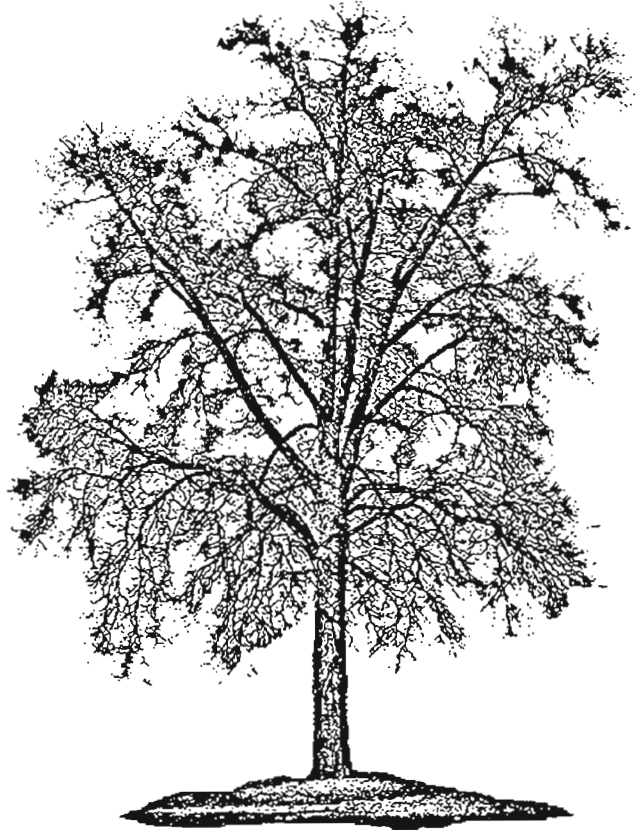

<sup>15</sup> DNREC and Brandywine Conservancy, Conservation Design for Stormwater Management: A Design Approach to Reduce Stormwater Impacts from Land Development and Achieve Multiple Objectives Related to Land Use, September, 1997, p. 2-18

<sup>16</sup> DNREC and Brandywine Conservancy, Conservation Design for Stormwater Management: A Design Approach to Reduce Stormwater Impacts from Land Development and Achieve Multiple Objectives Related to Land Use, September, 1997

<sup>17</sup> J. Toby Tourbier, "Open Space Through Stormwater Management, Helping to Structure Growth on the Urban Fringe"

<sup>18</sup> DNREC and Brandywine Conservancy, Conservation Design for Stormwater Management: A Design Approach to Reduce Stormwater Impacts from Land Development and Achieve Multiple Objectives Related to Land Use, September, 1997

<sup>19</sup> Center for Watershed Protection, Better Site Design: A Handbook for Changing Development Rules in Your Community, August, 1998, p. 134

<sup>20</sup> DNREC and Brandywine Conservancy, Conservation Design for Stormwater Management: A Design Approach to Reduce Stormwater Impacts from Land Development and Achieve Multiple Objectives Related to Land Use, September, 1997

limbs, leaves, and insects that fall from the forest canopy.<sup>21</sup> Benthic organisms feed on the detritus, forming the basis of the food chain.<sup>22</sup>

✓ Forested corridors connect isolated blocks of habitat allowing wildlife to migrate from one community to another.<sup>23</sup>

✓ Riparian corridors provide shelter for insects that are beneficial in the control of agricultural pests<sup>24</sup> and provide a natural integrated pest management system for the local environment.

### **Buffer Width Should Vary with Stream Needs and Protection Goals**

The recommended standard for riparian forest buffers is called the 3-zone buffer.<sup>25</sup> This is the minimum buffer that is needed to accomplish the buffer's water quality, quantity and habitat functions:

- **Zone one** is the undisturbed forest and is directly adjacent to the stream. It should be at least 15 feet wide. Vegetation is generally trees and woody shrubs. Special functions are to provide shade, nutrients for aquatic organisms, and streambank stabilization.
- **Zone two** is generally at least 60 feet wide. Zone two's function is "to provide necessary contact time and material for buffering and filtering processes." Distributed runoff as sheet flow should pass through this zone, both surface and subsurface, in order to achieve water quality purification functions. Because concentrated runoff through this zone cannot be mitigated, techniques to disperse flow into sheet flow or subsurface flow should be employed. Vegetation is typically trees and shrubs.
- **Zone three** is generally a minimum of 20 feet wide, and is intended to filter sediment, take up nutrients and convert concentrated flow to sheet flow. It can be vegetated with grazed or ungrazed grasses.

---

<sup>21</sup> David Welsch, Forest Resources Management, USDA Forest Service, "Riparian Forest Buffers: Function and Design for Protection and Enhancement of Water Resources", NA-PR-07-91

<sup>22</sup> David Welsch, Forest Resources Management, USDA Forest Service, "Riparian Forest Buffers: Function and Design for Protection and Enhancement of Water Resources", NA-PR-07-91; Pennsylvania Handbook of Best Management Practices for Developing Areas, Prepared by CH2MHILL, Spring 1998

<sup>23</sup> DNREC and Brandywine Conservancy, Conservation Design for Stormwater Management: A Design Approach to Reduce Stormwater Impacts from Land Development and Achieve Multiple Objectives Related to Land Use, September, 1997

<sup>24</sup> DNREC and Brandywine Conservancy, Conservation Design for Stormwater Management: A Design Approach to Reduce Stormwater Impacts from Land Development and Achieve Multiple Objectives Related to Land Use, September, 1997

<sup>25</sup> Pennsylvania Handbook of Best Management Practices for Developing Areas, Prepared by CH2MHILL, Spring 1998



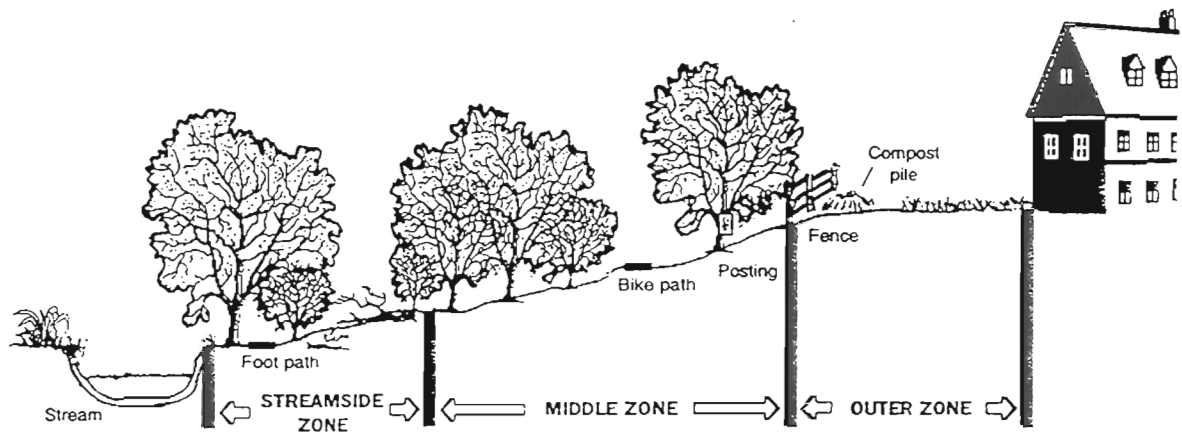

CHARACTERISTICS	STREAMSIDE ZONE	MIDDLE ZONE	OUTER ZONE
FUNCTION	Protect the physical integrity of the stream ecosystem	Provide distance between upland development and streamside zone	Prevent encroachment and filter backyard runoff
WIDTH	Min. 25 feet, plus wetlands and critical habitats	50 to 100 feet, depending on stream order, slope, and 100 year floodplain	25 foot minimum setback to structures
VEGETATIVE TARGET	Undisturbed mature forest. Reforest if grass	Managed forest, some clearing allowable	Forest encouraged, but usually turfgrass
ALLOWABLE USES	<b>Very Restricted</b> e.g., flood control, utility right of ways, footpaths, etc.	<b>Restricted</b> e.g., some recreational uses, some stormwater BMPs, bike paths, tree removal by permit	<b>Unrestricted</b> e.g., residential uses including lawn, garden, compost, yard wastes, most stormwater BMPs

### The three zone stream buffer system

*Reprinted from Site Planning for Urban Stream Protection, by the Center for Watershed Protection, co-published by the Metropolitan Washington Council of Governments, December 1995*

In a riparian buffer system, combining a grass strip on the outer zone, forested buffer in the middle, and vegetated streamside zone can achieve the following removal rates:<sup>154</sup>

- ✓ sediment 75%
- ✓ total nitrogen 40%
- ✓ total phosphorous 50%
- ✓ trace metals 60 to 70%
- ✓ hydrocarbons 75%

Buffer widths should vary based on needs. But, in general, riparian buffers should be made as wide as possible. The recommended buffer width will vary depending on the goals being strived for and surrounding land use. For example, a wider buffer may be required for areas where there is a higher intensity of land use such as urban areas, as compared to areas with a low-intensity land-use.<sup>26</sup> Also, chemically treated land such as typical golf courses,

<sup>26</sup> May and Horner, "The Cumulative Impacts of Watershed Urbanization on Stream Riparian Ecosystems", *International Conference on Riparian Ecology and Management in Multi-Land Use Watersheds*, Conference Proceedings, American Water Resources Association, August 28-31, 2000.





silviculture, and agriculture that do not employ organic management practices may require wider buffers. Buffer width needs will also vary with the characteristics of the stream being protected -- for example streams used by salmonids for spawning may require a larger buffer than a stream used only as a salmonid migration corridor.<sup>27</sup> Equally as important as buffer width is the characteristics of the vegetation including species diversity, vegetation type, physical condition and maturity.

**Criteria to help determine recommended buffer width for a particular stream:**

- (1) the resources to be protected;
- (2) "site, watershed and buffer characteristics;"
- (3) "the intensity of adjacent land use;"
- (4) "the specific buffer functions desired."

Todd, "Making Decisions About Riparian Buffer Width," *International Conference on Riparian Ecology and Management in Multi-Land Use Watersheds*, Conference Proceedings, American Water Resources Association, August 28-31, 2000.

A minimum of approximately 100 feet is recommended to ensure full opportunity for infiltration, water quality benefits, temperature moderation, streambank stabilization, contributions to the aquatic food web and is the minimum needed to begin to provide wildlife habitat.<sup>28</sup> However, as little as 25 feet can begin to restore hydrologic function to a stream and 35 feet is the minimum considered necessary for water quality benefits and creating forest structure and riparian habitat.<sup>29</sup> However, there is scientific research to support the position that a buffer of less than 35 feet "cannot sustain long-term protection of aquatic resources."<sup>30</sup> In the other direction, a 325-foot buffer is considered necessary for wildlife habitat, with reptiles and amphibians needing even more.<sup>31</sup>

Ideally, the buffer width can fluctuate with the needs of the stream and adjacent land use as it is implemented through the stream corridor. While a fixed buffer width (a uniform width) requirement is easier to enforce, it may fail to provide for varying ecological functions along a stream and in a watershed. A variable width buffer which addresses site specific conditions

<sup>27</sup> May and Horner, "The Cumulative Impacts of Watershed Urbanization on Stream Riparian Ecosystems", *International Conference on Riparian Ecology and Management in Multi-Land Use Watersheds*, Conference Proceedings, American Water Resources Association, August 28-31, 2000.

<sup>28</sup> Todd, "Making Decisions About Riparian Buffer Width," *International Conference on Riparian Ecology and Management in Multi-Land Use Watersheds*, Conference Proceedings, American Water Resources Association, August 28-31, 2000; Fischer, Martin and Fischenich, "Improving Riparian Buffer Strips and Corridors for Water Quality and Wildlife," *International Conference on Riparian Ecology and Management in Multi-Land Use Watersheds*, Conference Proceedings, American Water Resources Association, August 28-31, 2000

<sup>29</sup> Pennsylvania Handbook of Best Management Practices for Developing Areas, Prepared by CH2MHILL, Spring 1998; Fischer, Martin and Fischenich, "Improving Riparian Buffer Strips and Corridors for Water Quality and Wildlife," *International Conference on Riparian Ecology and Management in Multi-Land Use Watersheds*, Conference Proceedings, American Water Resources Association, August 28-31, 2000

<sup>30</sup> Todd, "Making Decisions About Riparian Buffer Width," *International Conference on Riparian Ecology and Management in Multi-Land Use Watersheds*, Conference Proceedings, American Water Resources Association, August 28-31, 2000

<sup>31</sup> Todd, "Making Decisions About Riparian Buffer Width," *International Conference on Riparian Ecology and Management in Multi-Land Use Watersheds*, Conference Proceedings, American Water Resources Association, August 28-31, 2000; Fischer, Martin and Fischenich, "Improving Riparian Buffer Strips and Corridors for Water Quality and Wildlife," *International Conference on Riparian Ecology and Management in Multi-Land Use Watersheds*, Conference Proceedings, American Water Resources Association, August 28-31, 2000



and needs -- such as vegetation, topography, hydrology, fish and wildlife -- is more beneficial and environmentally productive.<sup>32</sup>

One advantage of the forested buffer is that it can work on steep slopes, where other BMPs may be difficult to install. If a site does not have room for a wide buffer then sheet flow into the edge of the riparian forest buffer should be encouraged for water quality benefits.

### Design considerations

✓ Buffers should be made as wide as possible to accommodate site specific needs along a stream corridor.

✓ The riparian buffer closest to the stream should be planted with species that:<sup>33</sup>

- ✿ Tolerate saturated or partly saturated soils;
- ✿ Can be inundated for short periods after storms;
- ✿ Withstand occasional drought during dry weather;
- ✿ Stabilize the streambank from erosion;
- ✿ Provide shade and cooling to adjacent waterways;
- ✿ Enhance pollution uptake;
- ✿ Are very low maintenance since access can be difficult;
- ✿ Provide food and cover for wildlife;
- ✿ Provide habitat inhospitable to resident waterfowl;
- ✿ Are native species.

✓ The floodplain area upland from the riparian buffer should be planted with species that:<sup>34</sup>

- ✿ Tolerate occasional short-term inundation during storms;
- ✿ Tolerate moist soils and drought conditions;
- ✿ Stabilize the floodplain;
- ✿ Are low maintenance;
- ✿ Provide food and cover for wildlife;
- ✿ Provide structure for under-plantings;
- ✿ Provide shade and cooling.

"Trees release stored moisture to the atmosphere through transpiration while soluble nutrients are used for growth."

DNREC and Brandywine Conservancy, "Conservation Design for Stormwater Management; A Design Approach to Reduce Stormwater Impacts from Land Development and Achieve Multiple Objectives Related to Land Use", September, 1997

### Municipal Regulations

Municipalities have the option of incorporating riparian buffer protection programs in both their zoning ordinances as well as their subdivision/land development regulations. A variety of different models are available from different agencies. An increasing number of municipalities have adopted riparian buffer regulations, and these regulations have withstood legal challenge. Though the specific standards are based on scientific results, aspects of the regulations can be modified to fit specific municipal contexts (i.e.: wild and scenic, high quality or exceptional

<sup>32</sup> Fischer, Martin and Fischenich, "Improving Riparian Buffer Strips and Corridors for Water Quality and Wildlife," *International Conference on Riparian Ecology and Management in Multi-Land Use Watersheds*, Conference Proceedings, American Water Resources Association, August 28-31, 2000

<sup>33</sup> 2000 Maryland Stormwater Design Manual, MDE, Volume I, glossary, draft, 1999, p. A7

<sup>34</sup> 2000 Maryland Stormwater Design Manual, MDE, Volume I, glossary, draft, 1999, p. A8



value stream designation or type of upland land use could influence buffer width and management).

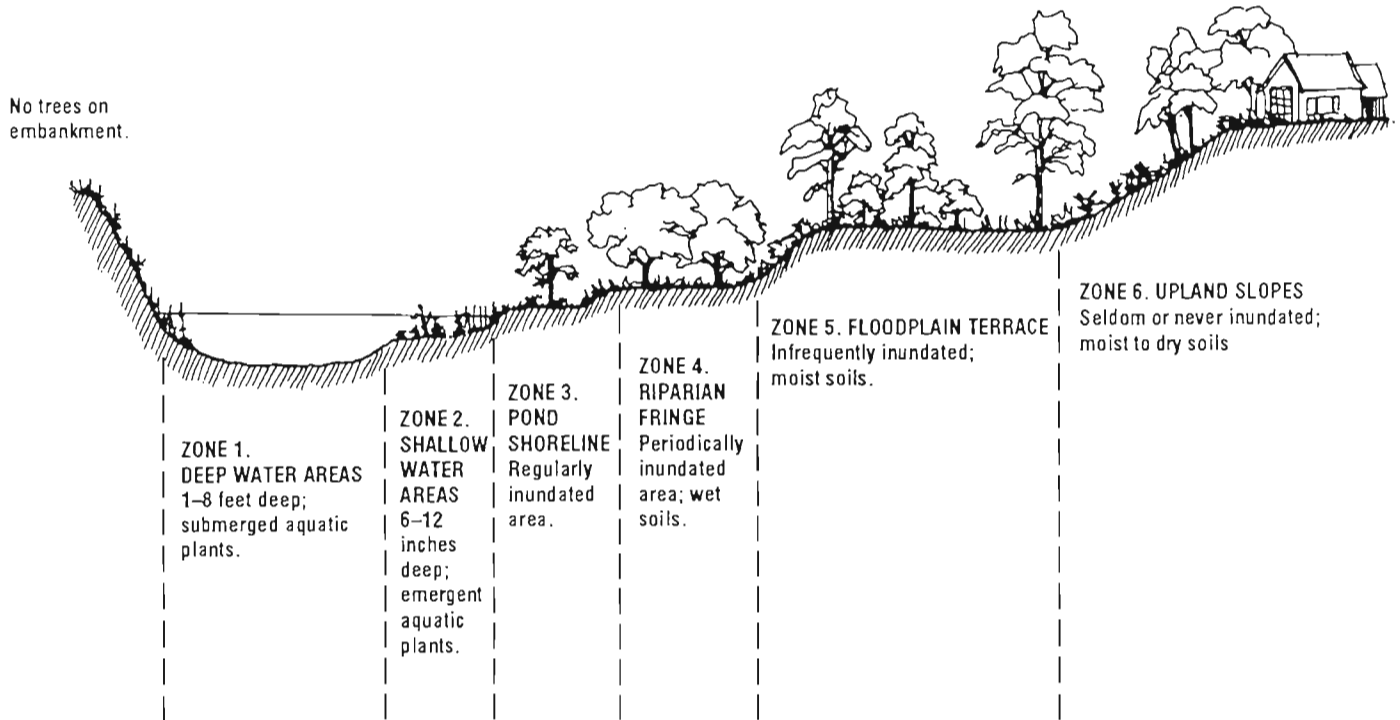

### Riparian Landscaping Zones

*Providing Wetlands for Wildlife While Controlling Stormwater, Penn State Cooperative Extension, Extension Circular 384.*

### Maintenance

While a riparian buffer is being established, it is important to inspect it regularly. Weeding is important and watering and replacement of vegetation may be necessary. In addition to careful observations during the first year or so, inspections should also be done after large storms and heavy runoff to remove unnatural debris, to check for damage to vegetation, and to inspect for erosion and for channelized flows through the buffer. Once the buffer is established routine maintenance is minimal. This includes litter removal, spot vegetation repair, removal of sediment buildup (over 6") and periodic fertilization (only natural fertilizers should be used). Annual inspections should be done to look for encroachment by vehicles or foot traffic, gully erosion or any evidence of concentrated flows through the area, especially if surrounding conditions have changed.<sup>35</sup>

<sup>35</sup> Protecting Natural Wetlands: A Guide to Stormwater Best Management Practices, USEPA, October, 1996



## Fact Sheet -- Stormwater Runoff, the Lost Resource Reducing Impervious Surfaces

When designing new developments, a primary goal should be reducing the total amount of impervious surface. This includes rooftops, roadways, parking lots, driveways, sidewalks and soils compacted by vehicular and repeated overland traffic. Expansive areas of lawn must also be avoided in order to maintain the ability of native soils to remain optimally pervious.

**Definition:** Impervious surface -- "those surfaces in the landscape that cannot infiltrate rainfall".

*2000 Maryland Stormwater Design Manual, MDE, Volume I, glossary, draft, 1999.*

Reducing site imperviousness directly reduces the volume of stormwater runoff, reduces the peak rate of runoff, and reduces pollutants generated.<sup>1</sup> It also means there is less need for stormwater mitigative, storage and detention measures.<sup>2</sup>

Ways to reduce impervious coverage include but are not limited to:<sup>3</sup>

- ✓ Cluster (open space) development that maximizes open space;
- ✓ Minimize road lengths and widths, smaller turnarounds;
- ✓ Re-evaluate parking needs: smaller ratios, smaller stalls, angled parking, unpaved spillover parking;
- ✓ Use of porous pavement;
- ✓ Reduce building setbacks;
- ✓ Minimize driveway widths and lengths, shared drives;
- ✓ Re-evaluate need and type of walkway paths: narrower walkways, walkways on only one side of the street;

### Minimizing Imperviousness through Clustering:

Reducing lot size and using an open space design approach to site design through clustering, reduces total imperviousness of each development, all else being equal, because the developed area is concentrated into discreet portions of the site reducing the need for roads, parking areas, sidewalks and excessive lawns. <sup>4</sup> Effective cluster design maximizes preservation of open space and natural areas which in turn encourages infiltration of rainfall and balancing of the site's water cycle.

<sup>1</sup> DNREC and Brandywine Conservancy, Conservation Design for Stormwater Management: A Design Approach to Reduce Stormwater Impacts from Land Development and Achieve Multiple Objectives Related to Land Use, September, 1997, p. 4-16

<sup>2</sup> DNREC and Brandywine Conservancy, Conservation Design for Stormwater Management: A Design Approach to Reduce Stormwater Impacts from Land Development and Achieve Multiple Objectives Related to Land Use, September, 1997, p. 4-16 and 4-25

<sup>3</sup> DNREC and Brandywine Conservancy, Conservation Design for Stormwater Management: A Design Approach to Reduce Stormwater Impacts from Land Development and Achieve Multiple Objectives Related to Land Use, September, 1997, p. 4-16; 2000 Maryland Stormwater Design Manual, MDE, Volume I, glossary, draft, 1999

<sup>4</sup> DNREC and Brandywine Conservancy, Conservation Design for Stormwater Management: A Design Approach to Reduce Stormwater Impacts from Land Development and Achieve Multiple Objectives Related to Land Use, September, 1997, p. 4-16



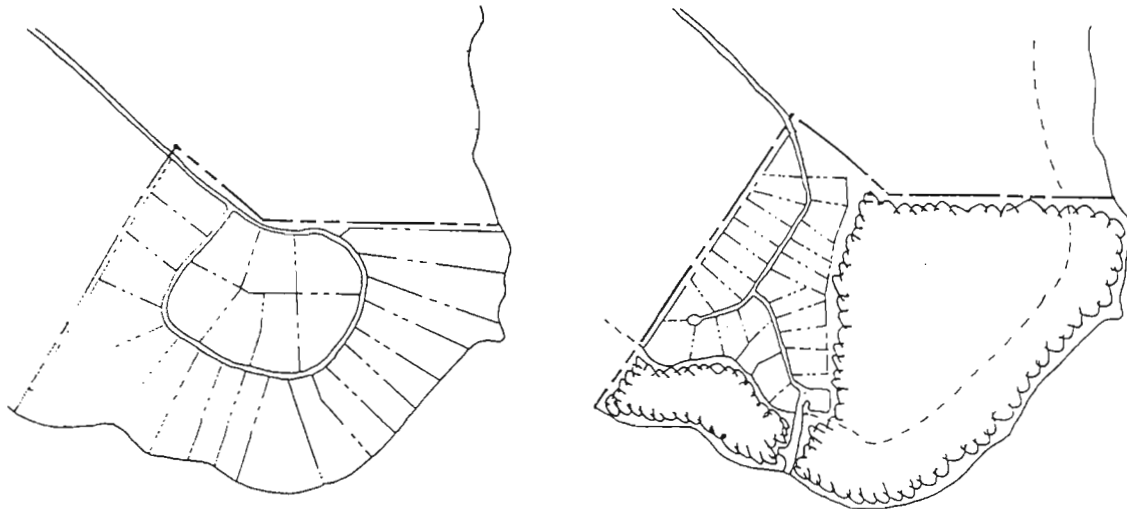

### Cluster versus Traditional Site Development

Open Space Design, more commonly known as cluster development, is a development design approach which reduces the imprint of disturbance on a site by reducing lot size to the maximum and concentrating residential units into the least sensitive portions of a site. The cluster approach is beneficial because it reduces impervious cover, avoids sensitive site features, reserves site open space, and leaves protective buffers in place. Care should be taken to ensure that cluster development does not create water and sewer capacity that encourages sprawl development. An open space design may make use of existing infrastructure, including water and sewer lines, or may be implemented with onsite water and sewer systems, using any number of innovative land-based systems. Successful open space designs can be created which recycle water, both wastewater and stormwater, to the maximum extent, generating minimal water quality impacts.

*Site Planning for Urban Stream Protection, Center for Watershed Protection, co-published by the Metropolitan Washington Council of Governments, December 1995*

### Minimizing imperviousness by narrowing street widths:

Roadways typically make up a large part of total site imperviousness. Reducing road widths from the typical 32-foot width to somewhere between 16 and 22 feet reduces stormwater runoff and pollution loadings. Streets contribute higher loads of pollutants to urban stormwater than any other source areas in residential developments and are a significant source of runoff volume.<sup>5</sup> A

Pollutants from roadways result from several different sources: atmospheric deposition, vehicle emissions, pavement deterioration, tire and brake pad wear, pet waste, and lawn runoff. Pollutants include: sediment, phosphorous, copper, zinc, coliform bacteria and others.

<sup>5</sup> Center for Watershed Protection, *Better Site Design: A Handbook for Changing Development Rules in Your Community*, August, 1998, p. 55



reduction of road width from 30 ft to 18 ft translates into 40% reduction in roadway imperviousness.<sup>6</sup>

Reduced road widths have the added benefit of traffic calming -- the reduced widths force cars to drive slower, reducing the chances of accident. Indeed, as street widths narrow, speed limits tend to drop.<sup>7</sup> For instance, a 26-foot wide standard residential street requires a 25-mph limit; a 16-foot lane requires a 15-mph speed limit.<sup>8</sup>

Narrower roads save developers money. Street paving costs approximately \$15 per square yard.<sup>9</sup> Reducing a road from the typical 32 ft width to a 20 foot width reduces the amount of pavement by 37.5% which translates into 63,360 square feet (approximately 1 1/2 acres) per linear mile.<sup>10</sup>

In some cases, road widths must be expanded. For example, in neo-traditional design nodes where lot sizes have been reduced to the maximum (5,000--6,000 square feet) and driveways are very short. On-street parking may be required, necessitating wider roads. The focus on narrower roads applies to large-lot low-density subdivisions, with very low traffic generation and where wide roads never will be needed.

#### **Minimizing imperviousness in cul-de-sacs:**

While traditionally cul-de-sacs require a radius of 50 to 60 feet, they can serve their function with a radius of 33 to 45 feet.<sup>11</sup> And there are other ways to reduce their imperviousness:

- ✓ create a center island that is vegetated with native plants (low growing shrubs or ground covers can address any concerns about sight impairment);
- ✓ underlay cul-de-sacs with recharge beds, using the center island as the recharge inlet;
- ✓ T-shaped turnarounds that can have 75% less impervious cover than a 40-foot radius circle -- minimum size for this is 60 ft by 20 ft;<sup>12</sup>
- ✓ loop roads that can also reduce overall imperviousness.<sup>13</sup>

Concerns about narrower roads and smaller cul-de-sacs have been expressed by emergency personnel and maintenance crews. However, it is possible for the narrower widths to be

<sup>6</sup> DNREC and Brandywine Conservancy, Conservation Design for Stormwater Management: A Design Approach to Reduce Stormwater Impacts from Land Development and Achieve Multiple Objectives Related to Land Use, September, 1997, p. 4-16

<sup>7</sup> Center for Watershed Protection, Better Site Design: A Handbook for Changing Development Rules in Your Community, August, 1998, p. 30

<sup>8</sup> Center for Watershed Protection, Site Planning for Urban Stream Protection, co-published by the Metropolitan Washington Council of Governments, December 1995

<sup>9</sup> Center for Watershed Protection, Better Site Design: A Handbook for Changing Development Rules in Your Community, August, 1998, p. 32

<sup>10</sup> Arnold and Gibbons, "Impervious Surface Coverage, the Emergence of a Key Environmental Indicator", *APA Journal*, Spring 1996

<sup>11</sup> Center for Watershed Protection, Better Site Design: A Handbook for Changing Development Rules in Your Community, August, 1998, p. 49

<sup>12</sup> Center for Watershed Protection, Better Site Design: A Handbook for Changing Development Rules in Your Community, August, 1998, p. 50

<sup>13</sup> Center for Watershed Protection, Better Site Design: A Handbook for Changing Development Rules in Your Community, August, 1998, p. 51



accommodated by large equipment, especially if curbing is eliminated or reduced. Also, in many instances, access can be provided by an unpaved but reinforced shoulder on one or both sides of a main road (block pavers can be placed under the soil and filled with dirt and grass).

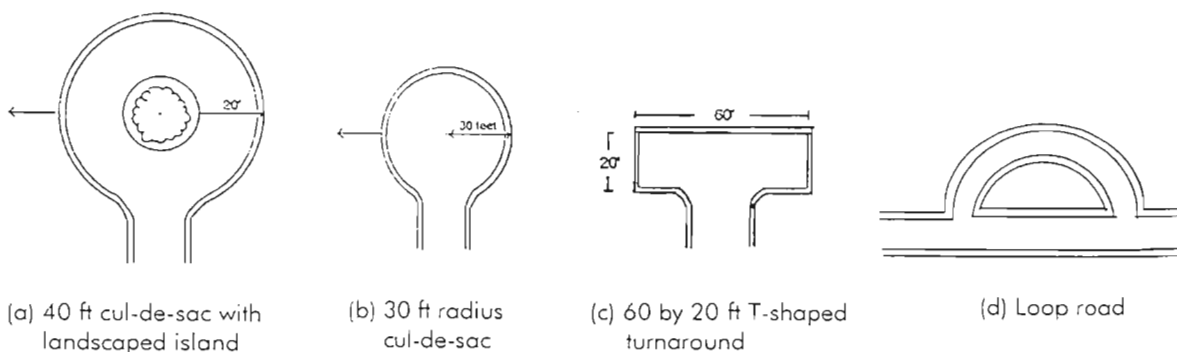

### Some alternative approaches for turnarounds

*"Better Site Design: A Handbook for Changing Development Rules in Your Community", Center for Watershed Protection, August, 1998*

#### Minimizing imperviousness associated with parking:

Parking needs are often overestimated. Parking stall sizes should be reduced from the standard 10 X 20 feet to 9 X 18 feet with 7.5 X 15 feet being provided for compact cars.<sup>14</sup>

Pollutants contributed by parking lots include total suspended solids, phosphorus, copper, cadmium and zinc.

And, there are a number of other ways to minimize the imperviousness of parking:

- ✓ Build lots using porous paving underlain by recharge beds;
- ✓ Reduce the number of parking spaces needed by making projections of peak parking needs more realistic;
- ✓ Implement shared parking and mass transit credit programs that reduce the need for parking spaces;
- ✓ Reduce the overall size of the lot with compact car spaces;
- ✓ Differentiate between primary and spillover parking areas—use alternative pavers such as grid pavers, grass or porous paving for spillover parking;
- ✓ Encourage alternative parking structures, including multiple level;
- ✓ Use of one-way angled parking can also decrease total lot size.<sup>15</sup>

<sup>14</sup> DNREC and Brandywine Conservancy, Conservation Design for Stormwater Management: A Design Approach to Reduce Stormwater Impacts from Land Development and Achieve Multiple Objectives Related to Land Use, September, 1997, p. 3-28

<sup>15</sup> DNREC and Brandywine Conservancy, Conservation Design for Stormwater Management: A Design Approach to Reduce Stormwater Impacts from Land Development and Achieve Multiple Objectives Related to Land Use, September, 1997, p. 3-28



### Minimizing imperviousness associated with other amenities:

Other site design techniques that can reduce impervious cover include:

✓ Avoid traditional lawns. Instead, preserve or restore trees, shrubs and other native plants as woodland areas on a lot, which reduces stormwater runoff, provides wildlife habitat and home cooling in hot summer months, and increases market value. Turf grass does not have the same ability to infiltrate as trees and shrubs and other plants with deeper root systems, which help soil capture, hold and infiltrate rainwater. In addition, turf grass is often planted on soils that have been compacted during construction and therefore have limited capacity for rainwater capture and infiltration. Also, the naturally absorbent topsoil has usually been removed, contributing to the turf's inability to hold rainwater. While trees, shrubs, and deeply rooted plants can help rehabilitate these soils for infiltration, grass cannot. Finally, lawns are not accompanied by the humus layer that is found in heavily vegetated areas and which is generally the most absorbent layer of soil.

Surveys show that conserving forests on residential and commercial development sites can enhance property market value by up to 15%.

*Better Site Design: A Handbook for Changing Development Rules in Your Community by Center for Watershed Protection, 1992*

Driveways make up as much as 20% of the impervious cover in a traditional residential subdivision.

*Better Site Design: A Handbook for Changing Development Rules in Your Community by Center for Watershed Protection, 1992*

✓ Driveway length is dictated in large part by the setback associated with a lot. Reduced setback requirements result in reduced driveway length and therefore less impervious area.<sup>16</sup> Other ways to reduce the imperviousness associated with driveways are to encourage common or shared driveways, to reduce driveway widths from 20 to 18 feet, and/or to use porous paving materials.<sup>17</sup>

✓ Either eliminate sidewalks or provide for more flexible sidewalk requirements: only requiring sidewalks on one side of the street; reducing width requirements to 3 or 4 feet rather than the standard 5 to 6 feet<sup>18</sup> (although a wider width sidewalk on one side of the street is often preferable); designing sidewalks to discharge stormwater to neighboring lawns;<sup>19</sup> using more pervious material such as gravel; requiring a bicycle lane as part of the roadway on less trafficked roads. It is important to encourage foot and bicycle traffic,

<sup>16</sup> DNREC and Brandywine Conservancy, Conservation Design for Stormwater Management: A Design Approach to Reduce Stormwater Impacts from Land Development and Achieve Multiple Objectives Related to Land Use, September, 1997, p. 3-28

<sup>17</sup> DNREC and Brandywine Conservancy, Conservation Design for Stormwater Management: A Design Approach to Reduce Stormwater Impacts from Land Development and Achieve Multiple Objectives Related to Land Use, September, 1997, p. 3-28

<sup>18</sup> Center for Watershed Protection, Better Site Design: A Handbook for Changing Development Rules in Your Community, August, 1998

<sup>19</sup> DNREC and Brandywine Conservancy, Conservation Design for Stormwater Management: A Design Approach to Reduce Stormwater Impacts from Land Development and Achieve Multiple Objectives Related to Land Use, September, 1997, p. 3-28





therefore sidewalk elimination should be balanced by shared roadway use or unpaved or porous paths on the shoulders of roads.

1. Reduce residential road widths	13. Vertical parking structures
2. Shorter road lengths	14. Require open space/green space
3. Cul-de-sac donuts	15. Require buffers
4. Disconnect roof leaders	16. Swales rather than curb/gutters
5. Cluster development	17. Encourage runoff to pervious surfaces
6. Angled parking	18. Commercial open space landscaping
7. Smaller parking stalls	19. Sidewalks on one side of street
8. Reduced parking ratios for some land uses	20. Reduce setbacks and frontage
9. Shared parking and driveways	21. Flexible minimum lot sizes
10. Shorter residential driveways	22. "Hourglass" streets
11. Reduced cul-de-sac radii	23. T or V shaped turnarounds
12. Taller buildings (with higher FAR ratios)	24. Permeable spillover parking areas

**Some ways to minimize impervious cover on a development site**

*Site Planning for Urban Stream Protection, by the Center for Watershed Protection, co-published by the Metropolitan Washington Council of Governments, December 1995, adapted from Wells 1994, Schueler 1994, PZC, Inc., 1992.*



## Fact Sheet -- Stormwater Runoff, the Lost Resource Encouraging Open Space (Cluster) Designs

Open space design (more commonly known as clustering) can be used to leave the most environmentally sensitive areas of the site undisturbed and protected as open space. It also protects the areas that can be most beneficial for stormwater infiltration and overall management. Open space designs can reduce impervious cover by 40 to 60 percent and thereby reduce annual stormwater runoff volume by equal, even greater volumes -- 20 to 60 percent when compared to conventional subdivision designs.<sup>1</sup> Reduced imperviousness resulting from grading and compaction is reduced as well. This also translates into an increase in the amount of infiltration and groundwater recharge occurring on a site, and a reduction in nonpoint source pollution. Studies have found reductions of 40 to 80% in phosphorus load, 40 to 70% in nitrogen load, and up to 90% total suspended solids reduction when a site incorporates open space.<sup>2</sup>

**Definition:** Total Suspended Solids (TSS) -- "the total amount of particulate matter that is suspended in the water column".

*2000 Maryland Stormwater Design Manual, MDE, Volume I, glossary, draft, 1999.*

Open space design reduces the imprint of disturbance on a site by concentrating residential units into the least environmentally sensitive portions of a site. The cluster approach is beneficial because it reduces impervious cover, reserves most of the site as open space and leaves protective buffers in place around sensitive features.<sup>3</sup> Care should be taken to ensure that cluster development does not create water and sewer capacity that encourages sprawl development.<sup>4</sup>

✓ Open space design has been shown to increase land values from 5 to 32%.<sup>5</sup>

✓ The reduced impervious cover and smaller structural stormwater management conveyance systems that are required by open space design makes them significantly less expensive to build, with infrastructure construction cost savings ranging from 11 to 66 percent.<sup>6</sup>

<sup>1</sup> Center for Watershed Protection, Better Site Design: A Handbook for Changing Development Rules in Your Community, August, 1998, p. 94; DNREC and Brandywine Conservancy, Conservation Design for Stormwater Management: A Design Approach to Reduce Stormwater Impacts from Land Development and Achieve Multiple Objectives Related to Land Use, September, 1997, p. 3-21

<sup>2</sup> Center for Watershed Protection, Better Site Design: A Handbook for Changing Development Rules in Your Community, August, 1998, p. 95

<sup>3</sup> Center for Watershed Protection, Site Planning for Urban Stream Protection, co-published by the Metropolitan Washington Council of Governments, December 1995

<sup>4</sup> Center for Watershed Protection, Site Planning for Urban Stream Protection, co-published by the Metropolitan Washington Council of Governments, December 1995

<sup>5</sup> DNREC and Brandywine Conservancy, Conservation Design for Stormwater Management: A Design Approach to Reduce Stormwater Impacts from Land Development and Achieve Multiple Objectives Related to Land Use, September, 1997, p. 3-24

<sup>6</sup> Center for Watershed Protection, Better Site Design: A Handbook for Changing Development Rules in Your Community, August, 1998, p. 99



✓ Open space designs are also very marketable. A number of studies show that these developments can command significantly higher prices per home. For example, in Bucks County, PA, in the Fairview subdivision 23% of the property in the subdivision was preserved as open space with 31% preserved as productive farmland. It is the "fastest selling subdivision in its price range with lots from 1/2 to 1/3 the size of competing projects."<sup>7</sup>

✓ Clustering can reduce the cost of municipal services such as trash removal, street maintenance, water and sewer line maintenance, and lighting.<sup>8</sup>

✓ Open space design reduces the amount of cover associated with parking lots, driveways, residential roads and sidewalks, resulting in not only environmental benefits but also a direct construction cost savings to the developer. Savings are realized as both reduced construction costs and reduced need for stormwater management systems.

**Clustering Reduces Costs by:**

- ✓ Reducing land clearing
- ✓ Reducing road construction (including curbing)
- ✓ Reducing sidewalk construction
- ✓ Fewer street lights
- ✓ Less street planting and landscaping
- ✓ Reduced sanitary sewer line and water line footage
- ✓ Reduced stormwater sewers
- ✓ Reduced need for stormwater basin construction

**Encouraging Open Space Design**

In order to encourage use of a clustering approach, applicable ordinances should allow the same number of units as traditional zoning. While in some cases cluster ordinances allow for a greater number of units, communities should not feel compelled to allow a greater number of units as an enticement for a cluster approach. The cost savings and increased marketability that is generally associated with cluster developments should be enough to encourage this approach, without giving a bonus that actually reduces the amount of the site which could otherwise be protected.

**Benefits of clustering:**

- ✓ Reduced site imperviousness;
- ✓ Preserves sensitive site features;
- ✓ Protects habitats;
- ✓ Improves aesthetics;
- ✓ Maintains passive recreation and open space areas;
- ✓ Reduces development, maintenance and community costs;
- ✓ Increases property values.

Generally open space designs are offered as an option in municipal ordinances and frequently require a special, more cumbersome review process -- they need to become mandatory wherever possible with permitting/zoning/variance processes that are at

least equivalent to that of conventional, by-right developments. More stringent, costly and time-consuming requirements for open space designs are a significant disincentive for developers to use this approach.

<sup>7</sup> Center for Watershed Protection, Better Site Design: A Handbook for Changing Development Rules in Your Community, August, 1998, p. 97

<sup>8</sup> DNREC and Brandywine Conservancy, Conservation Design for Stormwater Management: A Design Approach to Reduce Stormwater Impacts from Land Development and Achieve Multiple Objectives Related to Land Use, September, 1997, p. 3-24



There is a frequent tension confronted by planners crafting clustering provisions. On the one hand, there is clearly a need for more reviewing and input by municipal officials during the approval process. At the same time, establishing elaborately structured performance standards can be an enormous deterrent to the clustering option, if required for clusters but not for conventional. A partial response can be to structure into the municipal reviewing process a greater degree of environmental review for conventional developments, known to have greater environmental impacts. Possible environmental assessments and impact statements should be required for conventional by-right designs, though waived or scaled back for open space clustering designs -- as long as definite standards are met by the cluster approach (i.e. percent of imperviousness, buffer zones, protecting existing natural features, infiltration BMPs). Other procedural incentives, positive and negative, can be developed. And in fact a municipality can certainly establish the open space/cluster design as by-right, with conventional large lot development as an option.

The Growing Greener program, as developed by Randall Arendt for the Pennsylvania Department of Conservation and Natural Resources, provides some excellent additional guidance on clustering.

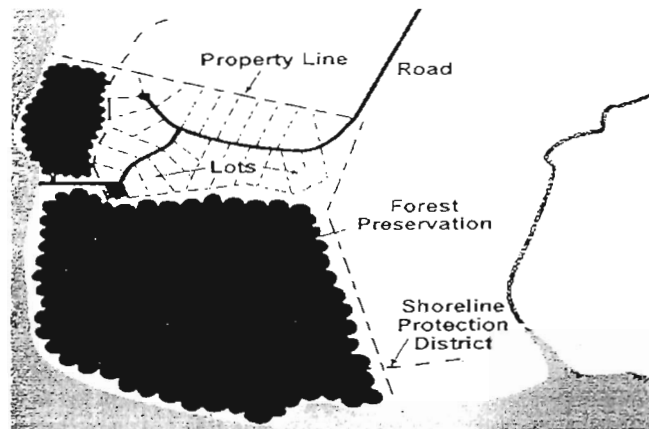
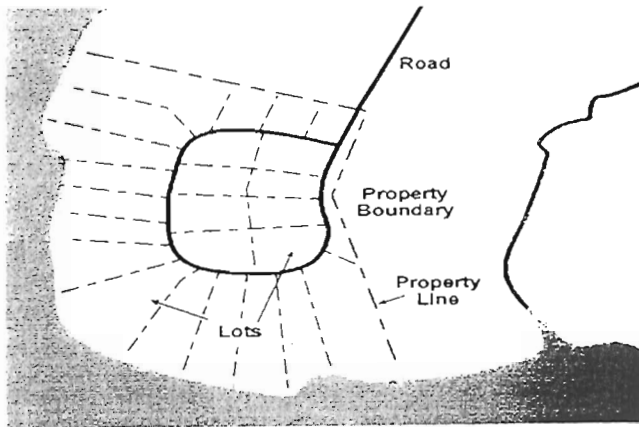

**Open space design protects natural resources without diminishing the number of lots**

*"Better Site Design: A Handbook for Changing Development Rules in Your Community",  
Center for Watershed Protection, August, 1998*



*Porous paving with recharge trenches.*



*Porous paving (to left of white line) infiltrates rainfall and runoff from impervious paving (to right of line).*



*Simple infiltration . . .*

*routes runoff to  
vegetated depressions;*

*routes downspouts  
to gardens,  
plantings or  
recharge systems.*



## B. Other Stormwater Best Management Practices -- Infiltrating Stormwater Once the Damage is Done

When land is developed, even if minimum disturbance practices are employed, the landscape and its natural function are indelibly changed. In order to compensate for the loss of the natural landscape and its inherent water resource protection functions, a variety of other stormwater best management practices (BMPs) can be employed. Considering our goal to first protect and second restore the natural stormwater patterns of an existing site (see Chapter 2B), the best management practices are those that mimic nature by infiltrating rainfall.

Implementation of stormwater infiltration "has prevented or solved problems of flooding, storm sewer cost, water quality, wetland maintenance, and replenishment of groundwater and stream base flows".

*Bruce K. Ferguson, Stormwater Infiltration,  
CRC Press, 1994, p. 3*

When infiltration is not an option, best management practices seek to employ approaches, which reduce the peak rate of runoff and/or remove pollutants from stormwater runoff thereby improving the quality of the discharge.

Depending on specific site considerations, BMPs sometimes work best in a series. Source controls, followed by open conveyance swales (i.e. grassy swales) and/or native vegetation, followed by constructed wetlands, and/or a wet pond or

infiltration basin, can provide multiple benefits (i.e. improving water quality and recharging groundwater) when single solutions are not effective.<sup>155</sup>

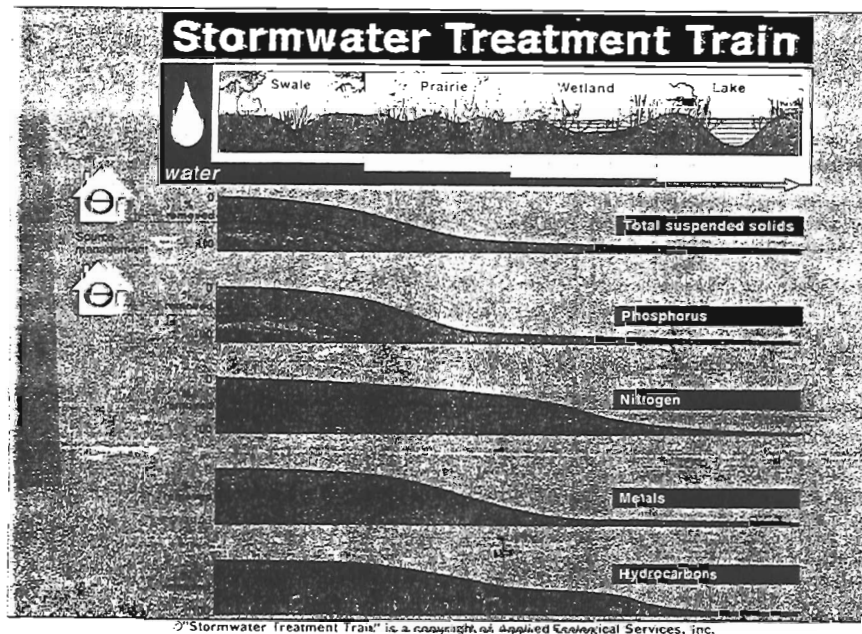

### Stormwater treatment trains reduce pollutants

*Jack Broughton and Steve Apfelbaum, "Using Ecological Systems for Alternative Stormwater Management", Land and Water, Sept/Oct 1999.*



Successful use of best management practices is only limited by our imaginations. There are a wide-array of proven techniques that can be employed.

The most effective are those that are focused on preventing stormwater runoff and nonpoint source pollution such as:<sup>156</sup>

- ✓ protection of existing natural areas;
- ✓ stringent construction regulations and effective stormwater and development regulations for areas being redeveloped that require designs to minimize land disturbance and impervious cover;
- ✓ removal or reduction of impervious surfaces such as unnecessary parking lots, replacing them with “vest pocket parks”, vegetated infiltration strips, and other ecological restoration and retrofit measures;
- ✓ diligent enforcement of regulations through regular inspection;
- ✓ anti-litter ordinances and educational programs (such as stenciled catch basins and inlets);
- ✓ protecting and restoring riparian buffers;
- ✓ stream bank restoration;
- ✓ erosion controls and re-vegetation of existing development commons, parks, and open space;
- ✓ regulations controlling herbicide and pesticide usage;
- ✓ air pollution abatement;
- ✓ cleaning of catch basins, sewer pipes and street cleaning;
- ✓ improved de-icing methods;
- ✓ spill containment systems for facilities that use and store chemicals.

In instances where prevention is impossible, mitigative measures can be employed. BMPs that mitigate stormwater runoff impacts from urbanizing and built-out areas provide tremendous benefit in terms of reduced flood flows, decreased sedimentation to streams, and improved water quality. Examples of this approach include:

- ✓ stormwater infiltration systems;
- ✓ reduce contiguous pavement;
- ✓ porous pavement with recharge technology;
- ✓ rooftop ponding, vegetated rooftops;
- ✓ grade stabilization;
- ✓ vegetated trenches;
- ✓ grassed swales;
- ✓ filter strip, bio-retention filters;
- ✓ small vegetated areas;
- ✓ rain gardens;
- ✓ interrupted parking lot areas employing infiltration trenches;
- ✓ dry wells;
- ✓ wet ponds and artificial or created wetlands;
- ✓ depressed islands in parking lots with bioretention filters.

When planning stormwater management practices sometimes the best solution is a mix of many small solutions. The goal of each is to capture stormwater and infiltrate it back into the ground as close to the source as possible.

Stormwater BMPs generally fall into two groups: living BMPs and structural BMPs. Living BMPs rely on plants to provide or enhance stormwater control. On the whole, living BMPs



are more broadly beneficial because they achieve multiple purposes -- you get more bang for your buck. While preventing, managing and treating stormwater, living BMPs also provide habitat, enhance the local ecosystem, and enhance our quality of life. When creating living BMPs, care must be taken to design with nature and to choose plants that are native and appropriate. Knowledgeable professionals and nurseries can guide this process. Factors that need to be considered include: inundation tolerance; pollution tolerance; salt tolerance; hardiness zones and aesthetics.

Structural BMPs require construction of a structure and use of non-living materials to capture runoff and encourage infiltration. Structural BMPs can be very effective for runoff control and providing water quality benefits but they lack the overall ecosystem benefits provided by systems that rely on, encourage and incorporate vegetation. Although, to a large extent, the ecological benefits of structural BMPs can be enhanced by incorporating plant life to the greatest extent possible.

All stormwater management facilities require maintenance, whether it is an infiltration best management practice or a more traditional detention basin system. It's a common misconception that best management practices require more maintenance than the traditional approach. As a matter of fact, because most BMPs do not have inlets and other hard infrastructure, and because they need little or no mowing or chemical fertilizing, maintenance is usually less demanding.

An effective and well-implemented inspection and maintenance program should ensure a long life for stormwater best management practices. When water quality and other community benefits associated with infiltration and best management practices are considered, the time and resources invested in inspection and maintenance are well worth it.

## **1. Fact Sheets**

The following fact sheets provide information on specific BMPs and will help in planning and evaluating which to use for site specific situations. Design and construction of BMPs will require professional services.

Fact sheets are designed to be stand-alone tools that can be copied and shared to help inform others on the issues.





## Fact Sheet -- Stormwater Runoff, the Lost Resource Recharge Gardens/Rain Gardens

Recharge gardens, also known as rain gardens, are small bioretention areas with a strong emphasis on aesthetics. These bioretention areas are placed in individual gardens.

Recharge/Rain Gardens capture rainfall and recharge it to the soil on a lot-by-lot basis. The gardens can be discreet units placed around the site and must be tailored to soil type, existing hydrologic conditions, sunlight and other site-specific factors in order to be successful—that is, in order to sustain the native plantings. The aesthetic value of recharge gardens provides ancillary benefits for people and for the flora and fauna that move in, such as improved habitat, cover, food, noise buffer and quality of life benefits.

**Definition:** Bioretention areas -- a shallow depression combined with a mixture of sand and soils that are planted with native vegetation that filter urban runoff.

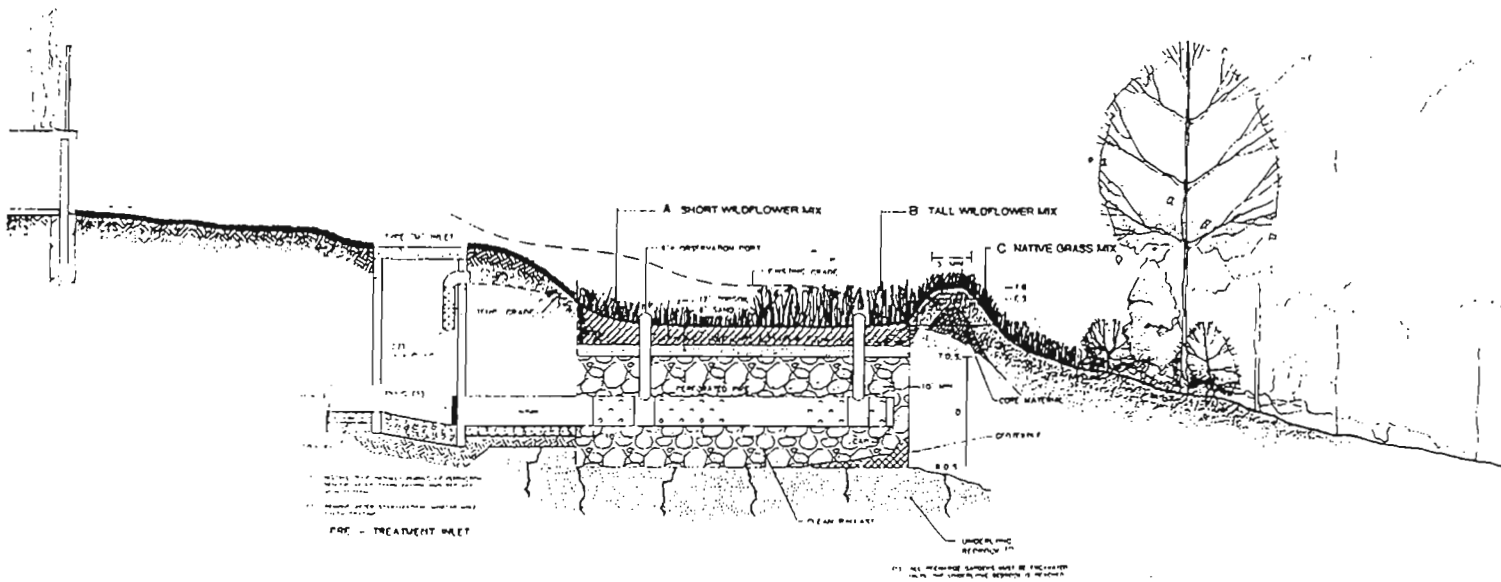

TYPICAL PROFILE VIEW  
(M.T.S.)

### Recharge garden plans

*"Conservation Design Strategies for Stormwater Management: Integrating Native Plants at the Rivercrest Golf Community Upper Providence, Montgomery County, PA", Horner and Harper, 1999.*



A big advantage of recharge or rain gardens is that they are inexpensive to install and maintain and can be retrofitted into existing developments. The individual nature of a recharge garden, which can be fine-tuned by the homeowner or groundskeeper, allows this highly functional low-tech BMP to become a personal asset. The enjoyment that comes from watching butterflies and birds or listening to frogs on a spring evening, cannot be matched by the pipes and gutters that are usually the homeowner's piece of a stormwater system.

### Maintenance

Carefully planned specifications for the installation of a recharge garden are based on drainage and other site-specific conditions, and result in a low maintenance recharge garden. Occasional removal of invasive species should be done manually. Pesticide and herbicide application should be avoided except for organic, non-toxic controls. Starting with properly selected native plants that need minimum maintenance is key.

Appendix A includes an expanded but by no means complete list of plants native to the region as well as some local suppliers.

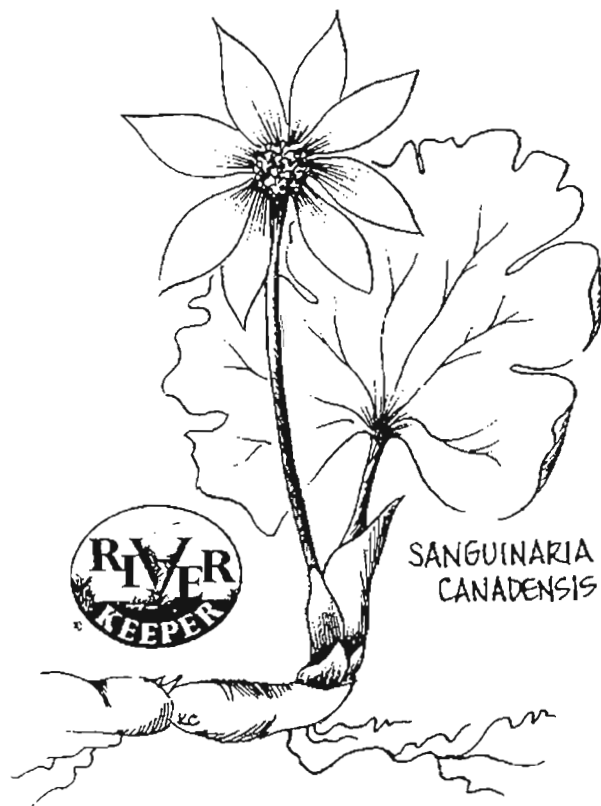

## Fact Sheet -- Stormwater Runoff, the Lost Resource Vegetated Filter Strips and Buffers

### Vegetated Filter Strips

Vegetated filter strips are made up of close-growing grasses or other densely planted vegetation established at the perimeter of disturbed or impervious areas to intercept runoff in sheet flow. The vegetation slows the stormwater flow allowing particulate pollutants (primarily sediments but also nutrients, metals and organics generally adhered to particles such as sediments) to fall out.<sup>1</sup> Non-soluble pollutant removal rates can be as high as 80% to 90%. Soluble pollutants (nutrients, some metals) can be removed by plant uptake if the soil has a high rate of percolation. Also, storm flows are slowed, allowing some pollutants to be treated, particularly in smaller storm events in low-density developments.<sup>2</sup> A filter strip is particularly effective in preserving the riparian zone or streambanks when heavily vegetated with woody plants.

**Definition:** Vegetated filter strip -- a strip of permanent vegetation that receives runoff in the form of sheet flow from upslope impervious areas and provides protection to waterways or stormwater management facilities. Vegetation can range from grass to forest.

2000 Maryland Stormwater Design Manual, MDE, Volume I, draft, 1999

Passage through a vegetated filter strip can reduce annual storm runoff volumes by up to 40%.<sup>3</sup> As stormwater passes through the filter strip the runoff is slowed and given the opportunity to infiltrate, reducing volume of runoff, peak flow and increasing the time of concentration. While a filter strip cannot handle very high levels of stormwater flow, it can be very effective as part of an integrated series of stormwater practices and it can often reduce the necessary size of the receiving detention basin or BMP.<sup>4</sup>

Because they effectively filter out pollutants and provide an opportunity for additional infiltration and flow reduction, filter strips should be used to the

**Definition:** Time of concentration - "time required for water to flow from the most remote point of a watershed [or site], in a hydraulic sense, to the outlet [or waterway]"

2000 Maryland Stormwater Design Manual, MDE, Volume I, glossary, draft, 1999.

<sup>1</sup> DNREC and Brandywine Conservancy, Conservation Design for Stormwater Management: A Design Approach to Reduce Stormwater Impacts from Land Development and Achieve Multiple Objectives Related to Land Use, September, 1997, p. 2-25

<sup>2</sup> DNREC and Brandywine Conservancy, Conservation Design for Stormwater Management: A Design Approach to Reduce Stormwater Impacts from Land Development and Achieve Multiple Objectives Related to Land Use, September, 1997, p. 3-39

<sup>3</sup> Northeastern Illinois Planning Commission, "Reducing the Impacts of Urban Runoff: The Advantages of Alternative Site Design Approaches", April, 1997.

<sup>4</sup> DNREC and Brandywine Conservancy, Conservation Design for Stormwater Management: A Design Approach to Reduce Stormwater Impacts from Land Development and Achieve Multiple Objectives Related to Land Use, September, 1997, p. 3-39



greatest extent possible as an alternative to storm sewers and lined channels. Directing runoff from impervious surfaces such as rooftops, parking lots and/or roadways through filter strips provides an important opportunity for cleansing and infiltrating runoff.

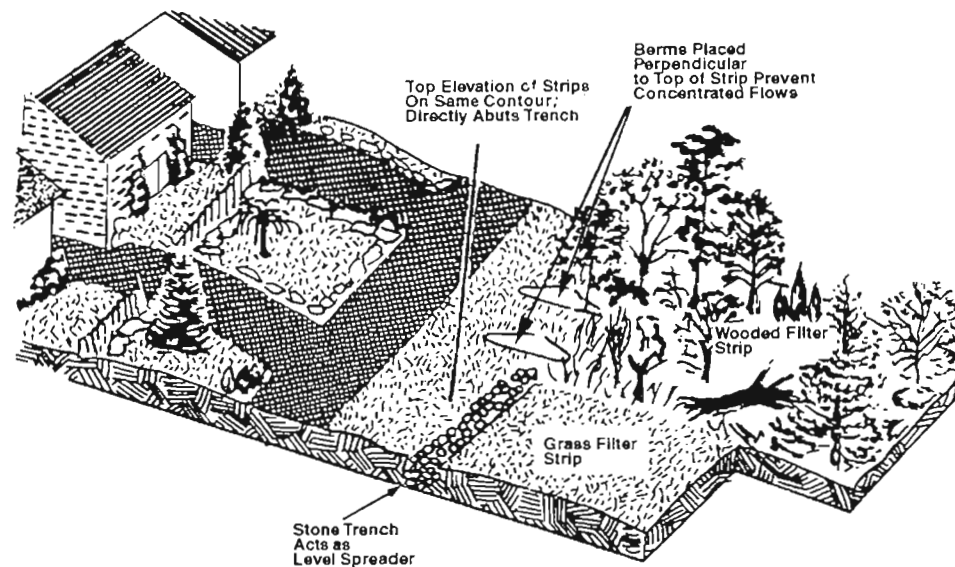

### Filter Strip

*Reprinted from "Protecting Natural Wetlands; A Guide to Stormwater Best Management Practices, USEPA, October, 1996*

### Design Considerations

✓ In filter strip design the objective is to distribute storm flows, intercepting them before they become substantially concentrated and distributing this flow evenly through a vegetated filter strip.<sup>5</sup>

✓ Design criteria require: slopes less than 15%; a level-spreading device such as a shallow stone trench which follows the contour at the top of the strip; dense vegetation with a mix of erosion-resistant plant species, preferably trees rather than grass; grading to a uniform, even and relatively low slope; a contributing runoff area that is, at a minimum, 20 feet wide, preferably 50-75 feet wide; the top edge of the filter strip should follow the same contour and should directly abut the impervious area; careful preparation before planting (ie. tilled, re-graded and seeded) to eliminate any compaction or sedimentation which may impede the performance and plant viability.<sup>6</sup>

✓ Soil permeability in the planting area should be good enough to support vegetation. Soil amendments can be added to the planted area to improve the soil's ability to capture rainwater

<sup>5</sup> DNREC and Brandywine Conservancy, Conservation Design for Stormwater Management: A Design Approach to Reduce Stormwater Impacts from Land Development and Achieve Multiple Objectives Related to Land Use, September, 1997, p. 3-39

<sup>6</sup> New York State Department of Environmental Conservation, Reducing the Impacts of Stormwater Runoff from New Development, April, 1992

for the plants.<sup>7</sup> This is especially true in the first year or two, when the vegetation is becoming established. As the vegetated strip matures, topsoil and humus build, improving the soil.

- ✓ Vegetation must be vigorous and healthy.<sup>8</sup>
- ✓ Filter strips should be located as close to the runoff source as possible.
- ✓ Filter strips should be integrated into the design so as to control smaller storms with larger storms being re-directed to another BMP.<sup>9</sup>
- ✓ The greatest threat to a filter strip is channelization and concentration of flows -- the filter strip's ability to remove pollutants is compromised or even eliminated, and erosion of soil and vegetation can occur. Infiltration is also reduced.<sup>10</sup>
- ✓ Construction of a filter strip may require specialized lightweight grading equipment to prevent soil compaction and erosion.<sup>11</sup>
- ✓ Filter strips require careful and informed choice of plantings to allow for nutrient uptake and water storage and for strong stem and root systems that increase soil permeability and trap sediments.<sup>12</sup>
- ✓ The filter strip may require the installation of a level spreader such as a gravel filled trench in order to spread out incoming flows.<sup>13</sup>

### Cost

Filter strips are relatively inexpensive and can be integrated into the landscaping cost. By integrating filter strips into the initial design, existing vegetation can be used to the largest extent possible, thereby further reducing costs.<sup>14</sup>

---

<sup>7</sup> 2000 Maryland Stormwater Design Manual, MDE, Volume I, draft, 1999

<sup>8</sup> Pennsylvania Handbook of Best Management Practices for Developing Areas, Prepared by CH2MHILL, Spring 1998

<sup>9</sup> DNREC and Brandywine Conservancy, Conservation Design for Stormwater Management: A Design Approach to Reduce Stormwater Impacts from Land Development and Achieve Multiple Objectives Related to Land Use, September, 1997, p. 3-39

<sup>10</sup> DNREC and Brandywine Conservancy, Conservation Design for Stormwater Management: A Design Approach to Reduce Stormwater Impacts from Land Development and Achieve Multiple Objectives Related to Land Use, September, 1997, p. 3-39

<sup>11</sup> DNREC and Brandywine Conservancy, Conservation Design for Stormwater Management: A Design Approach to Reduce Stormwater Impacts from Land Development and Achieve Multiple Objectives Related to Land Use, September, 1997, p. 3-39

<sup>12</sup> Protecting Natural Wetlands: A Guide to Stormwater Best Management Practices, USEPA, October, 1996, p. 4-35

<sup>13</sup> DNREC and Brandywine Conservancy, Conservation Design for Stormwater Management: A Design Approach to Reduce Stormwater Impacts from Land Development and Achieve Multiple Objectives Related to Land Use, September, 1997, p. 3-39

<sup>14</sup> DNREC and Brandywine Conservancy, Conservation Design for Stormwater Management: A Design Approach to Reduce Stormwater Impacts from Land Development and Achieve Multiple Objectives Related to Land Use, September, 1997, p. 3-39





## Maintenance

Maintenance needs are typically not great, particularly if the design and installation are done well. Inspections during construction are essential and should be conducted at regular intervals until the vegetation is established. After that, annual inspections are adequate to check for vegetation damage, any sign of concentrated flows, and erosion or traffic intrusion. Periodic aeration of soils may be necessary if soils are heavy, if compaction has occurred or if there has been excessive sedimentation on the strip area. Reseeding or re-vegetation may be necessary from time to time, particularly in the first one to three years, or if weather or other conditions are not favorable to plant life. Use of native vegetation will reduce loss of plant material and will minimize maintenance needs. Ideally, filter strips are self-maintaining, with sediment and potential pollutants being utilized and incorporated into the filter strip over time.<sup>15</sup>

## Vegetated Buffers

Vegetated buffers are useful in separating areas with incompatible uses. They can be used to protect sensitive areas such as streams and wetlands, and other BMPs.<sup>16</sup>

**Definition:** Vegetated Buffer –  
A vegetated boundary surrounding ecological site features.

Vegetated natural buffers work in much the same way as filter strips as a stormwater treatment medium, with similar costs and maintenance needs. However, design criteria can be different, depending on specific site conditions and the function the buffer is to fulfill.

Vegetated natural buffers function mainly as water quality BMPs. They also reduce the rate of runoff from adjacent areas and provide opportunity for infiltration and sediment removal. They reduce the potential for channel erosion along a waterway.

It is important that buffers receive runoff as sheet flow so as to prevent channelization and damage, and to encourage the water quality and infiltration benefits they can provide by slowing, filtering and recharging runoff.

---

<sup>15</sup> DNREC and Brandywine Conservancy, Conservation Design for Stormwater Management: A Design Approach to Reduce Stormwater Impacts from Land Development and Achieve Multiple Objectives Related to Land Use, September, 1997, p. 3-39; Protecting Natural Wetlands: A Guide to Stormwater Best Management Practices, USEPA, October, 1996, p. 4-35

<sup>16</sup> DNREC and Brandywine Conservancy, Conservation Design for Stormwater Management: A Design Approach to Reduce Stormwater Impacts from Land Development and Achieve Multiple Objectives Related to Land Use, September, 1997, p. 3-39; Protecting Natural Wetlands: A Guide to Stormwater Best Management Practices, USEPA, October, 1996, p. 4-35

## Fact Sheet -- Stormwater Runoff, the Lost Resource Bioretention

A bioretention filter is a shallow depression combined with a mixture of sand and soils that are planted with native vegetation to filter urban runoff through settling and/or biofiltration. Bioretention facilities retain runoff during the initial stages of a storm, infiltrating much of it.<sup>1</sup> As a result, bioretention facilities can significantly reduce peak runoff rates and recharge groundwater supplies.<sup>2</sup> Bioretention facilities are also effective at removing a wide variety of pollutants, including suspended solids and nutrients. The design of a bioretention facility will determine how effective it is at accomplishing each of these goals.

Bioretention can be used in both residential and nonresidential developments. "Sources of runoff can be overland flow from impervious areas or discharge diverted from a drainage pipe."<sup>3</sup>

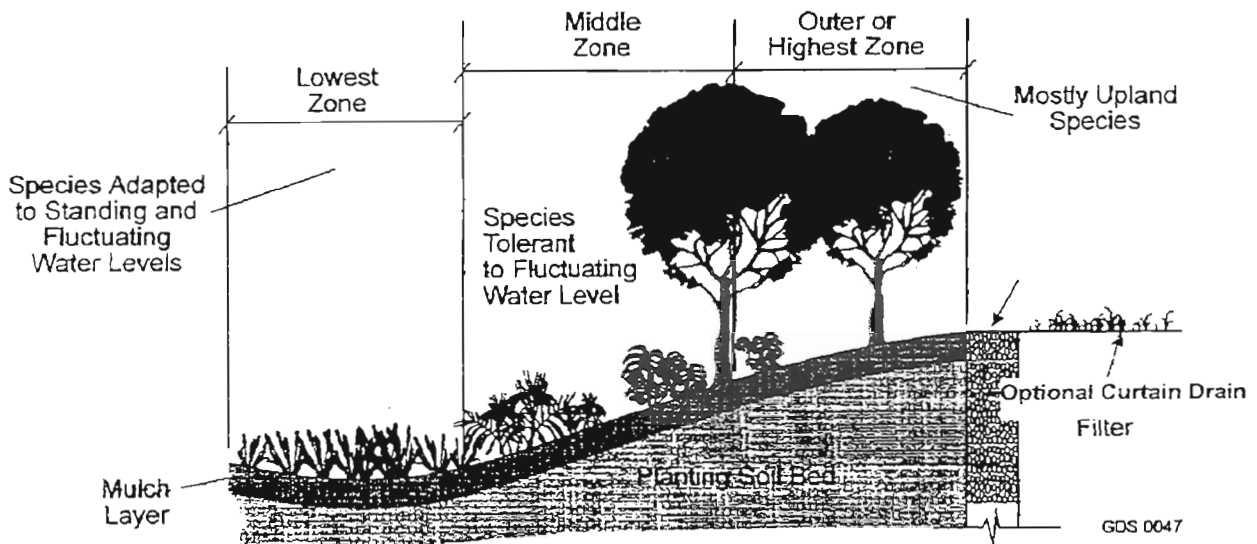

### Bioretention Facility

*2000 Maryland Stormwater Design Manual, MDE, Volume I, draft, 1999*

<sup>1</sup> Pennsylvania Handbook of Best Management Practices for Developing Areas, Prepared by CH2MHILL, Spring 1998

<sup>2</sup> Pennsylvania Handbook of Best Management Practices for Developing Areas, Prepared by CH2MHILL, Spring 1998

<sup>3</sup> Pennsylvania Handbook of Best Management Practices for Developing Areas, Prepared by CH2MHILL, Spring 1998

**There are two general types of bioretention facilities:** off line areas and on line areas.

- ✓ Offline bioretention = "sand and soil mixtures planted with native plants, which receive runoff from overland flow or from a diversion structure in a traditional drainage system."<sup>4</sup> Off line bioretention facilities can be installed in median strips, parking lot islands, or lawn areas of commercial developments.
- ✓ Online bioretention = "areas have the same composition as off-line areas, but are located in grass swales or other conveyance systems that have been modified to enhance pollutant removal" by settling and biofiltration.<sup>5</sup>

**There are six major components to a bioretention area:**<sup>6</sup>

- 1) grass buffer strip or energy dissipation area -- filters particles from the runoff and reduces its velocity.<sup>7</sup>
- 2) ponding or treatment area -- functions as storage area for runoff awaiting treatment and as presettling basin for particulates that have not been filtered by the grass buffer.<sup>8</sup> The treatment area should be planted with species that can withstand inundation and fluctuating water levels.<sup>9</sup>
- 3) soil -- "The planting soil layer nurtures the plants with stored water and nutrients. Clay particles in the soil adsorb heavy metals, nutrients, hydrocarbons, and other pollutants."<sup>10</sup> The soil must be permeable enough (or be amended with soil amendments) to infiltrate runoff and also be able to support robust vegetation.<sup>11</sup> This is particularly true in the start-up phase in order to establish the plant material. As the vegetated area matures, the soil will naturally improve as humus and topsoil build up.
- 4) sand bed (optional) -- further slows the velocity of the runoff, spreads the runoff over the basin, filters part of the water, provides positive drainage to prevent anaerobic conditions in the planting soil, and enhances exfiltration from the basin.<sup>12</sup>
- 5) organic mulch layer -- acts as a filter for pollutants, protects the soil from eroding, and is an environment for microorganisms to degrade petroleum-based compounds and other pollutants.<sup>13</sup> Mulch also helps maintain soil moisture, avoids surface sealing, and traps fine

<sup>4</sup> Pennsylvania Handbook of Best Management Practices for Developing Areas, Prepared by CH2MHILL, Spring 1998

<sup>5</sup> Pennsylvania Handbook of Best Management Practices for Developing Areas, Prepared by CH2MHILL, Spring 1998

<sup>6</sup> Pennsylvania Handbook of Best Management Practices for Developing Areas, Prepared by CH2MHILL, Spring 1998

<sup>7</sup> Pennsylvania Handbook of Best Management Practices for Developing Areas, Prepared by CH2MHILL, Spring 1998

<sup>8</sup> Pennsylvania Handbook of Best Management Practices for Developing Areas, Prepared by CH2MHILL, Spring 1998

<sup>9</sup> 2000 Maryland Stormwater Design Manual, MDE, Volume I, draft, 1999, p. A-12, 13, 14

<sup>10</sup> Pennsylvania Handbook of Best Management Practices for Developing Areas, Prepared by CH2MHILL, Spring 1998

<sup>11</sup> 2000 Maryland Stormwater Design Manual, MDE, Volume I, draft, 1999, p. A-12, 13, 14

<sup>12</sup> Pennsylvania Handbook of Best Management Practices for Developing Areas, Prepared by CH2MHILL, Spring 1998

<sup>13</sup> Pennsylvania Handbook of Best Management Practices for Developing Areas, Prepared by CH2MHILL, Spring 1998



sediments. This layer should be single or double shredded hardwood mulch or chips, a maximum of three inches deep, and well aged (12 months).<sup>14</sup>

6) native plant material -- established in a random and natural pattern.<sup>15</sup>

Bioretention facilities are most effective if they receive runoff close to the source. A site designer should look for opportunities to incorporate bioretention facilities throughout the site and thereby minimize the need for and use of inlets, pipes, and downstream controls.<sup>16</sup>

**Bioretention Facilities Reduce Stormwater Runoff:** "Prince George's County, MD, which initially developed the bioretention concept, reports savings as much as 50 percent on drainage infrastructure costs in developments that incorporate bioretention facilities."<sup>17</sup> Beltway Plaza, a busy mall in Prince George's County, for instance, has used the bioretention filter successfully for years and has had so many positive comments from shoppers and managers that they have expanded the use of the landscaping on the property.<sup>18</sup>

**Bioretention Facilities Save Money:** The benefits of the Prince George's County filter are: mall owner and manager get a more desirable shopping destination with no additional maintenance costs (about \$200/year — the same as a grassed median); mall customers get a more beautiful and shady place to park; and the local streams get a partial break from polluted, "flashy" runoff flows.<sup>19</sup>

**Bioretention Facilities Improve Water Quality:** The University of Maryland recently studied the performance of the Beltway Plaza bioretention filter and found: 97% of the copper; approximately 95% of lead and zinc; 65% of the total phosphorous; 52% of the Kjeldahl nitrogen were removed.<sup>20</sup>

### Design considerations

✓ Bioretention facilities should not be used where the water table is within 6 feet of the land surface, mature trees would have to be removed to construct the facility, slopes are 20% or greater, or there is an unstable soil stratum in the proximity.<sup>21</sup>

✓ If a bioretention facility is used in areas between 1 and 10 acres, diversion structures and energy dissipaters should be used to preserve the integrity of the bioretention area.

---

<sup>14</sup> Pennsylvania Handbook of Best Management Practices for Developing Areas, Prepared by CH2MHILL, Spring 1998; 2000 Maryland Stormwater Design Manual, MDE, Volume I, draft, 1999, page A-12, 13, 14

<sup>15</sup> Pennsylvania Handbook of Best Management Practices for Developing Areas, Prepared by CH2MHILL, Spring 1998; 2000 Maryland Stormwater Design Manual, MDE, Volume I, draft, 1999, page A-12, 13, 14

<sup>16</sup> Pennsylvania Handbook of Best Management Practices for Developing Areas, Prepared by CH2MHILL, Spring 1998

<sup>17</sup> Pennsylvania Handbook of Best Management Practices for Developing Areas, Prepared by CH2MHILL, Spring 1998

<sup>18</sup> Prince George's County DER, MD, from NRDC, *Stormwater Strategies*, 1999

<sup>19</sup> Prince George's County DER, MD, from NRDC, *Stormwater Strategies*, 1999

<sup>20</sup> Prince George's County DER, MD, from NRDC, *Stormwater Strategies*, 1999

<sup>21</sup> Pennsylvania Handbook of Best Management Practices for Developing Areas, Prepared by CH2MHILL, Spring 1998



✓ On line bioretention facilities can use check dams to collect the water. Having a bioretention area "behind a check dam allows filtering and trapping of sediment."<sup>22</sup>

✓ For offline systems, Prince George's County recommends "using planting soil ranging from 10 to 25 percent clay along with sandy loam, loamy sand, or loam texture."<sup>23</sup> "In areas where clay contents are higher and the soil is not conducive to infiltration, the bioretention facility can be modified with a collector pipe system installed beneath the basin to form a bioretention filter."<sup>24</sup>

✓ Plants are intended to replicate a terrestrial forest community of native species. Therefore native trees, shrubs and herbaceous plants should be included in defined layers, with trees dominating. The planting should be dense and diverse.<sup>25</sup>

---

<sup>22</sup> Pennsylvania Handbook of Best Management Practices for Developing Areas, Prepared by CH2MHILL, Spring 1998

<sup>23</sup> Pennsylvania Handbook of Best Management Practices for Developing Areas, Prepared by CH2MHILL, Spring 1998

<sup>24</sup> Pennsylvania Handbook of Best Management Practices for Developing Areas, Prepared by CH2MHILL, Spring 1998

<sup>25</sup> Pennsylvania Handbook of Best Management Practices for Developing Areas, Prepared by CH2MHILL, Spring 1998; 2000 Maryland Stormwater Design Manual, MDE, Volume I, draft, 1999, page A-12, 13, 14



## Fact Sheet -- Stormwater Runoff, the Lost Resource Grassed Drainage Swales

Grassed swales are long, shallow depressions designed to intercept sheet flow from surrounding lands and to provide for as much detention and/or infiltration as possible while the run-off is being conveyed through the swale from one part of a site to another. Conventional stormwater conveyance and piping systems provide no water quality benefits, no infiltration benefits and actually worsen the velocities and erosive forces of stormwater runoff. By contrast, vegetated swales slow stormwater flows, capture some pollutants, and can allow an opportunity for infiltration.<sup>1</sup> Therefore, to the extent possible, developers should rely on open vegetated drainage swales and filter strips as an alternative to enclosed storm sewers or lined channels.

**Definition:** Vegetated filter strip -- a strip of permanent vegetation that receives runoff in the form of sheet flow from impervious areas and provides protection to waterways or stormwater management facilities. Vegetation can range from grass to forest.

*2000 Maryland Stormwater Design Manual,  
MDE, Volume I, draft, 1999*

### Grassed Swales Reduce Volume and Peak Flow of Runoff

If properly designed, vegetated swales can provide significant water quantity and quality benefits and may reduce the size of, or even eliminate the need for, elaborate stormwater treatment structures.<sup>2</sup> It has been found that these swales give a "surprising degree" of volume reduction in terms of both total volume and peak rate discharge. This is most pronounced for the smaller, more frequent storms.<sup>3</sup> "By reducing flow velocities and increasing a site's time of concentration, grass swales will contribute to reducing the runoff peaks."<sup>4</sup> Even in storms where swales are not enough to achieve peak rate and total volume objectives, they still provide substantial quantity benefits "sufficient to reduce the typical flashiness of urbanizing streams"<sup>5</sup> and to reduce the peak and volume of runoff that must

**Definition:** Time of concentration -- "time required for water to flow from the most remote point of a watershed [or site], in a hydraulic sense, to the outlet [or waterway]"

*2000 Maryland Stormwater Design Manual,  
MDE, Volume I, glossary, draft, 1999.*

<sup>1</sup> DNREC and Brandywine Conservancy, Conservation Design for Stormwater Management: A Design Approach to Reduce Stormwater Impacts from Land Development and Achieve Multiple Objectives Related to Land Use, September, 1997, p. 3-58

<sup>2</sup> DNREC and Brandywine Conservancy, Conservation Design for Stormwater Management: A Design Approach to Reduce Stormwater Impacts from Land Development and Achieve Multiple Objectives Related to Land Use, September, 1997, p. 3-58

<sup>3</sup> DNREC and Brandywine Conservancy, Conservation Design for Stormwater Management: A Design Approach to Reduce Stormwater Impacts from Land Development and Achieve Multiple Objectives Related to Land Use, September, 1997, p. 3-61

<sup>4</sup> Pennsylvania Handbook of Best Management Practices for Developing Areas, Prepared by CH2MHILL, Spring 1998

<sup>5</sup> DNREC and Brandywine Conservancy, Conservation Design for Stormwater Management: A Design Approach to Reduce Stormwater Impacts from Land Development and Achieve Multiple Objectives Related to Land Use, September, 1997, p. 3-62



otherwise be addressed by other stormwater management systems.

✓ Grassed swales can reduce peak runoff rates and increase opportunities for infiltration. A portion of the runoff infiltrates into the soil as it passes through the swale thereby reducing volume of runoff and contributing to peak reduction.<sup>6</sup> Vegetated swales have been found to reduce storm runoff volumes by up to 15 percent.<sup>7</sup> The amount of infiltration can be limited, but small check dams can increase the performance.<sup>8</sup>

✓ By lengthening the flow path and increasing resistance beyond that of a more conventional stormwater conveyance system such as storm sewers, vegetated swales reduce flow rates and delay the timing of runoff thereby lengthening the time of concentration.<sup>9</sup> Swales can lengthen the time of concentration on a site as well as in the watershed and they can reduce peak rates.<sup>10</sup>

### **Grassed Swales Improve Water Quality**

Grassed swales can have water quality benefits: (1) grass blades have a “scrub brush” effect, trapping and stabilizing sediment; (2) the ability of the grass to grow up through sediment, growing longer as stems become covered, prevents the sediment from being re-suspended and washed out of the swale;<sup>11</sup> (3) slowing stormwater's travel over the vegetation allows dissolved pollutants to be taken up by vegetation and infiltration of stormwater allows heavy metals, (including lead, copper, zinc) and nutrient pollution to be removed.<sup>12</sup>

Where appropriate, grassed swales and open channels can be used to convey stormwater along roadways, on highway medians, or in recessed areas in parking lots. This provides an opportunity for infiltration as well as providing water quality benefits.

Use of a grassed swale eliminates curbing. The lack of a curb eliminates a major trap of airborne pollutants that then are not deposited into stream-bound stormwater runoff.<sup>13</sup> The

---

<sup>6</sup> Northeastern Illinois Planning Commission, "Reducing the Impacts of Urban Runoff: The Advantages of Alternative Site Design Approaches", April, 1997

<sup>7</sup> Northeastern Illinois Planning Commission, "Reducing the Impacts of Urban Runoff: The Advantages of Alternative Site Design Approaches", April, 1997

<sup>8</sup> Pennsylvania Handbook of Best Management Practices for Developing Areas, Prepared by CH2MHILL, Spring 1998; New York State Department of Environmental Conservation, Reducing the Impacts of Stormwater Runoff from New Development, April, 1992

<sup>9</sup> DNREC and Brandywine Conservancy, Conservation Design for Stormwater Management: A Design Approach to Reduce Stormwater Impacts from Land Development and Achieve Multiple Objectives Related to Land Use, September, 1997, p. 4-27

<sup>10</sup> DNREC and Brandywine Conservancy, Conservation Design for Stormwater Management: A Design Approach to Reduce Stormwater Impacts from Land Development and Achieve Multiple Objectives Related to Land Use, September, 1997, p. 3-58

<sup>11</sup> "Biofiltration Swale Performance, Recommendations, and Design Considerations", Municipality of Metropolitan Seattle, WA, Aug. 1, 1993

<sup>12</sup> DNREC and Brandywine Conservancy, Conservation Design for Stormwater Management: A Design Approach to Reduce Stormwater Impacts from Land Development and Achieve Multiple Objectives Related to Land Use, September, 1997, p. 3-62

<sup>13</sup> Center for Watershed Protection, Site Planning for Urban Stream Protection, co-published by the Metropolitan Washington Council of Governments, December 1995



traditional curb, gutter, storm drain inlet and storm drainpipe systems cost 2 to 3 times more than the swale approach.<sup>14</sup>

### Types of Swales

An **open grassed channel** can be used to infiltrate stormwater through a soil bed of permeable soils or to catch runoff for pretreatment before it enters a pond, wetland, or filter system. It is designed to have enough capacity to convey large storm events (i.e. ten-year storm) and captures coarse sediment before it moves downstream.

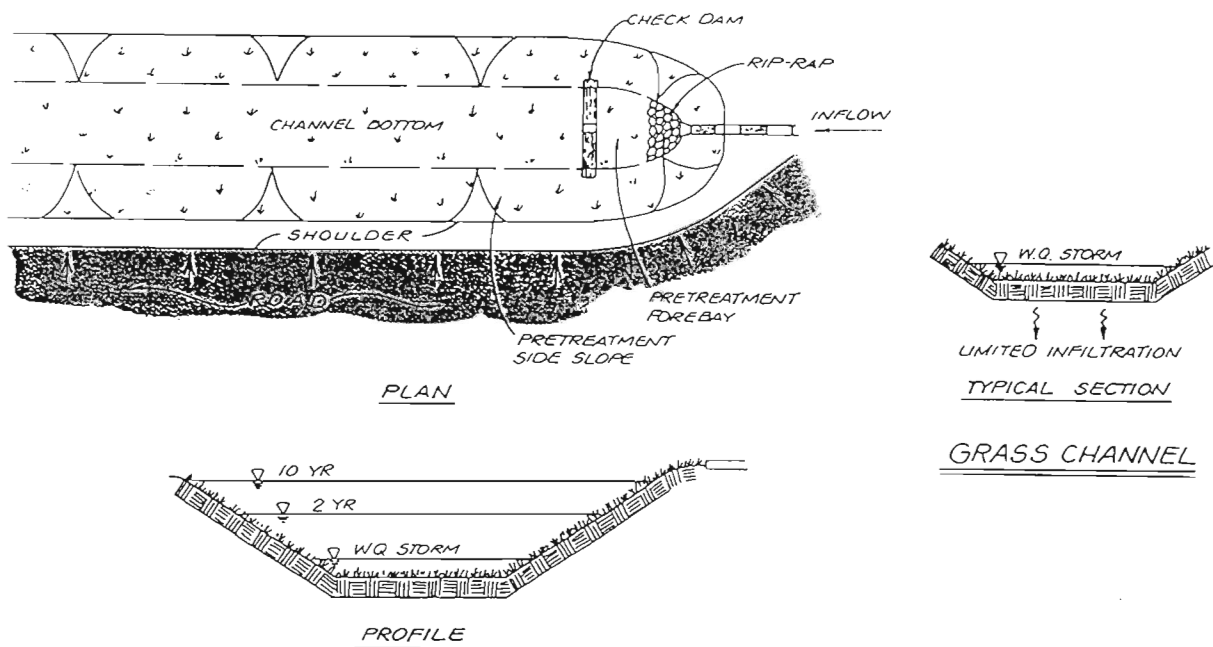

### Grassed Channel

*Site Planning for Urban Stream Protection, by the Center for Watershed Protection, co-published by the Metropolitan Washington Council of Governments, December 1995*

<sup>14</sup> Center for Watershed Protection, *Better Site Design: A Handbook for Changing Development Rules in Your Community*, August, 1998, p. 158





**Dry swales** capture the runoff volume from the water quality storm event and filter it through 30 inches of soil before it is collected by an underdrain. These need protection or pre-treatment such as a checkdam or gravel filter. They need to rapidly de-water so amended soils with greater permeability are often required.<sup>15</sup> Along the length of a grassed swale, checkdams or excavated depressions can be installed to improve infiltration.<sup>16</sup>

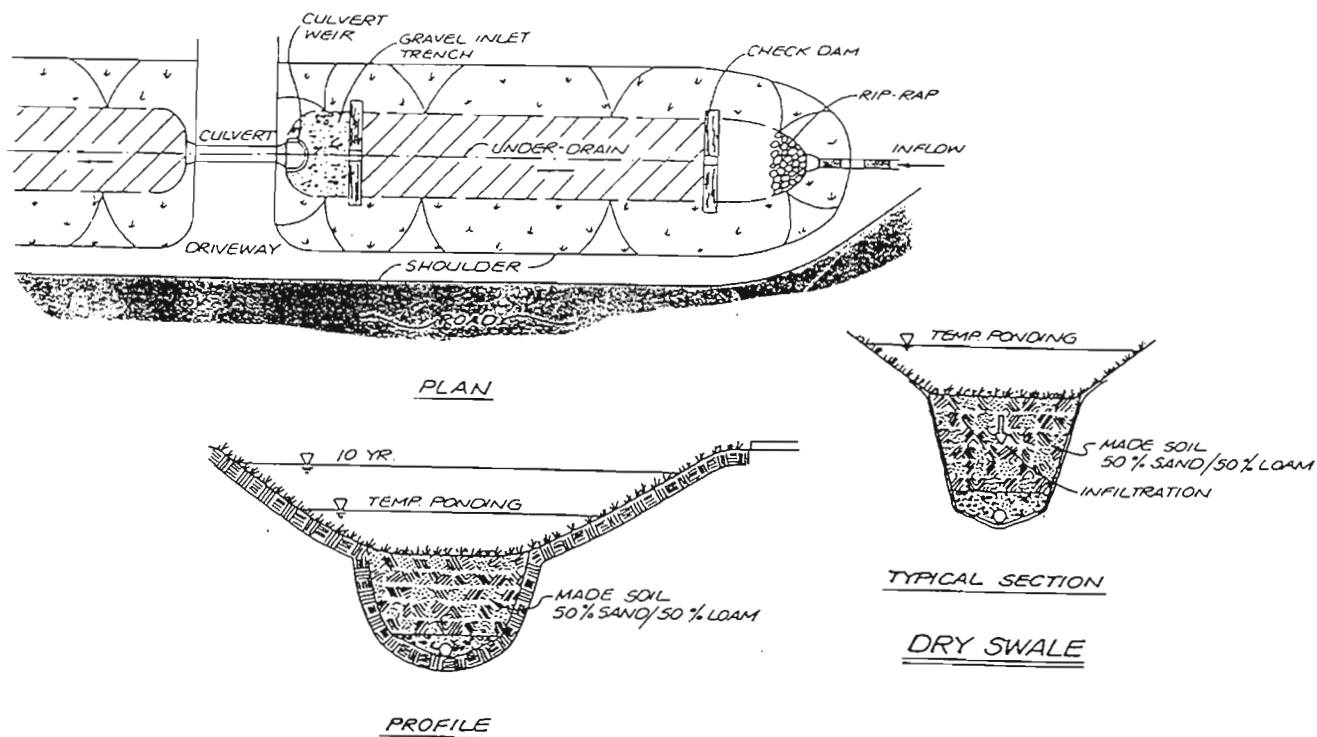

### Dry Swale

*Site Planning for Urban Stream Protection, by the Center for Watershed Protection, co-published by the Metropolitan Washington Council of Governments, December 1995*

<sup>15</sup> Center for Watershed Protection, Site Planning for Urban Stream Protection, co-published by the Metropolitan Washington Council of Governments, December 1995

<sup>16</sup> DNREC and Brandywine Conservancy, Conservation Design for Stormwater Management: A Design Approach to Reduce Stormwater Impacts from Land Development and Achieve Multiple Objectives Related to Land Use, September, 1997, p. 3-59; Protecting Natural Wetlands. A Guide to Stormwater Best Management Practices, USEPA #843-B-96-001, October 1996, p. 4-28



If the water table is very near the surface and it is likely that soils will be saturated most of the year, then a **wet swale** should be used. The swale then acts like a long pocket wetland and should be planted with wetland plants to provide additional water quality benefits.<sup>17</sup> Due to standing water, this is usually only appropriate for large lot rural settings, campus type office complexes (with a low amount of impervious surface) or for streets that don't front onto houses.<sup>18</sup>

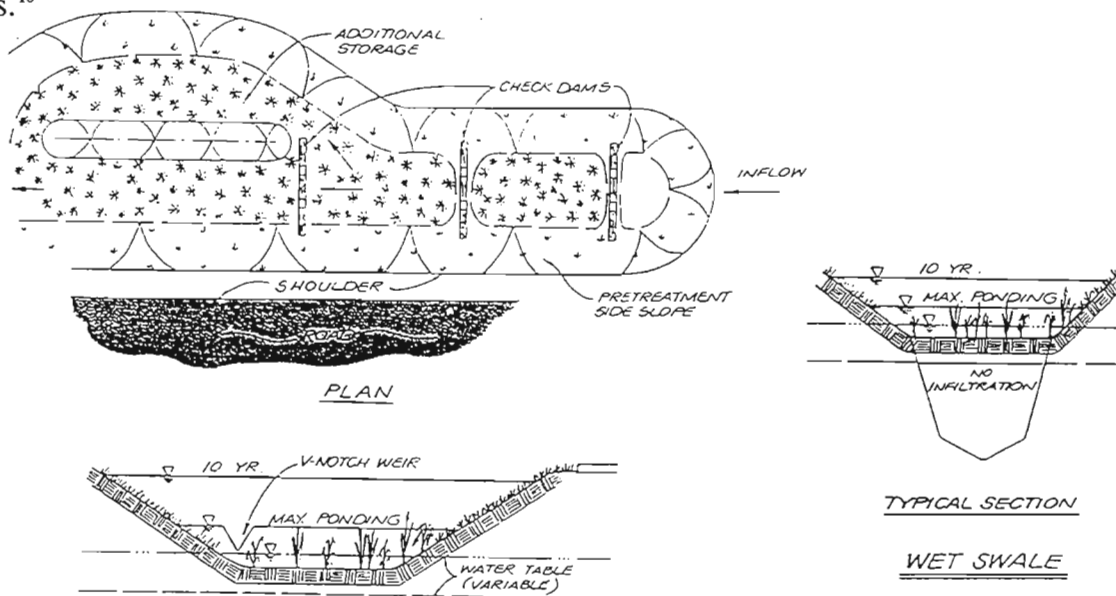

PROFILE **Wet Swale**

*Site Planning for Urban Stream Protection, by the Center for Watershed Protection, co-published by the Metropolitan Washington Council of Governments, December 1995*

### Design Considerations

✓ The slope in the flow of the swale should be less than 2% and the swale should be wide and shallow, with a hyperbolic shape. The sides of the slope should be less than 3:1.<sup>19</sup>

✓ Grasses in the swale must be tough, non-invasive, and preferably native and should not be mowed short. Use of pesticides and fertilizers should be avoided. A planting bed of shrubs or trees on the east or north side of the swale can be used to stabilize the soil above the swale. It is important, however, that trees do not shade the swale excessively or drop excessive leaves or needles that cause debris jams or smother the grass. Moss can be allowed to grow with the grass in shady areas, as long as the grass density is high enough--the swale should not be so shaded that the moss outgrows the grass, which would lose the swale's "scrub brush effect".<sup>20</sup>

<sup>17</sup> DNREC and Brandywine Conservancy, Conservation Design for Stormwater Management: A Design Approach to Reduce Stormwater Impacts from Land Development and Achieve Multiple Objectives Related to Land Use, September, 1997, p. 3-58

<sup>18</sup> Center for Watershed Protection, Site Planning for Urban Stream Protection, co-published by the Metropolitan Washington Council of Governments, December 1995

<sup>19</sup> Protecting Natural Wetlands. A Guide to Stormwater Best Management Practices, USEPA #843-B-96-001, October 1996, p. 4-28

<sup>20</sup> Pennsylvania Handbook of Best Management Practices for Developing Areas, Prepared by CH2MHILL, Spring 1998



✓ Underlying soils should have a percolation rate of at least 0.5 inches per hour.<sup>21</sup> Where possible, natural drainage ways on the site should be used as part of the swale drainage system.<sup>22</sup> Only lightweight equipment should be used during installation to avoid soil compaction and to protect percolation capability.

✓ When directing water to a drainage infrastructure, traditionally a straight path is created. The result is that the flow path the water travels on is decreased and the flow of the water is accelerated. This approach strengthens the water's ability to scour downstream receiving systems. By comparison, using a meandering flow path dissipates the water's energy, thereby reducing its erosion potential.<sup>23</sup>

### **Maintenance**

Maintenance requirements are relatively minimal and costs are low. The most important maintenance task is to keep the vegetation dense and vigorous. Sediment and debris removal from behind check dams and/or depressions is needed. Since grass should be kept long, mowing is done only occasionally. Cuttings should be removed immediately.

### **Ways to increase swale efficiency:**

- ✓ Check dams
- ✓ Low slopes
- ✓ Permeable subsoils
- ✓ Dense grass cover
- ✓ Long contact time; meandering flow path
- ✓ Higher vegetation height
- ✓ Coupling swales with plunge pools, infiltration trenches or pocket wetlands
- ✓ Swale length greater than 200 feet

### **Ways to decrease swale efficiency:**

- ✓ Compacted subsoils
- ✓ Short runoff contact time
- ✓ Short grass heights
- ✓ Steep slopes (6% or greater)
- ✓ Runoff velocities (1.5 ft/sec or more)
- ✓ Peak discharge (5 cu.ft/sec or more)
- ✓ Dry weather flow or drought conditions that compromise the vegetation

*DNREC and Brandywine Conservancy,  
"Conservation Design for Stormwater  
Management; A Design Approach to Reduce  
Stormwater Impacts from Land Development and  
Achieve Multiple Objectives Related to Land Use",  
September, 1997, p. 3-63;  
Protecting Natural Wetlands, A Guide to Stormwater  
Best Management Practices,  
USEPA #843-B-96-001. October 1996. n. 4-28*

<sup>21</sup> New York State Department of Environmental Conservation, Reducing the Impacts of Stormwater Runoff from New Development, April, 1992; "Biofiltration Swale Performance, Recommendations, and Design Considerations", Municipality of Metropolitan Seattle, WA, 8.1.93

<sup>22</sup> Pennsylvania Handbook of Best Management Practices for Developing Areas, Prepared by CH2MHILL, Spring 1998

<sup>23</sup> DNREC and Brandywine Conservancy, Conservation Design for Stormwater Management: A Design Approach to Reduce Stormwater Impacts from Land Development and Achieve Multiple Objectives Related to Land Use, September, 1997, p. 2-31



## Fact Sheet -- Stormwater Runoff, the Lost Resource Infiltration Trenches

One very effective means of capturing and infiltrating stormwater is building a trench around the source of stormwater.

An infiltration trench is a stone-filled subsurface trench, generally 2 to 10 ft. in length, but is sized based on the volume of runoff entering it.<sup>1</sup> Stormwater is collected and percolates slowly into the soil from the trench. There is generally no outlet although they can be used to convey water to a stormwater detention system. The trench can be placed in a wooded area without much disturbance of the forest and can add infiltration opportunity when an area outside the woods has been disturbed. Infiltration trenches can also be effectively used in terrace fashion on slopes.<sup>2</sup>

Using an infiltration trench, stormwater is treated as it moves through the soil. An infiltration trench can protect water quality by removing fine particulate and soluble pollutants through adsorption and microbial decomposition in the soil.<sup>3</sup>

It is a good idea to pretreat runoff before it reaches the infiltration trench to prevent particulates from building up and inhibiting future function. Passage of runoff through a grassed swale or vegetated filter strip allows coarse particulates to be removed prior to entering the trench.<sup>4</sup> This vegetated buffer can also improve the aesthetic appeal of an infiltration trench.

By infiltrating runoff through the soil, infiltration trenches reduce both the volume of runoff and peak flows. The reduction in peak flow and volume of runoff can reduce downstream flooding and streambank erosion and enhances groundwater recharge.<sup>5</sup> How efficient they are depends on the degree of storage and exfiltration achieved through trench design.<sup>6</sup> Even if the trench

**Definition:** Exfiltration --  
"the downward flow of runoff  
from the bottom of an  
infiltration BMP into the soil"

*2000 Maryland Stormwater Design  
Manual, MDE, Volume I, glossary,  
draft, 1999.*

<sup>1</sup> Pennsylvania Handbook of Best Management Practices for Developing Areas, Prepared by CH2MHILL, Spring 1998; New York State Department of Environmental Conservation, Reducing the Impacts of Stormwater Runoff from New Development, April, 1992; Protecting Natural Wetlands, A Guide to Stormwater Best Management Practices, USEPA #843-B-96-001, October 1996, p. 4-27

<sup>2</sup> Pennsylvania Handbook of Best Management Practices for Developing Areas, Prepared by CH2MHILL, Spring 1998; New York State Department of Environmental Conservation, Reducing the Impacts of Stormwater Runoff from New Development, April, 1992

<sup>3</sup> Protecting Natural Wetlands, A Guide to Stormwater Best Management Practices, USEPA #843-B-96-001, October 1996, p. 4-26

<sup>4</sup> Protecting Natural Wetlands, A Guide to Stormwater Best Management Practices, USEPA #843-B-96-001, October 1996, p. 4-26

<sup>5</sup> Protecting Natural Wetlands, A Guide to Stormwater Best Management Practices, USEPA #843-B-96-001, October 1996, p. 4-25

<sup>6</sup> New York State Department of Environmental Conservation, Reducing the Impacts of Stormwater Runoff from New Development, April, 1992



cannot individually meet peak flow requirements, it reduces the volume and peak rate of runoff that would otherwise need to be accommodated by other stormwater management approaches, while enhancing water quality and aquifer recharge on a site.

### **Design Considerations**

- ✓ Maintenance and prevention of sediment accumulation in the trench must be strictly controlled during construction and use. A filter strip or grass protecting the infiltration trench will trap sediment, particulates and litter before it washes into the trench thereby helping to ensure its continued effectiveness and improving its longevity.<sup>7</sup>
- ✓ Detention time of 48 to 72 hours will maximize removal of pollutants. The trench should drain after a maximum of 72 hours so that aerobic conditions are maintained.<sup>8</sup>
- ✓ Trenches should not be located next to wetlands or a shallow groundwater table unless it can be designed so that no pollutants are delivered to the wetlands or groundwater. Also, the hydroperiod impacts should be considered.<sup>9</sup>
- ✓ There shouldn't be any vehicular traffic or foot traffic over infiltration trenches to avoid compacting the aggregate material.
- ✓ A monitoring well, made of 4 to 6 inch diameter PVC pipe, can be put into the design for ease of inspection.<sup>10</sup>
- ✓ Infiltration trenches are primarily an on-site control treating water from areas no larger than 5 to 10 acres. Trenches treating over 10 acres should be designed to accommodate overflow because this will likely happen at some point. The larger trenches tend not to be economical or practical.<sup>11</sup>
- ✓ Bottom of trench should be level.<sup>12</sup>
- ✓ Contributing slopes should be less than 5%.<sup>13</sup>

---

<sup>7</sup> Pennsylvania Handbook of Best Management Practices for Developing Areas, Prepared by CH2MHILL, Spring 1998

<sup>8</sup> Protecting Natural Wetlands, A Guide to Stormwater Best Management Practices, USEPA #843-B-96-001, October 1996, p. 4-26

<sup>9</sup> Protecting Natural Wetlands, A Guide to Stormwater Best Management Practices, USEPA #843-B-96-001, October 1996, p. 4-26

<sup>10</sup> Pennsylvania Handbook of Best Management Practices for Developing Areas, Prepared by CH2MHILL, Spring 1998

<sup>11</sup> Pennsylvania Handbook of Best Management Practices for Developing Areas, Prepared by CH2MHILL, Spring 1998; New York State Department of Environmental Conservation, Reducing the Impacts of Stormwater Runoff from New Development, April, 1992

<sup>12</sup> Protecting Natural Wetlands, A Guide to Stormwater Best Management Practices, USEPA #843-B-96-001, October 1996, p. 4-2

<sup>13</sup> Protecting Natural Wetlands, A Guide to Stormwater Best Management Practices, USEPA #843-B-96-001, October 1996, p. 4-26



✓ Infiltration trenches are generally used with soils or soil amendments with an infiltration rate of greater than 0.5 inches/hour and it is recommended that the bottom be 3 to 4 feet higher than the seasonal high water table or bedrock.<sup>14</sup>

✓ Infiltration trenches must be inspected regularly to ensure control of sediment accumulation.

### Maintenance:

Periodic low level maintenance is needed, including routine inspection for drainage and checking of the inspection port. Routine vegetation repair and/or mowing of buffers are needed. Leaves should not be allowed to clog the trench. Trees should not be allowed to invade the trench area.<sup>15</sup>

The surface of the trench area and/or the inlet, if one exists, should be checked for sediment buildup and clogging. Sediment may need to be removed. If filter fabric has been used to cover the aggregate (which prolongs the life of the system), it can be removed and washed every few years or as needed. A pre-treatment medium, such as a grassed swale, reduces sediment buildup. The pre-treatment medium should be cleaned out periodically.<sup>16</sup>

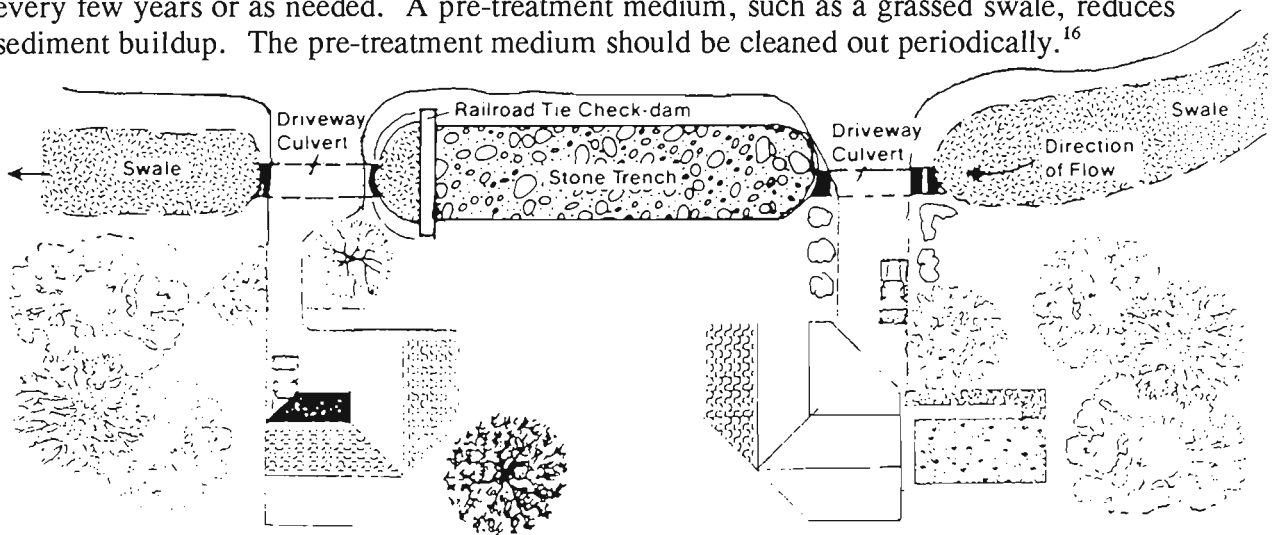

### Infiltration Trench Schematic

*Cahill Associates for the State of New Jersey, NJDEP, Division of Coastal Resources, Stormwater Management and the New Jersey Coastal Zone, April 1989, adapting Schueler, 1987.*

<sup>14</sup> Protecting Natural Wetlands. A Guide to Stormwater Best Management Practices, USEPA #843-B-96-001, October 1996, p. 4-26; Pennsylvania Handbook of Best Management Practices for Developing Areas, Prepared by CH2MHILL, Spring 1998

<sup>15</sup> Protecting Natural Wetlands. A Guide to Stormwater Best Management Practices, USEPA #843-B-96-001, October 1996, p. 4-28

<sup>16</sup> Protecting Natural Wetlands. A Guide to Stormwater Best Management Practices, USEPA #843-B-96-001, October 1996, p. 4-28



## Fact Sheet -- Stormwater Runoff, the Lost Resource Porous Paving

Porous paving is a conventional bituminous (asphalt) paving mixture but the fine particles have been kept to a minimum in order to maintain invisible, small openings through which rain water can penetrate. Beneath the porous paving is a recharge bed filled with crushed stone. The stone is all of uniform size and provides a storage capacity in the 40% void space of the stone bed.<sup>1</sup> Water flows through the porous paving to the recharge bed below where it is stored until it can gradually percolate into the soil and underlying aquifers. The rate of outflow/infiltration is dependent on the properties of the soil mantle.<sup>2</sup> A special filter fabric that allows infiltration of water to the soil, lines the bed to prevent soil and sediment from entering the recharge bed and reducing its holding capacity.<sup>3</sup>

Porous paving with an underground recharge bed is an effective method of capturing and infiltrating stormwater. Porous paving projects have been found to have a long life. Projects put in place 18 years ago, such as that installed by Cahill Associates at Shared Medical Systems in Malvern, PA, still function effectively in all rain events, including recent hurricanes. Over two dozen porous paving projects have been installed in Pennsylvania, New Jersey and Delaware and continue to function as engineered and designed. They have not required repair or replacement work to date and there are no signs of decay.<sup>4</sup> Even a standard bituminous pavement generally requires repair in a 5-year time span.<sup>5</sup> Therefore, on comparison, porous paving holds up very well. At a minimum, porous paving is as durable as conventional paving.<sup>6</sup>

"Properly installed and maintained [porous bituminous] pavements can be expected to function effectively for 20 years or more...."

Pennsylvania Handbook of Best Management Practices for Developing Areas, Prepared by CH2MHILL, Spring 1998

If conventional bituminous is required on a site because of personal preference or other specific needs it can be effectively coupled with the recharge bed concept and provide equal infiltration capabilities. In such cases, conventional pavement is placed over the recharge bed with a system of inlets draining stormwater into the underlying recharge bed, where it is held until infiltrated.<sup>7</sup> Providing a perimeter into which runoff can be captured and channeled into the recharge bed below is one very effective approach, as are similar inlets around intermediate

<sup>1</sup> Cahill Associates, "Stormwater Management Systems, Porous Pavement System with Underground Recharge Beds, Engineering Design Report, Spring, 1993

<sup>2</sup> Cahill Associates, "Stormwater Management Systems, Porous Pavement System with Underground Recharge Beds, Engineering Design Report", Spring, 1993

<sup>3</sup> Cahill Associates, "Stormwater Management Systems, Porous Pavement System with Underground Recharge Beds, Engineering Design Report", Spring, 1993

<sup>4</sup> Cahill Associates, "Stormwater Management Systems, Porous Pavement System with Underground Recharge Beds, Engineering Design Report", Spring, 1993

<sup>5</sup> Personal communication with Tom Cahill, P.E., Cahill Associates, August 29, 2000

<sup>6</sup> Bruce K. Ferguson, Stormwater Infiltration, CRC Press, 1994, p. 42

<sup>7</sup> Cahill Associates, "Stormwater Management Systems, Porous Pavement System with Underground Recharge Beds, Engineering Design Report", Spring, 1993





islands.<sup>8</sup> Experts using these techniques have actually found that a combination of approaches is preferable -- a porous paving bituminous, over a recharge bed, with a system of inlets. The inlets provide an alternative path to the recharge bed should the need arise (for example, a maintenance person covering the pavement with a sealant thereby destroying the porosity of the paving).<sup>9</sup>

***Recommended Reading:***

*Stormwater Management Systems, Porous Pavement System with Underground Recharge Beds, Engineering Design Report, Cahill Associates, Spring, 1993*

**Porous Paving with Recharge Technology Can Save Money**

Porous paving projects are generally found to cost the same as or less than conventional approaches such as a detention basin.<sup>10</sup> While porous paving installation and maintenance costs approximately 10% more than traditional bituminous paving, savings in the storm drain system including detention basin, inlets, and underground piping, which is needed for traditional impervious paving, results in a total cost savings of between 12 to 38%.<sup>11</sup> And when the cost of additional land which would otherwise be necessary for a detention basin or similar system is included in the calculations, porous paving with recharge costs significantly less.<sup>12</sup> It has been reported that maintenance costs for porous paving are cheaper than any other BMP on commercial sites.<sup>13</sup>

In this region:  
 A **1-year storm event** is 2.5 inches of rainfall within 24 hours.  
 A **2-year storm event** is 3.2 inches within 24 hours.

*Stormwater Management Systems, Porous Pavement System with Underground Recharge Beds, Engineering Design Report, Cahill Associates, Spring, 1993*

**Porous Paving with Recharge Technology Reduces Volume of Runoff and Peak Rate**

Porous paving with recharge bed technology can be designed to provide protection for both the 2-year storm and the 100-year storm, accommodating the needs of both events. Experts have found that designing the recharge beds to recharge the development-induced runoff from a 2-year storm event usually also satisfies the criteria for handling the 100-year peak rate criterion required by many communities.<sup>14</sup> In fact, in some instances, porous paving projects have been found to reduce the post-development runoff rate to less than the pre-development rate -- in other words more water was recharged after the development with

<sup>8</sup> Cahill Associates, "Stormwater Management Systems, Porous Pavement System with Underground Recharge Beds, Engineering Design Report", Spring, 1993

<sup>9</sup> Cahill Associates, "Stormwater Management Systems, Porous Pavement System with Underground Recharge Beds, Engineering Design Report", Spring, 1993

<sup>10</sup> Personal communication with Tom Cahill, P.E., Cahill Associates, August 29, 2000

<sup>11</sup> Bruce K. Ferguson, *Stormwater Infiltration*, CRC Press, 1994, p. 41

<sup>12</sup> Cahill, Adams, Horner, Cahill and Associates, "The Use of Porous Paving for Groundwater Recharge in Stormwater Management Systems", October 1988

<sup>13</sup> Cahill, Adams, Horner, Cahill and Associates, "The Use of Porous Paving for Groundwater Recharge in Stormwater Management Systems", October 1988

<sup>14</sup> Cahill Associates, "Stormwater Management Systems, Porous Pavement System with Underground Recharge Beds, Engineering Design Report", Spring, 1993



porous paving project was built than before the site was disturbed.<sup>15</sup> This has the added benefit of mitigating impacts inflicted on a watershed by other existing development projects.

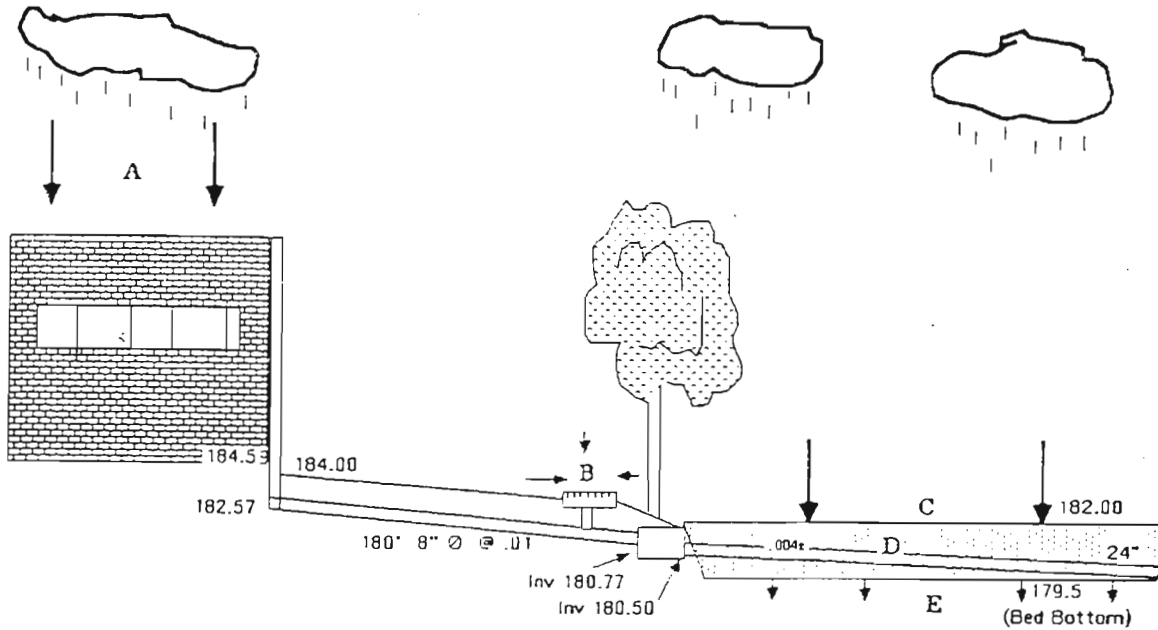

- A. Precipitation is carried from roof by roof drains to storage beds.
- B. Stormwater runoff from impervious areas and lawn areas is carried to storage beds.
- C. Precipitation that falls on pervious paving enters storage beds directly.
- D. Stone beds with 40% void space store water.  
Continuously perforated pipes distribute stormwater from impervious surfaces evenly throughout the beds.
- E. Stormwater exfiltrates from storage beds and into soil, recharging groundwater.

**Porous pavement beds can infiltrate multiple stormwater inputs.**

*Cahill, Adams, Horner, The Use of Porous Paving for Groundwater Recharge in Stormwater Management Systems, Cahill and Associates, October 1988*

If a porous paving project cannot be built that fully accommodates the 1 or 2-year storm, a small project still can be an important part of the stormwater management effort carried out on a site. For example, a project designed to handle only the 1-inch in 24-hour event can still infiltrate a significant amount of the annual rainfall because these small storms are so frequent.<sup>16</sup> The result is less runoff that needs to be managed by other systems, as well as recharge benefits to the underlying aquifer and dependent stream systems.

"Porous pavement with underground recharge bed technology can be designed to receive runoff from an area substantially greater than the beds themselves."<sup>17</sup> In a number of

<sup>15</sup> Cahill Associates, "Stormwater Management Systems, Porous Pavement System with Underground Recharge Beds, Engineering Design Report", Spring, 1993, p. 20.

<sup>16</sup> Cahill Associates, "Stormwater Management Systems, Porous Pavement System with Underground Recharge Beds, Engineering Design Report", Spring, 1993

<sup>17</sup> Cahill Associates, "Stormwater Management Systems, Porous Pavement System with Underground Recharge Beds, Engineering Design Report", Spring, 1993, p. 18.



instances, runoff from other areas on a site, such as rooftops and lawns, have been redirected to enter these recharge beds for infiltration. Depending on the design storm and other factors, porous paving projects can be designed to recharge either all of the stormwater runoff from a site or a portion of the runoff, the rest being handled by either infiltration and/or detention systems.<sup>18</sup>

### **Porous Paving with Recharge Technology Improves Water Quality**

Porous paving with recharge technology provides water quality benefits. As a storm event begins, it is the first wash over the land surface ("first flush") that carries most of the pollutants. When directed to an infiltration system such as a porous paving recharge bed, many of these pollutants will be filtered out and never reach the local waterway. On sites where porous paving is supplemented by other stormwater systems, by the time the other systems on the site kick in (such as detention systems) the significant pollution load of the "first flush" has already been removed.<sup>19</sup>

**Pollutants delivered from roadways and parking lots include:** vehicle emissions, sediment, phosphorous, copper, cadmium, zinc, coliform bacteria, air deposition, pavement deterioration, tire and brake pad wear, pet waste, lawn runoff.

### **Other Benefits of Porous Paving with Recharge**

Porous paving has other benefits beyond its stormwater water quality and quantity benefits.<sup>20</sup>

- ✓ Recharges groundwater aquifers;
- ✓ Allows preservation of site features such as wetlands and woodlands that would normally be lost to a detention basin;
- ✓ It is more skid resistant when wet;
- ✓ Curbs and gutters are not needed for primary drainage control;
- ✓ Painted markings are more visible when it is rainy;
- ✓ Slightly reduces vehicle noise level;
- ✓ It may reduce the demand for de-icing salts;
- ✓ Damage caused by snow removal equipment is less than to other types of pavement;
- ✓ The drainage properties of porous bituminous minimize icing problems;
- ✓ After a thaw, you do not have standing water that will refreeze to ice;
- ✓ Puddles are virtually non-existent.

### **Frequent Misconceptions About Porous Paving**

- ✓ "Pavement quickly becomes clogged and no longer functions"<sup>21</sup>

Using proper design and maintenance protocols ensures that clogging is not a problem. Porous paving projects throughout the region -- including Shared Medical Services in Malvern, PA,

<sup>18</sup> Cahill Associates, "Stormwater Management Systems, Porous Pavement System with Underground Recharge Beds, Engineering Design Report", Spring, 1993

<sup>19</sup> Cahill Associates, "Stormwater Management Systems, Porous Pavement System with Underground Recharge Beds, Engineering Design Report", Spring, 1993, p. 21, also citing Scholar, 1985.

<sup>20</sup> Bruce K. Ferguson, *Stormwater Infiltration*, CRC Press, 1994, p. 45

<sup>21</sup> Cahill, Adams, Horner, Cahill and Associates, "The Use of Porous Paving for Groundwater Recharge in Stormwater Management Systems", October 1988



Dupont Research Center in Wilmington, DE, SmithKline Beecham Clinical Laboratory in Norristown, PA, and Riverton Country Club in Cinnaminson, NJ -- the oldest being 18 years old, continue to function as designed even during hurricane conditions.<sup>22</sup>

But, as a precaution, system design can include an edge inlet system which allows stormwater to continue to enter the recharge bed should clogging of the pavement occur. In fact, this approach can be used to accommodate a parking design with recharge bed using standard impervious bituminous.

**Appropriate uses for porous paving with recharge bed include:** parking lots, parking bays with impervious roadways, cul-de-sacs, single-home driveways.

Porous paving projects historically have been used on light traffic areas such as parking lots. For high traffic areas a combination of porous paving and standard bituminous have been used to accomplish needed infiltration.

*Cahill Associates, "Stormwater Management Systems, Porous Pavement System with Underground Recharge Beds, Engineering Design Report", Spring, 1993*

✓ "Pavement is structurally unsound or rapidly deteriorates."<sup>23</sup>

While it is true that porous paving has structural limitations, projects which have been properly designed, located and installed have not failed structurally.<sup>24</sup>

✓ "Pavement requires excessive maintenance."<sup>25</sup>

All stormwater structures require maintenance. While vacuuming is recommended, and sands/cinders should not be used for de-icing, to date existing porous paving projects have required little to no maintenance. A number of porous paving project owners have noted that "because the underlying stone bed retains heat, they seldom have to plow or salt the porous parking lots in snow or ice."<sup>26</sup>

✓ "Cost of porous paving is high."<sup>27</sup>

While each project is unique, generally it has been found that porous paving projects cost comparable to or less than construction of conventional stormwater detention basins and associated infrastructure. Further, the acreage needed for a detention basin can be eliminated

<sup>22</sup> Cahill, Adams, Horner, Cahill and Associates, "The Use of Porous Paving for Groundwater Recharge in Stormwater Management Systems", October 1988

<sup>23</sup> Cahill, Adams, Horner, Cahill and Associates, "The Use of Porous Paving for Groundwater Recharge in Stormwater Management Systems", October 1988

<sup>24</sup> Cahill, Adams, Horner, Cahill and Associates, "The Use of Porous Paving for Groundwater Recharge in Stormwater Management Systems", October 1988

<sup>25</sup> Cahill, Adams, Horner, Cahill and Associates, "The Use of Porous Paving for Groundwater Recharge in Stormwater Management Systems", October 1988

<sup>26</sup> Cahill, Adams, Horner, Cahill and Associates, "The Use of Porous Paving for Groundwater Recharge in Stormwater Management Systems", October 1988

<sup>27</sup> Cahill, Adams, Horner, Cahill and Associates, "The Use of Porous Paving for Groundwater Recharge in Stormwater Management Systems", October 1988



when the beds are located under a parking lot -- when land values are considered, this is a hefty savings and can make porous paving projects considerably less expensive.<sup>28</sup>

**Other porous surfaces include:**<sup>29</sup>

- ✓ Porous cement;
- ✓ Open celled pavers which allow cells to be filled with soil sown with grass or filled with a porous aggregate has been used for parking areas, road shoulders, pedestrian ways and other lightly traveled areas like overflow parking areas and emergency access ways;<sup>30</sup>
- ✓ Spacing impervious pavers so as to expose permeable material;
- ✓ Pavement blocks or grids;
- ✓ Compacted gravel is suitable for very light vehicular traffic such as overflow parking areas and service roads. But the effectiveness at infiltrating water is variable and depends on the level of fine particles in the mix;<sup>31</sup>
- ✓ Permeable interlocking concrete paving blocks can accommodate heavy traffic and tire loads. They are long-lived and relatively inexpensive.<sup>32</sup>

Generally these systems are not accompanied by recharge beds and are only appropriate for lightly traveled areas. While these options do allow for more infiltration than a standard pavement, they will still infiltrate much less stormwater than would occur under natural conditions.

**Maintenance**

Properly installed and maintained porous paving can be expected to function effectively for 20 years or more.<sup>33</sup> Maintenance is minimal. There are some tasks that should be performed periodically.

- ✓ Periodic vacuuming is recommended to help maintain pore openings. But, on sites where this protocol has not been followed the porous paving continues to function effectively.<sup>34</sup>

---

<sup>28</sup> Cahill, Adams, Horner, Cahill and Associates, "The Use of Porous Paving for Groundwater Recharge in Stormwater Management Systems", October 1988

<sup>29</sup> Bruce K. Ferguson, Stormwater Infiltration, CRC Press, 1994, p. 50; Pennsylvania Handbook of Best Management Practices for Developing Areas, Prepared by CH2MHILL, Spring 1998

<sup>30</sup> Bruce K. Ferguson, Stormwater Infiltration, CRC Press, 1994, p. 50

<sup>31</sup> Pennsylvania Handbook of Best Management Practices for Developing Areas, Prepared by CH2MHILL, Spring 1998

<sup>32</sup> Pennsylvania Handbook of Best Management Practices for Developing Areas, Prepared by CH2MHILL, Spring 1998

<sup>33</sup> Pennsylvania Handbook of Best Management Practices for Developing Areas, Prepared by CH2MHILL, Spring 1998

<sup>34</sup> Cahill Associates, "Stormwater Management Systems, Porous Pavement System with Underground Recharge Beds, Engineering Design Report", Spring, 1993



✓ Annual inspections during major storm events to ensure continued function is recommended.<sup>35</sup>

✓ No sand, ash or other granular materials should be applied to the porous pavement. "Experience has indicated to date that because of the rapid drainage properties of the porous pavement surface, this type of winter maintenance is not necessary, and that porous pavement tends to melt ice and snow cover much faster than conventional pavement." When necessary only salt or a comparable de-icing product should be used.<sup>36</sup>

✓ Permanent signage of the porous paving area stating any special maintenance needs is highly recommended to help insure that maintenance workers conform to the needs of the pavement, e.g. do not seal, do not apply sand/ash during winter, do not repave with conventional pavement, etc....<sup>37</sup>

---

<sup>35</sup> Cahill Associates, "Stormwater Management Systems, Porous Pavement System with Underground Recharge Beds, Engineering Design Report", Spring, 1993

<sup>36</sup> Cahill Associates, "Stormwater Management Systems, Porous Pavement System with Underground Recharge Beds, Engineering Design Report", Spring, 1993, p. 32.

<sup>37</sup> Cahill Associates, "Stormwater Management Systems, Porous Pavement System with Underground Recharge Beds, Engineering Design Report", Spring, 1993



## Fact Sheet -- Stormwater Runoff, the Lost Resource Constructed Wetlands

Wetlands play an important part in nature's absorption of and distribution of water in the natural ecosystem. Wetlands are part of nature's sponge, holding water, feeding plants, slowly recharging aquifers and acting as a natural pollution filter thereby providing irreplaceable water quality benefits. By learning from nature's employment of wetlands, there are ways in which wetlands and ponds can be used in a man-made stormwater management system. It is important to note however that constructed wetlands cannot be expected to perform as well as natural wetlands, from both a stormwater and ecological perspective. And the jury is still out as to their long-term performance and sustainability. So it is better to preserve and not overwhelm the wetlands that exist on a site.

More than half of the original 215 million acres of wetlands that covered the U.S. before colonial settlement are gone today and many of those remaining are degraded. One half million acres of wetland habitat is destroyed each year.<sup>1</sup> As a result, flooding has increased, habitat for wildlife has been destroyed (in the U.S., more endangered species depend on wetlands than any other habitat type), native plants are being exterminated, and water quality is degraded. The role wetlands play in the natural ecosystem needs to be protected when land is disturbed, and restored when disturbed land is renovated.

In nature, wetlands can help to control stormwater runoff, improve water quality and support a healthy ecosystem of plants, macroinvertebrates, aquatic species and wildlife.

Existing wetlands need to be protected and their function can be built into the stormwater treatment plan for a development site. Disturbance of adjacent lands must be done very carefully, however, because wetlands are easily damaged. Wetlands need an extensive buffer in order to preserve their health. The characteristics of a wetland, the characteristics of the stormwater which will enter the wetland, and the characteristics of the potential BMPs to be used on the site must all be considered. For instance, the hydroperiod (the ratio of flood duration divided by flood frequency over a given period of time -- i.e. the time a wetland is inundated with water) can be changed by adjacent site changes, which will, in turn, impact the water retention and sediment attenuation functions of the wetland. This will effect and can stress indigenous vegetation and the bio-community (microbes, plants, fungi, fishlife, animals) of the wetland and downstream water quality.<sup>2</sup> Ultimately a wetland can be destroyed as a result.

"A well-designed wetlands basin can trap 80 to 100 percent of suspended sediments, remove 60 to 80 percent of total phosphorous and 40 to 60 percent of total nitrogen, and stabilize 60 to 80 percent of trace metals."

Ecological Site Planning Reference File,  
Tourbier & Associates, Inc

<sup>1</sup> "Providing Wetlands for Wildlife While Controlling Stormwater", Penn State College of Agriculture Cooperative Extension, Circular #384.

<sup>2</sup> "Protecting Natural Wetlands; A Guide to Stormwater Best Management Practices", USEPA, October, 1996, p. 2-6





### **Wetlands Improve Water Quality**

Natural wetlands are usually heavily vegetated and serve as a natural filter for runoff.<sup>3</sup> The primary role of constructed wetlands in stormwater management is to provide for a period of detention during which time the quality of the stormwater can be enhanced through physical, chemical, and bio-mechanisms.<sup>4</sup> There are two types: "surface water systems" and "subsurface flow systems".

✓ "Surface water systems" consist of basins or channels that can be made by constructing an impoundment in a low area or in the lower end of a "treatment train" (a series of treatment components). They provide a dense stand of aquatic vegetation that acts as a biological filter that removes pollutants from the stormwater as it passes through the wetland. About 25% of the surface area is open water; the rest is submergent and emergent vegetation.<sup>5</sup>

✓ "Subsurface flow systems" consist of trenches or beds on impermeable soils or a barrier, lined with pea-sized gravel or coarse sand. As stormwater moves through the trenches, set on a slight incline, the roots of the plants remove pollutants.<sup>6</sup> The detention time also slows water flow, settles solids and supplies reduced carbon and attachment area for microbes (bacteria and fungi).<sup>7</sup>

Constructed wetlands can also be a good retrofit for dry stormwater basins as long as there is enough water flow to support the ecosystem.<sup>8</sup> Since conventional stormwater basins are often placed "at the bottom of the hill" in developments and may not offer much infiltration, a wetland retrofit may work where other BMPs may not.

Constructed wetlands can be designed to provide habitat for wildlife and for a wide variety of plants.

### **Wetlands Can Reduce Water Quantity and Peak Flows**

Depending on the soil type, wetlands can contain 1 million to 1.5 million gallons of water per acre, thereby alleviating flooding by holding excess water like a sponge.<sup>9</sup> They also are effective for reducing peak runoff rates (and, therefore, downstream flooding), stabilizing flow to adjacent natural wetlands and streams<sup>10</sup> and providing some (limited) infiltration.

<sup>3</sup> Wetlands Fact Sheets, US EPA, Document Number EPA843-F-95-001, February 1995

<sup>4</sup> Protecting Natural Wetlands: A Guide to Stormwater Best Management Practices, USEPA, October, 1996, p. 4-50

<sup>5</sup> Pennsylvania Handbook of Best Management Practices for Developing Areas, Prepared by CH2MHILL, Spring 1998

<sup>6</sup> New York State Department of Environmental Conservation, Reducing the Impacts of Stormwater Runoff from New Development, April, 1992

<sup>7</sup> Pennsylvania Handbook of Best Management Practices for Developing Areas, Prepared by CH2MHILL, Spring 1998

<sup>8</sup> Protecting Natural Wetlands: A Guide to Stormwater Best Management Practices, USEPA, October, 1996, p. 4-19

<sup>9</sup> Bob Schildgen, "Unnatural Disasters", Sierra, June 1999

<sup>10</sup> Pennsylvania Handbook of Best Management Practices for Developing Areas, Prepared by CH2MHILL, Spring 1998



## Design Considerations

✓ It has been reported that constructed wetlands may not drain as well as natural wetlands.<sup>11</sup>

✓ How well artificial wetlands perform depends on the hydrology of the site, precipitation, infiltration, evapo-transpiration, hydraulic loading rate, water depth, and pH and these factors must be accurately reflected in the design of the system.<sup>12</sup> They also need to be sized according to the pollution load that is anticipated.<sup>13</sup> Specific design criteria which control the amount of shallow and deep surface, the species of plants, the soils and/or liners employed, the elevation and incline, the placement of outlet and inlet structures, are all critical parameters. Some states, such as New York, enforce design criteria strictly in order to have better control of the performance of this BMP.<sup>14</sup>

✓ Mosquitoes and other noxious insects can be effectively controlled through a design which increases the open water area of the wetland to a depth of 7 feet and introduces appropriate fish species.<sup>15</sup> Also, a balanced wetland with the right mix of plants will support the full range of wetland creatures by providing a diverse food chain, keeping mosquitoes in check. For example, the frogs, turtles, and lizards that live in a healthy wetland eat mosquito larvae at a pace that keeps adults under control. In contrast, it has been reported that conventional stormwater basins "are perfect mosquito breeding habitat."<sup>16</sup>

✓ The plants used in a created or restored wetland are critical to its success as a stormwater treatment facility. The low marsh area of a wetland (6 inches to 1 foot) is the primary area where emergent plants are grown. They are often located at the edge of a wetland or on low mounds of earth within a pond.

⊗ The plants used in the low marsh: must be native species; must be able to withstand constant inundation and partial submersion; should enhance pollutant uptake; should provide food and cover for aquatic and non-aquatic life.<sup>17</sup>

⊗ Plants used along the outer edges of a wetland must be able to tolerate inundation but also dry periods when wetness recedes. These plants must be able to withstand wind and provide stabilization from erosion to the edges of the wetland. Many emergent plant species will do well in this transitional zone but may need to be mixed with native grasses and shrubs.<sup>18</sup>

<sup>11</sup> Gary Donato, County Mosquito Inspector, reported by The Hunterdon County Democrat News, May 4, 2000.

<sup>12</sup> New York State Department of Environmental Conservation, Reducing the Impacts of Stormwater Runoff from New Development, April, 1992

<sup>13</sup> Ecological Site Planning Reference File, Tourbier & Associates, Inc.

<sup>14</sup> New York State Department of Environmental Conservation, Reducing the Impacts of Stormwater Runoff from New Development, April, 1992

<sup>15</sup> New York State Department of Environmental Conservation, Reducing the Impacts of Stormwater Runoff from New Development, April, 1992; Ecological Site Planning Reference File, Tourbier & Associates, Inc..

<sup>16</sup> Gary Donato, County Mosquito Inspector, reported by The Hunterdon County Democrat News, May 4, 2000.

<sup>17</sup> 2000 Maryland Stormwater Design Manual, MDE, Volume I, draft, 1999, p.A-7

<sup>18</sup> 2000 Maryland Stormwater Design Manual, MDE, Volume I, draft, 1999, P. A-7



✓ Existing wetlands, restored or newly created wetlands can be used in “treatment trains” (a series of treatment components) to polish runoff so that it can be cleaned, absorbed, and utilized by natural processes, as long as care is given not to allow herbicides and other fatal toxics to be washed into the wetland ecosystem and as long as untreated stormwater is not directly discharged to the wetlands.<sup>19</sup>

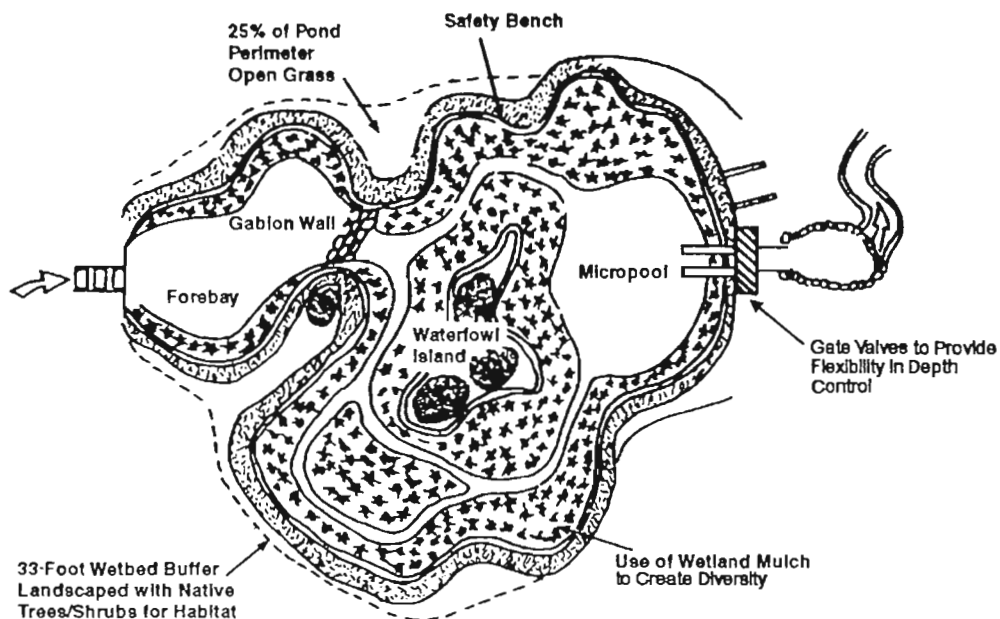

**Constructed wetland for stormwater control with an enhanced shallow marsh system.**

*Reprinted from Protecting Natural Wetlands: A Guide to Stormwater Best Management Practices, USEPA, October, 1996, p. 4-52, adapted from Schueler, 1992.*

<sup>19</sup> New York State Department of Environmental Conservation, Reducing the Impacts of Stormwater Runoff from New Development, April, 1992



## Fact Sheet -- Stormwater Runoff, the Lost Resource Wet Ponds

A wet pond is also known as a retention pond and is usually designed to achieve peak attenuation and pollutant removal. Wet ponds have a permanent pool of water for enhancing water quality as well as additional capacity for capturing and holding stormwater runoff. Collected stormwater runoff is generally released over a period of days until the pond returns to its normal design depth. Water quality improvements are the result of settling of suspended particulate, biological uptake, and the consumption of pollutants by plants, algae and bacteria.<sup>20</sup> There is generally a forebay or smaller settling pond that catches runoff before it enters the pond. A natural vegetated buffer is used to protect the edges of the pond.

A properly sized, well maintained wet pond can achieve a high removal rate of sediment, BOD, nutrients and trace metals. This is primarily attributed to gravity settling of suspended particulates, chemical flocculation, and biological uptake of pollutants by plants, algae and bacteria.<sup>21</sup> A pond can keep 40% to 60% of nutrients and toxic metals in runoff from entering nearby waterways.<sup>22</sup>

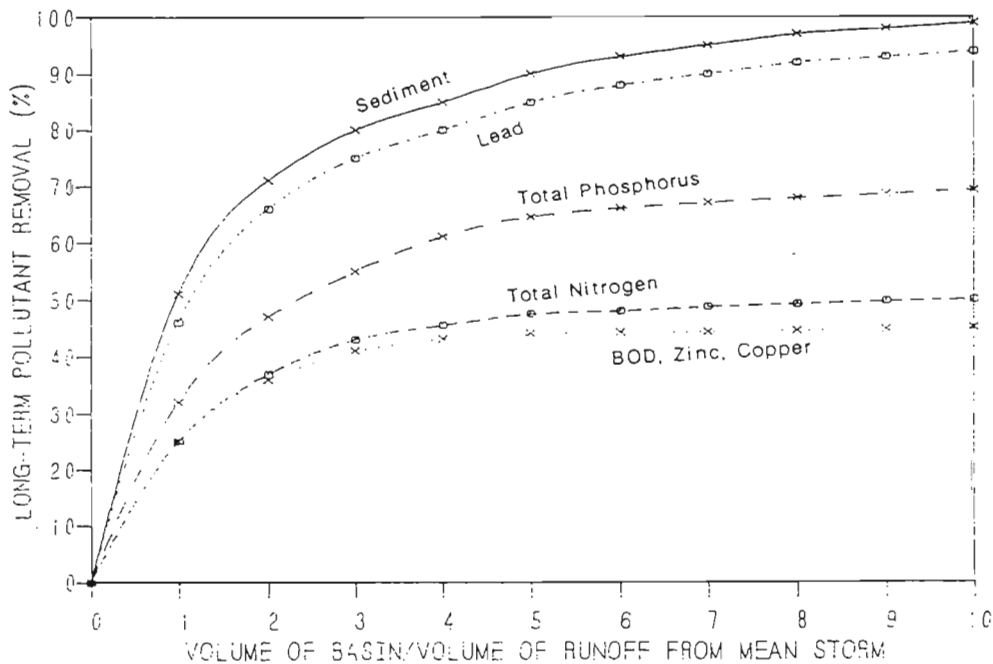

### Wet pond pollution removal rates

Reprinted from *Reducing the Impacts of Stormwater Runoff from New Development*, NYDEC, 1992

<sup>20</sup> Pennsylvania Handbook of Best Management Practices for Developing Areas, Prepared by CH2MHILL, Spring 1998

<sup>21</sup> Pennsylvania Handbook of Best Management Practices for Developing Areas, Prepared by CH2MHILL, Spring 1998; New York State Department of Environmental Conservation, *Reducing the Impacts of Stormwater Runoff from New Development*, April, 1992

<sup>22</sup> "How Much Development is Too Much for Streams, Rivers, Lakes, Tidal waters, and Wetlands?", Community and Environmental Defense Services, Maryland Line, MD



Since the pond stores water rather than recharging it to the ground, it is not effective in controlling post-development increases in total runoff volume from a developed site. The temperature of water and runoff stored in a pond can increase through the heating effects of the sun.<sup>23</sup> Also, groundwater recharge and low flow augmentation from a wet pond are practically non-existent since the pond is not constructed to infiltrate and is usually built at a low spot that has non-permeable soils.

The wet pond is best suited for low-density residential or commercial developments since they require a larger land area.<sup>24</sup> Additionally, it is important to have a reliable source of clean water to maintain the permanent pool.

Wet ponds are often used in "treatment trains" (a series of treatment components) with other BMPs to accomplish multiple objectives. This has more benefit and spreads out the cost, making wet ponds more cost-efficient.

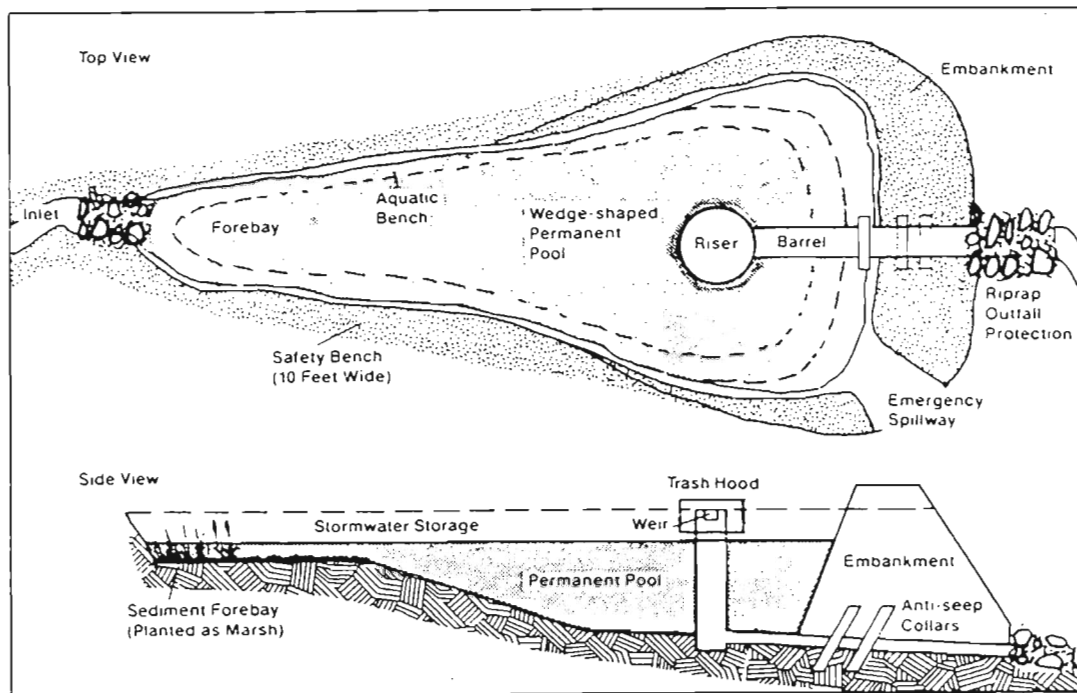

### Wet Pond

*Reprinted from Stormwater Management in the New Jersey Coastal Zone, Prepared by Cahill Associates for NJ DEP, April 1989.*

<sup>23</sup> "How Much Development is Too Much for Streams, Rivers, Lakes, Tidal waters, and Wetlands?", Community and Environmental Defense Services, Maryland Line, MD

<sup>24</sup> Pennsylvania Handbook of Best Management Practices for Developing Areas, Prepared by CH2MHILL, Spring 1998; New York State Department of Environmental Conservation, Reducing the Impacts of Stormwater Runoff from New Development, April, 1992



Wildlife can also benefit from a wet pond at the same time stormwater is being controlled. For instance, by constructing a pond so that the shoreline is maximized and irregular, nesting pairs of waterfowl can be visually isolated from one another, enhancing their habitat.<sup>25</sup> Building in mud flats and vegetated islands provide places for birds and reptiles/herptiles to feed and nest. Shrubs and trees along the shoreline cool the water, provide nest and perch sites and cover.<sup>26</sup> Wide, vegetated, riparian buffers prevent some birds from becoming pests (geese won't take advantage of a pond that is protected by shrubbery and doesn't allow for easy landing). Using these methods to enhance a pond or wetland as part of a stormwater system allows it to function as a whole ecosystem, ensuring more success as a control for stormwater, lowering costs because of multiple benefits, and building in low maintenance. These all make the stormwater control system more economical and more effective.

### **Maintenance**

Maintenance of wet ponds is modest but inspections must be done regularly to guard against the buildup of sediments. The forebay should be kept clear of debris, natural buffers need to be healthy and functioning, the banks stable. Rodent holes and tree roots in the embankments can cause bank failure. All piping and the spillway need to be kept clear. The stream above and below the pond needs to be checked to make sure protection measures are in place. Fish and a balanced ecosystem of fauna can control insects. If sediments do build up in a pond, they need to be removed if the storage capacity is significantly reduced.<sup>27</sup>

---

<sup>25</sup> "Providing Wetlands for Wildlife While Controlling Stormwater", Penn State College of Agriculture Cooperative Extension, Circular #384. P. 5

<sup>26</sup> "Providing Wetlands for Wildlife While Controlling Stormwater", Penn State College of Agriculture Cooperative Extension, Circular #384. P. 5

<sup>27</sup> Protecting Natural Wetlands: A Guide to Stormwater Best Management Practices, USEPA, October, 1996, p. 4-49





## Fact Sheet -- Stormwater Runoff, the Lost Resource Infiltration Basins

An infiltration basin is a basin that captures stormwater from adjacent areas and allows it to gradually infiltrate through the soil of the bed and sides of the basin. Basins can be adapted to relatively large drainage areas and can provide full control of the peak flow rate for large storms.<sup>1</sup> Conventional basins can, with careful design, be retrofitted as infiltration basins, depending on site specific conditions.

Infiltration basins simultaneously serve multiple purposes: they capture stormwater that would otherwise be lost, recharging it to the groundwater, preserving the water balance of a site; they treat the first flush of stormwater, removing both soluble and fine particulate pollutants; they provide peak rate reduction of the two year storm event; they avoid the increase of volume of runoff to the stream; they can maintain base flow in the receiving stream in critical dry weather periods by recharging the aquifer; they allow water to naturally cool before being discharged as base flow; they avoid the low dissolved oxygen impacts to the receiving stream that ponds cause; they allow for localized stream bank stabilization; they can be designed to function for wildlife habitat, providing water, vegetation and other habitat needs;<sup>2</sup> they can be designed to provide complete control of large storms; and they can be adapted to relatively large drainage areas (ie. 50 acres).<sup>3</sup>

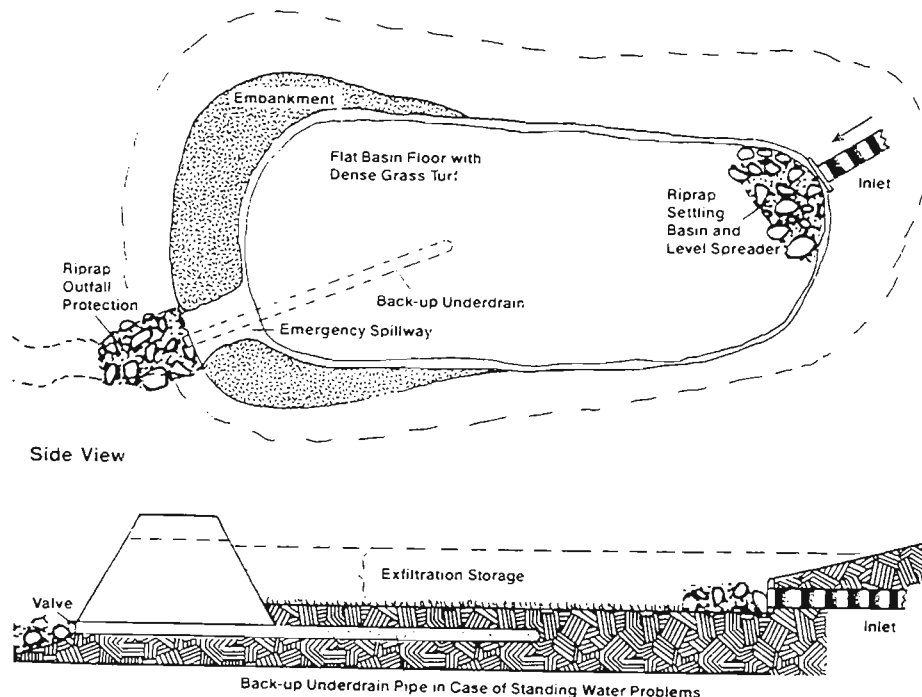

### Infiltration Basin

*Reprinted from Stormwater Management in the New Jersey Coastal Zone,  
Prepared by Cahill Associates for NJ DEP, April 1989.*

<sup>1</sup> Protecting Natural Wetlands: A Guide to Stormwater Best Management Practices, USEPA, October, 1996

<sup>2</sup> Bruce K. Ferguson, Stormwater Infiltration, CRC Press, 1994, p. 64

<sup>3</sup> Protecting Natural Wetlands: A Guide to Stormwater Best Management Practices, USEPA, October, 1996, p. 4-35



Basins can be used to accomplish a number of objectives:<sup>4</sup>

- ✓ Infiltrating the increase in volume that results from development;
- ✓ Infiltrating a fixed volume of runoff;
- ✓ Reducing overflow to a given rate;
- ✓ Filtering out nonpoint source pollution;
- ✓ Recharging aquifers and maintaining stream baseflow;
- ✓ Providing wildlife habitat.

The first flush of a storm carries with it most of the pollutants washed from the land including solids, microorganisms, metals, nutrients and organic compounds. As a result, significant pollutant removal can be accommodated with infiltration designed for a small quantity of runoff, such as all storms up to the 2-year storm. Both soluble and fine particulates are effectively removed.

One approach to stormwater management relies on using several small basins to accomplish the same job as one big basin. For example, smaller basins that catch water and provide an infiltration opportunity can be used in interchange areas, under decks, along highway shoulders and in parking lot islands.<sup>5</sup>

Because infiltration basins are designed to capture and infiltrate water they don't require an outlet to drain the water and so you avoid "the most dangerous feature of stormwater basins, a vortex at the submerged mouth of a culvert operating under inlet control."<sup>6</sup>

### **Design Considerations**

✓ In addition to above ground basins, there are submerged basins made of stone, pipe or chambers underground.

✓ Vegetating basins can help improve infiltration and battle loss of porosity by maintaining and building macropores, dispersing rainfall energy, and maintaining microtopography and stimulate differential accumulation of sediments.<sup>7</sup>

✓ It is critical that developers be vigilant during construction of infiltration basins, preventing entry of sediments and solids that may clog the basin. Post construction inspection is also recommended.<sup>8</sup> And it is recommended that the basin be mulched after construction until plants take hold to prevent erosion and sedimentation.<sup>9</sup>

<sup>4</sup> Bruce K. Ferguson, *Stormwater Infiltration*, CRC Press, 1994, p. 133

<sup>5</sup> Bruce K. Ferguson, *Stormwater Infiltration*, CRC Press, 1994, p. 57

<sup>6</sup> Bruce K. Ferguson, *Stormwater Infiltration*, CRC Press, 1994, p. 64

<sup>7</sup> Bruce K. Ferguson, *Stormwater Infiltration*, CRC Press, 1994, p. 198 & 199

<sup>8</sup> Bruce K. Ferguson, *Stormwater Infiltration*, CRC Press, 1994, p. 81

<sup>9</sup> Bruce K. Ferguson, *Stormwater Infiltration*, CRC Press, 1994, p. 199



✓ It is important to size an infiltration basin so it can accommodate anticipated stormwater flows.<sup>10</sup> Correct sizing involves a number of considerations including site specific soils and watershed characteristics.<sup>11</sup>

✓ Broad, gently sloping, vegetated slopes and swales that guide stormwater into the basin at a low velocity can help prevent erosion.<sup>12</sup>

✓ It is good to size a basin so it can drain between storms to stimulate soil aggregation and aerobic humus-building, and to help inhibit clogging by microbial growth.<sup>13</sup>

✓ It is recommended that infiltration basins maintain a 3-meter vadose zone above the water table. In this distance chemicals and pathogenic bacteria can be filtered out by vertical percolation.<sup>14</sup>

**Definition: Vadose Zone** -- the vadose zone lies above the water table and, although not saturated with water, it can hold considerable amounts by capillary action. Measurement of water in this zone is usually expressed as 'soil moisture.'

✓ Soil permeability should be .5 inches per hour so that the basin can empty enough in 72 hours to provide storage for larger storms.<sup>15</sup> Vegetation can improve permeability. However, the soil shouldn't percolate too quickly in order to achieve water quality benefits. To ensure that soil permeability is effective for pollutant removal purposes, some States (such as Washington) have required that the soil in the first 45 centimeters under a basin has hydraulic conductivity not exceeding 6 cm/h and a cation exchange capacity of at least 5 miliequivalents per 100 grams of dry soil. Where soils do not meet this requirement a fine textured soil can be added as a liner to the basin floor. Pre-treatment in a settling basin could be used or flows could be limited to relatively clean runoff such as rooftop runoff.<sup>16</sup>

✓ During construction, care must be taken to avoid compaction with heavy equipment. This can be done by building the basin from the outside in -- reaching into the basin center and scooping outwards.

✓ Mosquitoes can be avoided by sizing basins for either dry or wet regimes. Dry basin design allows all water to infiltrate quickly so that the mosquito larvae do not live through their cycle. Wet basin depth can be designed to avoid mosquitoes (over seven feet deep). Creating a wet basin designed to accommodate fish that eat mosquito larvae and making sure that the wet basin habitat is designed to support a balance of living creatures can keep mosquitoes in check.<sup>17</sup>

<sup>10</sup> Bruce K. Ferguson, Stormwater Infiltration, CRC Press, 1994, p. 125

<sup>11</sup> Bruce K. Ferguson, Stormwater Infiltration, CRC Press, 1994, p. 125

<sup>12</sup> Bruce K. Ferguson, Stormwater Infiltration, CRC Press, 1994, p. 198

<sup>13</sup> Bruce K. Ferguson, Stormwater Infiltration, CRC Press, 1994, p. 198

<sup>14</sup> Bruce K. Ferguson, Stormwater Infiltration, CRC Press, 1994, p. 156

<sup>15</sup> Protecting Natural Wetlands: A Guide to Stormwater Best Management Practices, USEPA, October, 1996, p. 4-21

<sup>16</sup> Bruce K. Ferguson, Stormwater Infiltration, CRC Press, 1994, p. 157

<sup>17</sup> Bruce K. Ferguson, Stormwater Infiltration, CRC Press, 1994, p. 66



## Maintenance

As with all stormwater management systems, maintenance is important. Basins should be constructed to provide for monitoring and maintenance access at the ultimate place where sediment would accumulate and water would stand.<sup>18</sup> There should be a well or inlet into which hoses, pumps and/or other equipment can be lowered.<sup>19</sup> Many local regulations require minimum diameters for drainage culverts so they are accessible and maintainable. This same minimum size could be applied to wells or inlets for subsurface basins.<sup>20</sup>

Using a conventional looking drainage inlet makes it likely that even crews unfamiliar with infiltration basins would check there first for problems. If accumulated sediment or mud was found, the first instinct of the crewmen -- to pump it out -- would be the correct action to take.<sup>21</sup>

Infiltration surfaces and basins should be monitored on the same schedule as other drainage structures in the community. Relatively frequent inspection (about twice per year) and maintenance is the minimum recommended.<sup>22</sup> It is best to monitor during low flows when the basin is expected to be dry.<sup>23</sup> "The most obvious signal that an infiltration basin is not working properly is the same as for any other drainage structure: prolonged ponding over the surface of the adjoining ground."<sup>24</sup> Basins that are not working can be rehabilitated.

Sediment removal, tilling, erosion control, and debris removal is routine. Sediment removal needs will vary based on whether there is vegetation, how much storage is in the basin, how quickly it recharges, volume of inflow and sediment load. The basin needs annual inspection for erosion of side slopes, cracking, leakage, and differential settlement or tree root invasion on the embankments. Maintaining dense vegetation on side slopes and along the edges of the basin helps to prevent erosion and weed growth, provides stabilization of the bed, pre-treatment of coarse sediments that are filtered out, and promotes infiltration of water through the basin's sides.<sup>25</sup>

---

<sup>18</sup> Bruce K. Ferguson, *Stormwater Infiltration*, CRC Press, 1994, p. 201

<sup>19</sup> Bruce K. Ferguson, *Stormwater Infiltration*, CRC Press, 1994, p. 201

<sup>20</sup> Bruce K. Ferguson, *Stormwater Infiltration*, CRC Press, 1994, p. 201

<sup>21</sup> Bruce K. Ferguson, *Stormwater Infiltration*, CRC Press, 1994, p. 201

<sup>22</sup> *Protecting Natural Wetlands: A Guide to Stormwater Best Management Practices*, USEPA, October, 1996, p. 4-24

<sup>23</sup> Bruce K. Ferguson, *Stormwater Infiltration*, CRC Press, 1994, p. 202

<sup>24</sup> Bruce K. Ferguson, *Stormwater Infiltration*, CRC Press, 1994, p. 202

<sup>25</sup> *Protecting Natural Wetlands: A Guide to Stormwater Best Management Practices*, USEPA, October, 1996, p. 4-24

## Fact Sheet -- Stormwater Runoff, the Lost Resource Vegetated Rooftops and Roof Ponding Areas

A vegetated roof cover is a "veneer of living vegetation that is installed on top of a conventional roof".<sup>1</sup> In urban areas where there may be limited opportunity to channel rooftop runoff to vegetated areas for infiltration, vegetated rooftops are a viable alternative particularly since urban land is so valuable and these systems don't use any.<sup>2</sup> The rooftop becomes an absorbent medium that captures rainfall and prevents and/or reduces rooftop-induced runoff.

Rooftop runoff management is basically designed to delay peak runoff and to lower runoff discharge rates. Rooftop runoff measures are suitable for flat or gently sloping roofs and they can be retrofitted to most conventionally constructed buildings.<sup>3</sup> Vegetated roofs can generally be constructed on existing flat roofs without any additional structural support. "Frequently, the total load of a fully vegetated and saturated roof cover system actually will be less than the design load computed for the gravel ballast on conventional tar roofs."<sup>4</sup>

Vegetated roof covers are comprised of:

- ✓ an impermeable lining,
- ✓ a drainage net or sheet drain,
- ✓ lightweight growth media, and
- ✓ plants and grasses.

The drainage layer between the growth media, the plants and the roof surface conveys water off of the roof surface.

While most effective during the growing season, these systems are also effective in winter if the vegetative matter (dead and dormant) is left in place and intact. Because these systems filter out leaves and other debris this is the recommended approach if rooftop runoff is to be directed to infiltration devices.<sup>5</sup>

An added benefit of vegetated roof top systems is that vegetated roof covers protect roof materials and can prolong their life. They also add insulation to a building benefiting both heating in the winter and cooling in the summer. The ecological and aesthetic value of the vegetated open space is another big plus.<sup>6</sup>

<sup>1</sup> Charlie Miller, P.E., "Vegetated Roof Covers, A New Method for Controlling Runoff in Urbanized Areas", 1998 *Pennsylvania Stormwater Management Symposium*, October, 1998

<sup>2</sup> Charlie Miller, P.E., "Vegetated Roof Covers, A New Method for Controlling Runoff in Urbanized Areas", 1998 *Pennsylvania Stormwater Management Symposium*, October, 1998

<sup>3</sup> Pennsylvania Handbook of Best Management Practices for Developing Areas, Prepared by CH2MHILL, Spring 1998

<sup>4</sup> Pennsylvania Handbook of Best Management Practices for Developing Areas, Prepared by CH2MHILL, Spring 1998

<sup>5</sup> Pennsylvania Handbook of Best Management Practices for Developing Areas, Prepared by CH2MHILL, Spring 1998

<sup>6</sup> Charlie Miller, P.E., "Vegetated Roof Covers, A New Method for Controlling Runoff in Urbanized Areas", 1998 *Pennsylvania Stormwater Management Symposium*, October, 1998



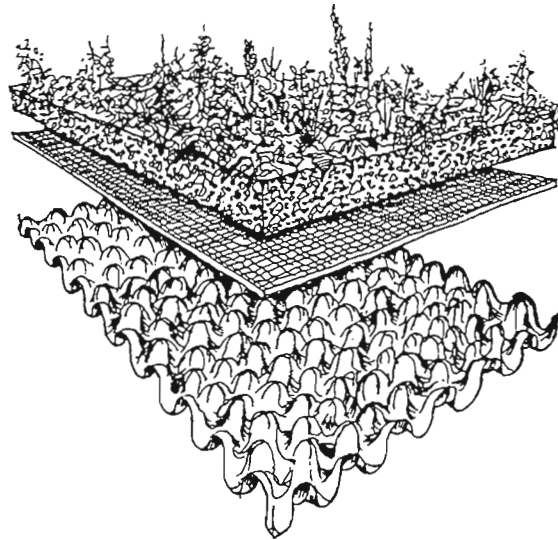

Vegetative Layer

Media

Geotextile

Synthetic Drain Layer

### Structure of the Philadelphia Roof Cover

*Charlie Miller, P.E., "Vegetated Roof Covers, a New Method for Controlling Runoff in Urbanized Areas", 1998 Pennsylvania Stormwater Management Symposium, October 1998*

#### Variations on the vegetated rooftop theme include:

✓ Roof gardens: Landscaped environments that may include planters, potted shrubs and trees. "Because of the special requirements for access, structural support, and drainage, roof gardens are found most frequently in new construction."<sup>7</sup>

✓ Vegetated building facades: A vertical façade that can be covered with foliage of self-climbing plants that are rooted to the ground. These will also intercept precipitation and retard runoff. But they are only effective in small rain events.<sup>8</sup>

✓ Roof ponding areas: Small ponds on roof areas. "Even small ponding depths of 1 or 2 inches can attenuate stormwater runoff peaks effectively for most storms." Flat roofs can be turned into ponding areas simply by restricting the flow to downspouts.<sup>9</sup>

A lightweight vegetated roof cover has been retrofitted on a rooftop in Philadelphia by Roofscapes, Inc. and is designed to control the 2-year storm volume. Since 90% of all rainfall in Philadelphia is from storms that produce 2 inches or less of rain and these occur 3 to 4 times annually, the reduction in runoff from the roof cover is significant. These are the storms that produce chronic urban problems such as overflows of combined sewer systems, stream bank erosion, and nuisance flooding of roads and walkways<sup>10</sup> -- so the effects of reducing or eliminating this runoff goes a long way for the urban community.

<sup>7</sup> Pennsylvania Handbook of Best Management Practices for Developing Areas, Prepared by CH2MHILL, Spring 1998

<sup>8</sup> Pennsylvania Handbook of Best Management Practices for Developing Areas, Prepared by CH2MHILL, Spring 1998

<sup>9</sup> Pennsylvania Handbook of Best Management Practices for Developing Areas, Prepared by CH2MHILL, Spring 1998

<sup>10</sup> Charlie Miller, P.E., "Vegetated Roof Covers, A New Method for Controlling Runoff in Urbanized Areas", 1998 Pennsylvania Stormwater Management Symposium, October, 1998



## Fact Sheet -- Stormwater Runoff, the Lost Resource Rain Barrels and Rain Gutter Retrofits

Rooftops contribute a significant volume of runoff from residential sites. Some low tech solutions for reducing this volume of runoff and maximizing infiltration include:

### **Rain Barrels:**

While any barrel can be used (with a thin film of cooking oil on top of the water to retard insect growth), manufactured rain barrels with lids and spigots are becoming more commonly available through catalogs and hardware stores. Rooftop runoff is directed to the barrel where the water collects and can later be used to water lawns and gardens.

### **Rain Gutter Retrofits:**

Flexaspouts attached to the end of the rain spout from your gutter can easily be used to redirect runoff from driveways or roadways. Stormwater discharged to driveways and roadways is conveyed directly to the storm sewer and then the local stream. With a flexaspout, the water can instead be redirected into gardens and lawns where it is given the opportunity for infiltration. Flexaspouts are readily available at low cost (under \$10 in the year 2000) at local hardware stores.

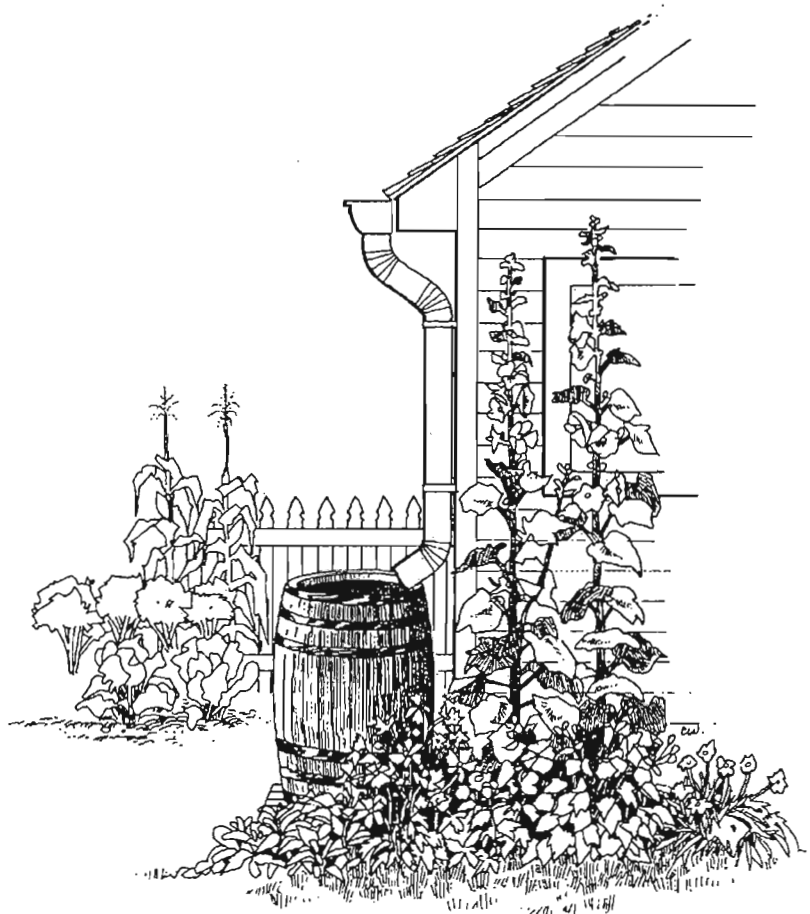

Rain handlers can be used to replace gutters. They intercept and disperse runoff uniformly from the roof rather than capturing and channeling rain fall through a gutter system. If placed adjacent to a vegetated area, infiltration can be maximized.



## Fact Sheet -- Stormwater Runoff, the Lost Resource Additional Ideas for Site Specific Solutions

### Dry Wells:

Dry wells are subsurface basins that, in proportion to their horizontal dimensions, are very deep. They can be used to capture and infiltrate rooftop runoff. In addition, these infiltration pits or perforated gravel-filled tanks<sup>1</sup> can be used to get rid of standing water at the bottom of a basin, and to help improve the holding capacity and infiltration of slowly infiltrating soils. It is a good idea to place a filter aggregate over the top of the well that can be easily replaced if it becomes clogged.<sup>2</sup>

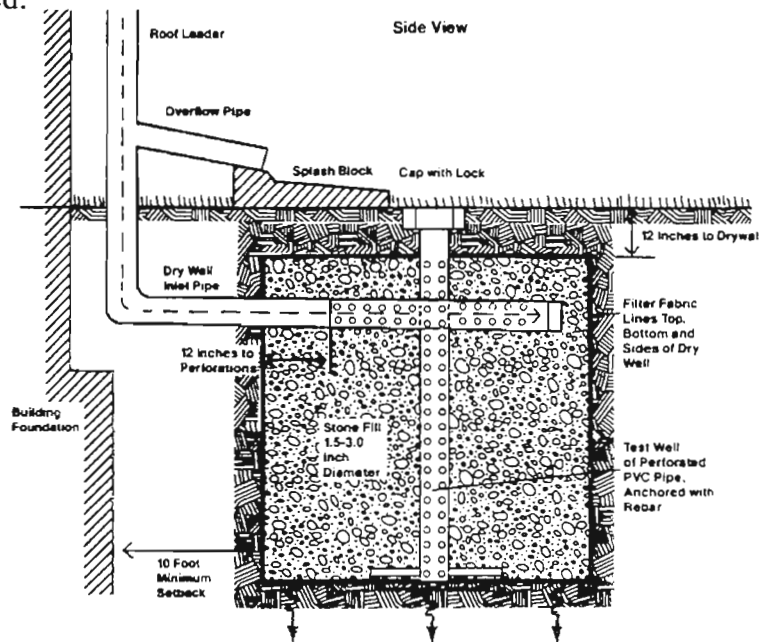

### Dry Well/Infiltration Pit

Reprinted from "Protecting Natural Wetlands; A Guide to Stormwater Best Management Practices", USEPA, October, 1996, adapted from Milone & MacBroom, Inc., 1991.

### Water Quality Inlet:

The water quality inlet consists of an underground chamber or series of chambers that separate out pollutants—also known as an oil/grit separator. It catches sediment and hydrocarbons as they come off an impervious surface, such as a parking lot, before they reach a BMP, such as an infiltration basin, thereby protecting them from clogging. Because the inlet is so small, it plays no part in peak attenuation and it only catches heavier sediment because there is limited time for fine silt to settle out. Soluble pollutants are not removed. Design criteria require a trash rack, sediment chamber, outlet chamber, and access manhole for clean-out. Water quality inlets are used for small (usually less than one acre) impervious areas such as a parking lot.<sup>3</sup>

<sup>1</sup> Protecting Natural Wetlands: A Guide to Stormwater Best Management Practices, USEPA, October, 1996

<sup>2</sup> Bruce K. Ferguson, *Stormwater Infiltration*, CRC Press, 1994, p. 78

<sup>3</sup> New York State Department of Environmental Conservation, *Reducing the Impacts of Stormwater Runoff from New Development*, April, 1992





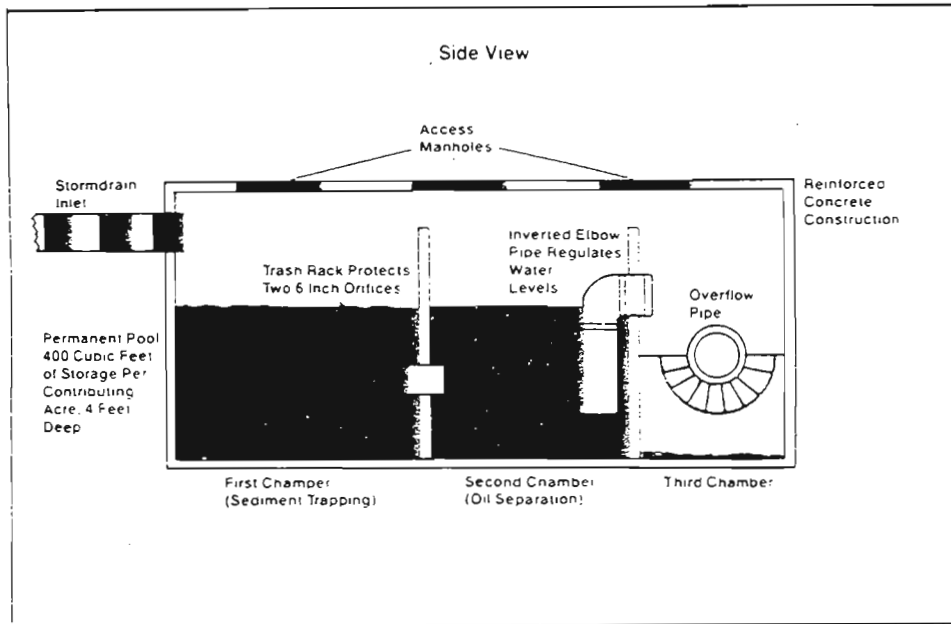

### Water Quality Inlet

*Reducing the Impacts of Stormwater Runoff from New Development, NYDEC, 1992*

### Exfiltration Trenches

Also known as "leaky pipes", exfiltration trenches employ underground slotted pipe sections. The pipes store water temporarily and discharge it to the groundwater over time. Often used in tandem with other BMPs, since they require pre-treatment to remove large particles of sediment and debris that can clog the pipes. The end of the pipe is restricted with a plate or high-level overflow device.

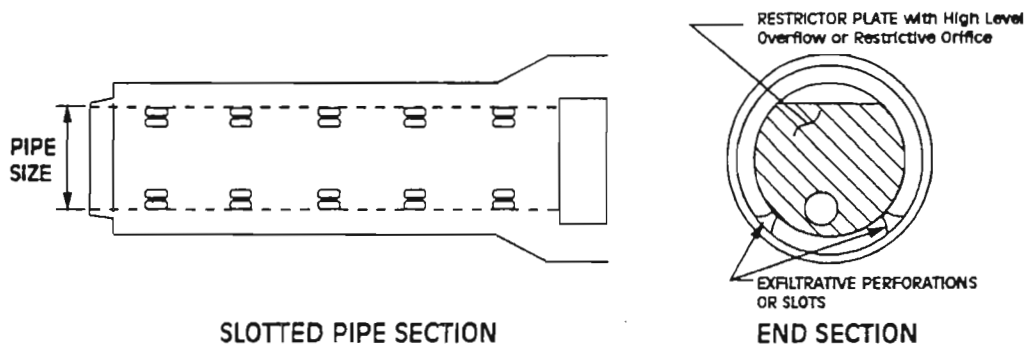

### Exfiltration Trench

*Reprinted from "Protecting Natural Wetlands; A Guide to Stormwater Best Management Practices", USEPA, October, 1996, adapted from Milone & MacBroom, Inc., 1991.*



## **Sand Filters**

This structural BMP consists of a series of underground pipes beneath a bed of sand and is used to treat runoff from an impervious surface such as a parking lot. The runoff infiltrates through the sand, is collected in the pipes, and can then be routed to an infiltration system. Peat, limestone, gravel, or topsoil layers can be added to improve efficiency.

Sand filters provide significant pollution removal of sediments, metals, nutrients, BOD, and fecal coliform.<sup>4</sup> Average removal rates of 85% for sediment, 35% for nitrogen, 40% for fecal coliform, and 50 to 70% for trace metals have been reported.<sup>5</sup> They are good retrofits for urban areas.<sup>6</sup>

---

<sup>4</sup> *Protecting Natural Wetlands: A Guide to Stormwater Best Management Practices*, USEPA, October, 1996, p. 4-29

<sup>5</sup> *Protecting Natural Wetlands: A Guide to Stormwater Best Management Practices*, USEPA, October, 1996, p. 4-29

<sup>6</sup> *Protecting Natural Wetlands: A Guide to Stormwater Best Management Practices*, USEPA, October, 1996, p. 4-29





## C. Infiltration and Best Management Practices are also a Solution for Existing Development

### 1. Changing the Way Things Are

In the urban setting, a typical city block generates nine times more runoff than woodland of the same size.<sup>157</sup> Storm sewer systems typically catch runoff and direct it straight into the closest surface body of water. But even built-out urban settings can be retrofitted to better absorb rainfall and avoid direct discharge of high volume, high velocity, and polluted runoff. BMPs can be retrofitted into existing developments using the same design concepts as for new developments.<sup>158</sup>

There are many BMPs which work well for areas already developed. Nonstructural and structural BMPs can be applied to existing urban and suburban development in order to attenuate the peak rate of runoff, reduce the volume of stormwater to the stream and improve the water quality of the discharged runoff.

#### ***a. Identifying Opportunities for Reducing Runoff and Increasing Infiltration***

Roofs, lawns and parking lots are major sources of stormwater runoff in the developed landscape. At the same time, they offer tremendous opportunity for improvement, especially in the urban setting.

#### Roofs

Roofs are one of the largest sources of concentrated runoff from developed sites. If runoff is retarded at the source, pressure can be taken off of existing stormwater systems. Therefore, rooftop runoff management should be considered as part of any effort to retrofit runoff peak detention in highly urbanized areas. For example, vegetated rooftops are a proven technology in central Europe and can be effectively used to reduce rooftop runoff.<sup>159</sup>

#### Lawns

One often overlooked source of stormwater runoff is the turf grass that makes up residential and commercial lawns. The absence of trees, shrubs and natural vegetation compromises the ability of the soil to percolate rainfall. The soils are also compacted by heavy equipment used for construction. Turf grasses neither rehabilitate the soil nor are they an effective means of capturing and infiltrating rainwater. Open lawns become just another source of stormwater runoff like other impervious surfaces. An effective urban/suburban retrofit is to remove sod and plant with deep-rooted native grasses, shrubs and trees which restore the soils' ability to capture and infiltrate rainfall. As the vegetated area matures, its stormwater capabilities improve.

Americans spend over \$7.5 billion each year in lawn care products to maintain turf lawns. This includes the purchase of over 67 million pounds of pesticides which often end up in stormwater runoff."

*"Better Site Design: A Handbook for Changing Development Rules in Your Community", Center for Watershed Protection, August, 1998, p. 156*



## Parking Lots

Parking lots cover much of the urban and suburban landscape. They provide zero infiltration and are a significant source of point and nonpoint source pollution to our waterways. Redevelopment of existing parking areas offer an excellent opportunity for replacing this impervious surface. Porous paving with recharge technology reduces runoff volume, improves water quality and recharges our aquifers.<sup>160</sup> Improvement can also be provided by smaller efforts such as infiltration trenches and by re-designing vegetated islands or strips that are typically on raised beds in parking lots in a way that encourages rainfall capture and recharge. This is done by replacing existing raised islands with appropriately vegetated, sunken beds (sunken to just below the surface level of the parking lot), allowing rain to flow into the beds and infiltrate rather than run off.<sup>161</sup>

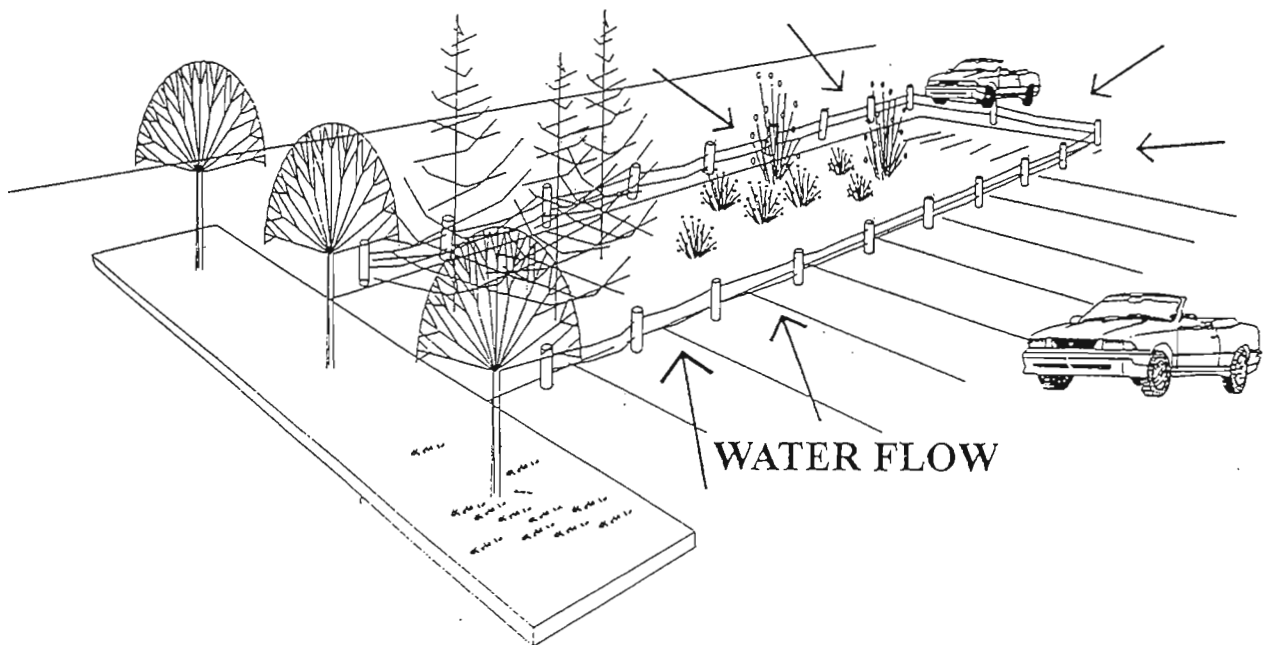

### **Retrofitting parking lot islands for stormwater management**

*"Impervious Surface Coverage, the Emergence of a Key Environmental Indicator", by Chester L. Arnold Jr., and C. James Gibbons, APA Journal, Spring 1996*

While developed areas seem a greater challenge for the reduction of stormwater impacts, they can greatly benefit from the application of a wide array of BMPs.

In addition to other living BMPs explored in this handbook, other nonstructural BMPs for existing development and urban areas include: anti-litter ordinances and educational programs; erosion controls and re-vegetation of existing development commons, parks, and open space; replacement of existing paving with "vest pocket parks", vegetative infiltration strips, and other ecological restoration and retrofit measures; stream bank restoration and riparian

vegetative buffer installation; frequent trash removal and street cleaning; cleaning of catch basins and sewer pipes; improved de-icing methods; regulations controlling herbicide and pesticide usage; spill containment systems for facilities that use and store chemicals; stringent construction regulations and effective stormwater and development regulations for areas being redeveloped; diligent enforcement of regulations through regular inspection; and air pollution abatement.

Stormwater infiltration systems and structural BMPs can be effectively applied to existing development and urban areas. Some BMPs will provide only peak flow attenuation (and little or no volume reduction) but do provide water quality enhancement of runoff, which has great value. Retrofitting urban areas can also involve the modification of existing structural systems.<sup>162</sup> Structural BMPs for urban areas can be relatively more expensive but can provide tremendous benefit in terms of reduced flood flows, increased aquifer recharge, decreased sedimentation to streams, and improved water quality.

Often combining BMPs will be more effective than using one BMP for an existing development site. Site specific needs will define which BMPs are best employed.

There are many retrofit BMPs that are inexpensive and easily implemented. Some of the most effective are:

- ✓ Replacing macadam paths with granular paths;
- ✓ Loosening soils beneath vacant lots that are compacted and opening them up as community gardens;
- ✓ Replacing turf with mixed native vegetation in traffic circles and other open green spaces;
- ✓ Use of public rights of way (land under bridges and overpasses, median strips, exit ramp rights-of-way off highways, etc.) for vegetated swales or meandering vegetated channels;<sup>163</sup>
- ✓ Incorporate filter strips to receive runoff from paved areas. Sometimes this re-routing merely requires removing or slotting curbs along roadways or parking lots;<sup>164</sup>
- ✓ Bioretention facilities can be built to include existing natural depressions and existing or installed roadside swales;<sup>165</sup>
- ✓ Replacing drain pipes with infiltration trenches<sup>166</sup>;
- ✓ Replacing paved low-flow channels in detention basins with meandering vegetated swales;<sup>167</sup>
- ✓ Eliminating low flow bypass in existing detention basins;<sup>168</sup>
- ✓ Regrading basin bottoms to create a wetland area near the outfall or throughout the basin to enhance pollutant removal;<sup>169</sup>

### **Urban Retrofits Pay Off by Reducing Pollutants**

In Alexandria, Virginia, nearly 1000 acres of urban BMP retrofits have been implemented by developers when a property was being redeveloped downgraded of a site identified as a retrofit opportunity. Another 1000 acres are being treated by privately installed BMPs required under the city's new development code. As a result of these retrofits, 20% of the city's total land area received stormwater BMP treatment. Total annual pollutant removal for these projects is estimated at 2,545 pounds of phosphorous per year and 10,193 pounds of nitrogen per year to the Potomac River watershed. This is a good example of the benefits of urban retrofitting for stormwater and it is a good model of how these retrofits can be accomplished.

*"Stormwater Strategies, Community Responses to Runoff Pollution", Natural Resources Defense Council, 1999*



✓ Poking holes in plastic or clay liners of existing detention basins or remove existing liners.

It is important to consider that when placing retrofits on public lands, offering community value such as park settings, fishing and/or tree shading, there is added incentive for employing the retrofit.<sup>170</sup>

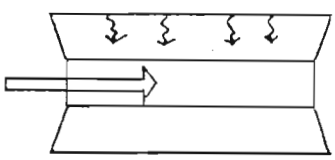
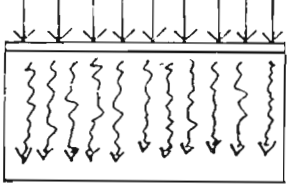
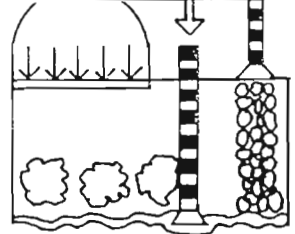
F I L T E R	Open Channel Systems	Filter Strip Systems	Buffer Systems
			
F L O W	shallow flow occurs through a designed open channel, concentrated outflow	grass filter that accepts sheetflow from adjacent areas, no concentrated outflow	primarily used to protect stream, but can act as a filter under restricted conditions
T E R M S	swale (wet or dry) grass channel grass swale bioswale biofilter bioretention swale	filter strip vegetated filter strip grass filter strip grass buffer bioretention area	forest buffer stream buffer riparian filter buffer strip urban buffer treatment

### Some urban vegetative filtering systems

*Reprinted from Site Planning for Urban Stream Protection, by the Center for Watershed Protection, co-published by the Metropolitan Washington Council of Governments, December 1995*

#### **b. The "Ultra-Urban" Option: The Last Choice**

Some built-out areas and urban settings have very little space for stormwater systems. In these cases, "ultra-urban" BMPs may be required. Ultra-urban BMPs include: vegetated rooftop retrofits, the sand filter<sup>171</sup> (although under certain conditions sand filters can become net exporters of nutrients); water quality inlet/oil-grit separator; dry wells; exfiltration trenches. (See Fact Sheets) These are used primarily for water quality improvement and do not infiltrate storm flows, although they do attenuate peak flows.<sup>172</sup>



### c. Funding Options

Implementation of urban runoff control programs often need funding at the local level. Sources for funding need to be developed as part of the nationwide effort to gain control of stormwater runoff. In an effort to create sustainable funding sources there are a number of ideas that are being developed, proposed and/or implemented across the nation including: stormwater utilities; State revolving loan funds; special fees and taxes such as user fees on existing municipal stormwater systems, pesticides and fertilizers, waste disposal, and underground storage tanks; special tax districts, such as watershed protection districts formed to protect high or exceptional quality waters; check-offs on tax payment forms; revenue bonds; pro-rata share fees for developers of re-development projects; and special license plates (used in Maryland and Virginia, substantial monies have been raised to restore the Chesapeake Bay).<sup>173</sup>

In the short term, state and federal grant programs are providing funding to design, implement and study stormwater BMPs. A phone call to the local environmental protection agency, either state or federal, will help identify the most recent and up-to-date funding programs, their requirements and deadlines.

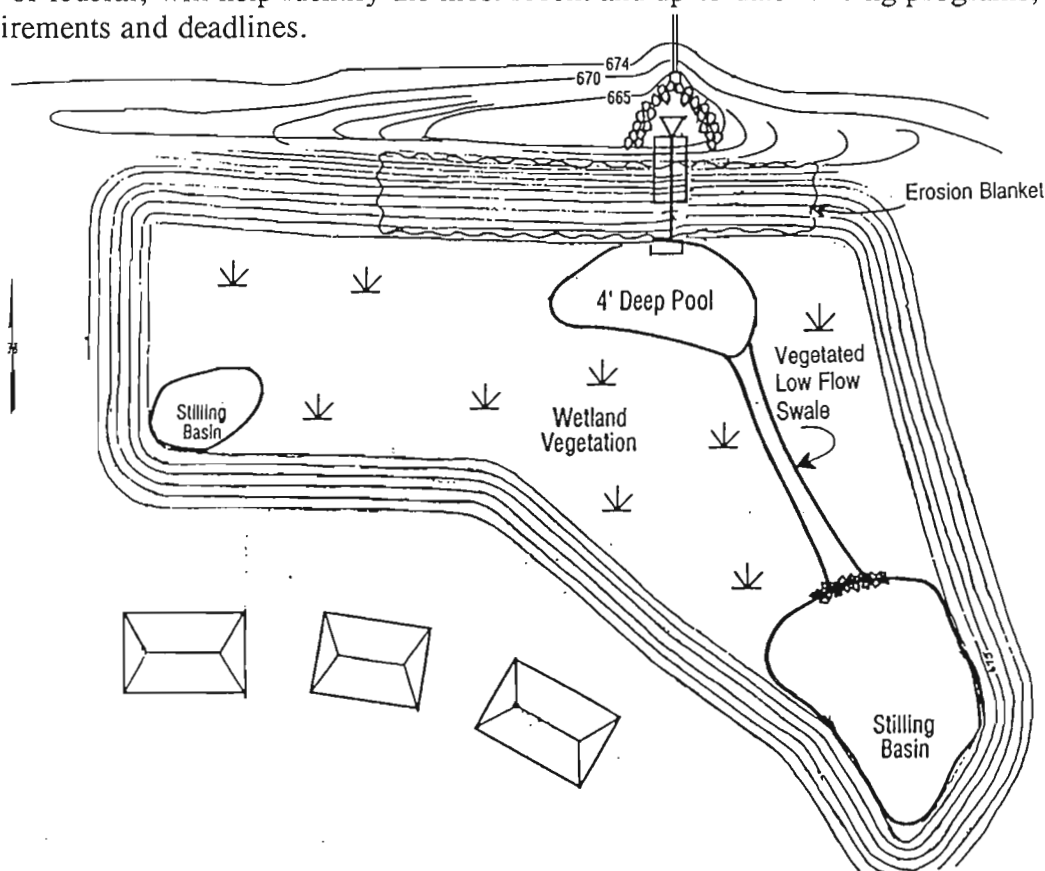

**An example of a detention basin retrofit where the original site does not drain well. Although infiltration is minimal, the retrofit provides longer detention, water quality benefits, and habitat.**

*Flossmoor Stormwater Detention Basin Retrofit, Northeastern Illinois Planning Commission, August, 1995, p. 16.*



## 2. Moving People Out of Harm's Way and Protecting the Floodplain

### a. *Why Restore the Floodplain?*

*"Floodplains occupy a significant portion of the United States. About seven percent, or 178 million acres, of all U.S. land is floodplain, and, of course, the percentages are much higher along the coasts and major rivers, where most of the larger cities are located. Floodplains are lands subject to periodic inundation by hurricanes, storm tides, heavy rains, and spring snow melt. They are lowlands adjoining the channels of rivers, streams, and other watercourses and the shorelines of oceans, lakes and other bodies of water. Floodplains are shaped by water-related, dynamic physical and biological processes and include many of the nations most beautiful landscapes, most productive wetlands, and most fertile soils. They are home to many rare and endangered plants and animals, as well as sites of archeological and historical significance."*<sup>174</sup>

*"In their natural state, floodplains have substantial value. These complex, dynamic systems contribute to the physical and biological support of water resources, living resources, and cultural resources. They provide natural flood and erosion control, help maintain high water quality, and contribute to sustaining groundwater supplies...Proper management of floodplains is important to preserve their value and to reduce loss caused by flooding."*<sup>175</sup>

Floodplains vegetated with trees and shrubs can be four times as effective at retarding flood flows than grassy areas.<sup>176</sup> In addition, naturally vegetated floodplains provide breeding and feeding grounds for both fish and wildlife, they "create and enhance waterfowl habitat", and they "protect habitat for rare and endangered species."<sup>177</sup> Naturally vegetated floodplains are generally layered with leaf and organic matter which result in soils with high porosity and a greater capacity for holding water.<sup>178</sup> The floodplain, in this natural state, is a riparian ecosystem that needs the overbank flows that the natural watershed's hydrology provides in order to remain healthy and in balance.<sup>179</sup>

#### **What is a Floodplain?**

A floodplain is the low, flat, periodically flooded area adjacent to rivers, lakes, and oceans. It is subject to geomorphic (land shaping) and hydrologic (water flow) processes. The floodplain is a sponge that absorbs water, filters it, and helps the captured floodwater to infiltrate through the soil so that the groundwater aquifer below is replenished. A complex physical and biological system, the floodplain and its stream support a variety of natural resources.

*"Beyond Flood Control: Flood Management and River Restoration",  
May, 1997, Friends of the River, Sacramento, CA*



## Floodway Schematic

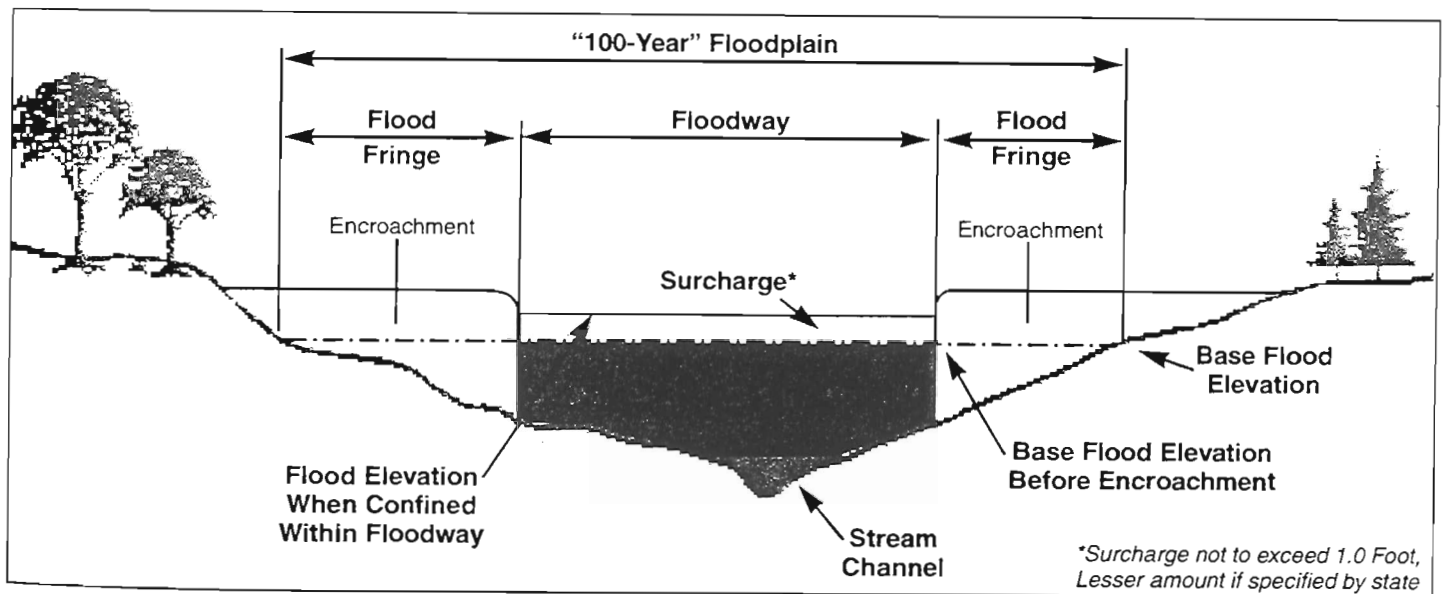

### The Floodplain and Floodway

*Reprinted from Higher Ground, A Report on Voluntary Property Buyouts in the Nation's Floodplains, National Wildlife Federation, July 1998, adapted from John H. McShane, Managing Floodplains to Reduce Flood Losses and Protect Natural Resources, 1993*

#### **b. How the Floodplain Is Regulated**

According to most government agencies, a floodplain is the area along a waterway that is expected to be or has been inundated in a 100-year frequency flood. This means the 100-year flood has a one-in-one-hundred or one percent chance of being equaled or exceeded in any year. The 100-year frequency flood serves as the standard for most regulations. Inside the floodplain is the floodway. The floodway is the most dangerous area of the floodplain and is the most strictly regulated for all obstructions. It is that portion of the channel of a waterway that carries the deeper, faster waters. The delineation of the floodway is established by specific calculations by the Federal Emergency Management Agency (FEMA). State environmental regulations also define and regulate the floodway.<sup>180</sup>

For instance, New Jersey regulates floodplain activity according to a defined flood hazard area which is the 100 year floodplain increased by 25% in the State Adopted Flood Studies. New Jersey also requires that non-delineated streams be calculated by an engineer assuming that the entire contributory drainage area is fully developed as per local zoning. These regulations are aimed at calculating the floodplain limits with the impacts of development included so as not to underestimate future expected flood flows.

Communities that are flood prone are eligible for the National Flood Insurance Program (NFIP) protection. To participate in the NFIP, a municipality must enact regulations that

meet the minimum floodplain management requirements established by FEMA. The federal government puts a lot of energy into trying to get people to purchase flood insurance--from television ads to insurance carrier promotions. Nonetheless, not all property owners in the floodplain take advantage of flood insurance--nationwide, only 1.7 million of 10 million structures in flood prone areas are covered by insurance as of 1996.<sup>181</sup> When disaster funds have been distributed in the past, not all those who benefited were covered by flood insurance.

Construction and development in all areas defined by FEMA as “flood prone” today must be regulated—that is, activity in areas subject to the 100-year flood. Buildings proposed to be built in the 100-year floodplain must either be elevated or floodproofed to or above the elevation of the 100-year flood. This elevation must be established for every activity within the floodplain. How this is done depends on the type of maps and flood information available.<sup>182</sup>

Not all municipalities have been mapped by FEMA. For example, FEMA flood insurance studies have been done in less than half of Pennsylvania’s municipalities (1100 total).<sup>183</sup> However, other maps are available and must be used by the municipality if they do exist: flood hazard boundary maps, flood insurance rate maps, county soil surveys, historic flood data, maps done by the US Army Corps of Engineers, the Natural Resource Conservation Service, the United States Geologic Survey, federal and state environmental agencies and other government departments such as transportation, parks, and community development.

Municipalities that do not comply with FEMA regulations are not eligible for the NFIP and can be denied state funding for several other programs. In Pennsylvania, for instance, they can be taken to civil court by the state to force compliance. This is done for the community's protection and the protection of those downstream.<sup>184</sup> Municipalities can have stricter regulations than the minimum requirements of the NFIP and they also must follow all State regulations such as floodplain management acts and environmental rules. Municipalities that enact stricter requirements than NFIP receive discounts on their flood insurance premiums.<sup>185</sup>

The NFIP defines “development” as “any manmade change to improved or unimproved real estate, including but not limited to buildings or other structures, mining, dredging, filling, grading, paving, excavation, or drilling operations”.<sup>186</sup> The intent of the NFIP regulations and local flood plain management ordinances concerning development in the floodplain is to reduce future flood damages.

But FEMA is not only regulating new floodplain activity. Voluntary buyouts and floodplain restoration has become a national priority for FEMA and other government agencies.<sup>187</sup> The cost of repetitive loss properties being rebuilt in the floodplain with flood insurance monies, even if they are built according to existing flood mapping data, is becoming too expensive and environmentally destructive.

### ***c. New Policies Are Discouraging Floodplain Construction***

The “Galloway Report”, a report issued by a special commission headed by Army Corps of Engineers General Gerald Galloway after the 1993 Midwest floods, found that flood peaks are



increasing in watersheds.<sup>188</sup> The report found that this is because floodplains are being eliminated. In response, the report recommended that regulated floodplains be expanded in order to increase the area along streams in which structures cannot be built. It identified floods as “natural repetitive phenomena” that will continue to occur. The report called for moving people out of risky areas and employing land use planning that recognizes that communities must live with floods rather than try to control them.<sup>189</sup>

### (i) Repetitive Loss Properties

A “repetitive loss target group property” is any property insured under the NFIP that: has had four or more paid flood losses of at least \$1,000 each since 1978; 2 losses within 10 years that, when added together, equal or exceed the current value of the property; 3 or more losses that, when added together, equal or exceed the property's value.<sup>190</sup> Although repetitive loss properties represent only 2% of all properties insured by the NFIP, they account for about 40% of all NFIP payments.<sup>191</sup> According to FEMA, repetitive loss properties will amount to \$200 million each year in claims payouts.<sup>192</sup>

A detailed study by the National Wildlife Federation (NWF) found 300 communities across the nation identified as repetitive loss communities because they contain at least one repetitive loss property.<sup>193</sup> NWF recommends that these communities be given priority for use of voluntary buyout funding from the federal government so that the biggest chunk of flood damages can be eliminated permanently. The most effective way to reduce flood damage is by removing a structure from harm's way. By buying out properties that continually flood, many dollars can be saved AND the stream's floodplain can be restored to the function nature intended—to soak up rain, buffer runoff, and protect streambanks, in-stream and streamside habitats. In fact, the only way that the environmental harm that is caused by floods--the scouring and eroding of streambanks, the destruction of vital habitat that is exposed to the inundation of floodwaters beyond the floodplain--can be eliminated is by allowing the floodplain to function—nature's “best management practice”.

**Recommended Reading:**  
*Higher Ground, A Report on Voluntary Property Buyouts in the Nation's Floodplains, National Wildlife Federation, July 1998*

### (ii) Reclaiming the Floodplain

In human terms, when structures are removed from the floodplain people who may have been exposed to danger are taken out of harm's way. The only sure way to save lives from floods is to get people away from the water's edge and let the river safely inundate the spongy open space nature intended for floodwaters.

In their natural state, floodplains effectively store floodwaters, the vegetation physically reducing flood velocities and peak flow rates. At the same time, floodplains filter out sediment and other pollutants from runoff and promote infiltration and groundwater recharge. Vegetated floodplains provide needed shade to streams thereby moderating instream temperatures for both water quality and habitat benefits.<sup>194</sup> They also provide aesthetic value and opportunity for people to enjoy the enrichment of a protected natural stream corridor.



Development in the floodplain inhibits all of these critical functions. The fill placed in the floodplain reduces the floodplains ability to convey stormwater, thereby increasing upstream flood elevations and increasing the "velocity of water traveling past the reduced flow area."<sup>195</sup>

In "Bucks County Flood Recovery and Mitigation Study" prepared by the Delaware Valley Regional Planning Commission (DVRPC) for the U.S. Department of Commerce, the impervious coverage that has accompanied floodplain development in central and lower Bucks County communities (sub-basin 2, DR) is identified as the cause of increased flood frequency and velocity in the Neshaminy Creek and Delaware River.<sup>196</sup> In 1996, storms and weather conditions led to flood conditions exacerbated by floodplain disturbance, channelization of small feeder creeks, increased stormwater runoff, structures in flood hazard areas, and lack of adequate stormwater controls in the contributing watersheds.

In their study, DVRPC recommends 16 policies for floodplain management by municipalities. The policies favor nonstructural measures that focus on better floodplain management and land use regulations that keep people out of the floodplain and restore stream corridors to natural conditions. The report also recommends that wetlands, the 100-year floodplain, and the flood fringe that buffers the floodplain, should be off-limits to development and that existing structures be removed; and that all development in the watershed should limit impervious cover and increase stormwater infiltration practices so that the amount of total run-off can be reduced, thereby decreasing stormwater and flood flows.

In addition to floodplain regulations and voluntary buyouts, FEMA is developing other ways to reclaim floodplains for waterways. FEMA's newest policies target repetitive loss properties for mitigation. The plan is to require that if a target property is offered mitigation assistance through the Flood Mitigation Assistance Program or the Hazard Mitigation Grant Program and the offer is declined, flood insurance for the property will be renewed or rewritten only at a full-risk premium—ending present government subsidies to these properties.<sup>197</sup> This provides another incentive for homeowners to remove structures from the floodplain -- full-cost flood insurance is very expensive.<sup>198</sup>

Additionally, the Federal Crop Insurance Program has been reformed, limiting disaster assistance and requiring landowners to purchase insurance. This eliminates a subsidy for farming in marginal lands.<sup>199</sup>

The NFIP is beginning to change its rules, as well, as evidenced by changes made in 1994. One big problem with the program is that the premiums charged insurance buyers do not cover the costs of maintaining the program and are subsidized by the government-- 50% of the buildings covered under the NFIP (built before flood insurance) receive a federal rate subsidy of 66%.<sup>200</sup> The program is not actuarially sound -- this means that the payments on each property do not reflect the sums needed to cover anticipated losses.<sup>201</sup> As a result, the insurance program, experiencing heavy claims in recent years, has had to be bailed out by the U.S. Treasury -- in the 1980's by more than \$1 billion<sup>202</sup> and between 1995 and 1998 another \$810 million.<sup>203</sup>



There have been some changes made to NFIP regulations to more accurately reflect the risks involved but effort has also been made to not make flood insurance so expensive (actuarially sound premiums could make insurance skyrocket exponentially) that homeowners will drop it. This would increase the chance of the government having to totally subsidize mitigation with federal disaster funds after a flood.<sup>204</sup> Nonetheless, more reform of the insurance program is coming. As a participant in the 1994 Lincoln Institute of Land Policy conference commented, past NFIP policies amount to "the public subsidy of private folly".<sup>205</sup>

There are other ways to reduce risk other than increasing premiums. FEMA and the NFIP have targeted repetitive loss properties as an effective reform candidate. In FEMA's report on its 1999 National Flood Insurance Conference, Jo Ann Howard, as Administrator for the Federal Insurance Administration of FEMA, likens repetitive loss properties to a bucket with holes in the bottom, saying "We've got to plug some of the repetitive loss holes to make this program financially stable." "We can protect our environment while we prevent flood disasters. We have to rethink home building and community development", said Howard. "We need to use nonstructural methods of flood control, and we must move away from the idea that we can dictate the flow of our waterways and the changes in our shorelines. We need to protect our floodplains as a living, breathing, segment of our world" she stated in "A Message from the Administrator".<sup>206</sup> FEMA has identified 10 million structures with a value of a trillion dollars on 150,000+ square miles in flood prone areas. And for every dollar spent on relocating houses in the floodplain, \$2 in future disaster relief costs is saved.<sup>207</sup>

"Over the last 30 years, average annual riverine flood damages have exceeded \$2 billion. Over the last 10, they have been more than \$3 billion."

*Brigadier General Galloway, The Galloway Report" The Interagency Floodplain Management Task Force, June, 1994*

### **3. Initiatives To Restore the Floodplain**

There is new support for restoring the floodplain by removing all structures and re-vegetating naturally.

✓ One of the projects that has been created by FEMA is Project Impact. Project Impact's goal is to create disaster-resistant communities by building community partnerships that bring together private and public sectors, non-profits and government, and all the various resources of federal and state agencies (in New Jersey, Chevy Chase Bank, the Bank of New York, and Home Depot teamed with FEMA's Project Impact to host its first Disaster Prevention Weekend in October, 1999<sup>208</sup>). Public involvement is seen as key to the success of the program. Project Impact helps a community to identify its vulnerability to hazards and to prioritize hazard risk reduction actions. Funding will, among other things, help municipalities remove structures from the floodplain.<sup>209</sup> The program is working on modernizing FEMA's flood maps, revitalizing FEMA's compliance program, and using the Hazard Mitigation Grant Program to target repetitive loss properties. According to Michael Armstrong, Associate



Director of FEMA's Mitigation Directorate "Mitigation resources have moved 23,000 properties out of the floodplain since 1993 alone. These areas are now dedicated to open space, contributing to the restoration of wetlands and parks and to creating a new sense of safety and quality of life in the floodplain community".<sup>210</sup>

✓ The "Galloway Report", mentioned above, also recommends that repetitive loss outlays be reduced by "adding a surcharge to flood insurance policies following each claim under a policy, providing for mitigation insurance riders, and supporting other mitigation activities".<sup>211</sup> They also recommend giving full consideration to permanent evacuation of flood prone areas.<sup>212</sup>

✓ Another step taken by FEMA is the establishment of the National Dam Safety Program (Section 215, P.L. 104-303, WRDA of 1996). Between 1960 and 1997, 318 people have died as a result of dam failures. During the July 1994 Tropical Storm Alberto, there were more than 200 dam failures in Georgia, killing 15 people.<sup>213</sup> FEMA, working with other federal agencies, is now responsible for coordinating the establishment and maintenance of safe dams throughout the nation in order to reduce dam disasters and related floods.<sup>214</sup>

✓ Challenge 21 is an Army Corps of Engineers authorized project created to fund flood mitigation and riverine restoration. Challenge 21 recognizes the value of nonstructural solutions to flooding problems and the importance of restoring the natural functions and values of rivers. The goals of the project are to restore and improve degraded ecosystems and reduce flood damages along flood-prone streams and rivers. In August of 1999 Challenge 21 was authorized in the Water Resources Act under Section 212. Emphasis will be on preventing and reducing flood damages through non-structural solutions. Buyouts of eligible structures can be funded by the project.<sup>215</sup> In 2001, appropriations up to \$20 million will be available nationally; in 2002, \$30 million; and in 2003, \$50 million.<sup>216</sup> Priority areas were set in the authorization and will be the first areas to be funded. The Upper Delaware River in New York, the Delaware River in Pennsylvania (including the Neshaminy Creek), and the Schuylkill River (a tributary of the Delaware), are included. The program looks to partner with state and local agencies. Delaware Riverkeeper Network nominated the Neshaminy Creek watershed to the Challenge 21 Program for inclusion as a priority watershed in April, 1998 in order to provide needed funding for the buyout of structures in the floodplain that have suffered repeated flood damages. The nomination was accepted by the Army Corps and is expected to receive funding when appropriations are made.

"Those 75,000 dams [in the U.S. today] are the cumulative result of two centuries of innovation and progress, accompanied by indifference to the natural world of river ecology. What started out as reasonable and desirable went on and on beyond all logic, overstating benefits, ignoring the damage to fisheries and river systems, and understating the financial costs...it is time to un-dedicate some of those dams by removing them and letting the rivers run free."

*"A River Runs Against It: America's Evolving View of Dams", Bruce Babbitt, 1.22.01*

✓ In addition to Challenge 21, the Water Resources Act of 1999 re-authorized the Aquatic Ecosystem Restoration Program under Section 210. This program funds the “restoration of degraded aquatic ecosystem system structure, function, and dynamic processes to a less degraded, more natural condition, which involves consideration of the ecosystem’s natural integrity, productivity, stability, and biological diversity”.<sup>217</sup> This project will fund streambank restoration and ecosystem repair in waterways and can be used by municipalities and county or state agencies in cooperation with nonprofit organizations. The Project is funded \$25 million nationwide for each fiscal year.<sup>218</sup>

✓ The US Department of Agriculture's Wetlands Reserve Program buys wetlands from landowners and restores them. The Conservation Reserve Program compensates farmers for avoiding cultivation of sensitive lands--reducing agricultural runoff and soaking up floodwaters. Under the Wetland Reserve Program 665,000 acres of wetlands have been protected and 310,000 more acres are to be bought from farmers by 2001.<sup>219</sup>

✓ Pennsylvania's Growing Greener program is a state funded initiative helping communities implement a variety of stream protection efforts, including protecting open space, restoring riparian lands and streambanks, and in so doing, helping to restore natural function to floodplain areas.

As Dennis S. Mileta states in "Disasters by Design," it is time for the government to stop subsidizing disaster risks. Hazard control structures such as dams do not stop the hazards or eliminate the risks of living in or too close to the floodplain. If such a structure is built, it should be paid for by those who benefit from them--not by the federal government and the tax-paying public at large. Additionally, federal programs should be required to operate on a full cost recovery basis, rather than the commonly used benefit/cost ratio analysis.<sup>220</sup>

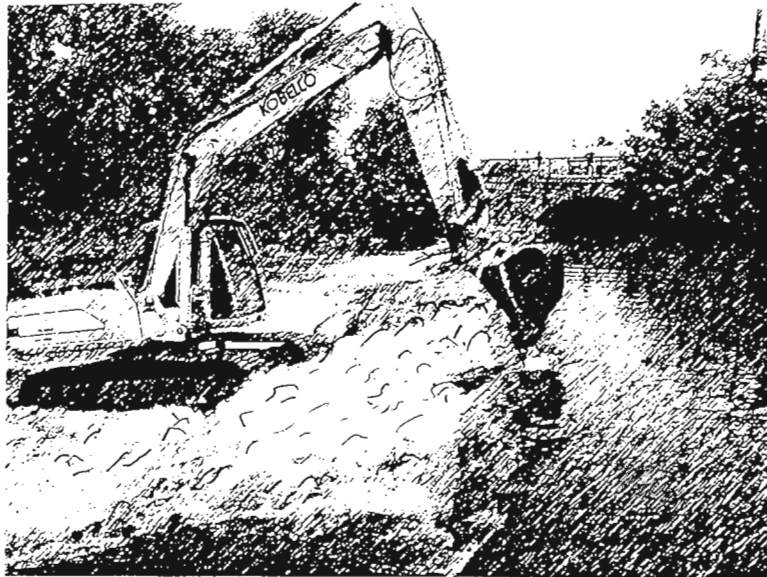

*Initial breach of the orphan dam on Manatawny Creek, Pottstown, PA, August 2000. The Delaware Riverkeeper Network, Greater Pottstown Watershed Alliance and the Academy of Natural Sciences worked and are working together to secure removal of the structure, to restore upstream floodplain, and to monitor impacts to the Manatawny Creek.*

*Photo by J. Lawrence, Delaware Riverkeeper Network*





## Chapter 4: Working on a Watershed Basis

From the 1930's through the 1960's, basin-wide water development projects mainly focused on structural methods for flood control, navigation and water supply. Under President Franklin D. Roosevelt, comprehensive development of river basins was seen as a way to promote social and economic progress.<sup>221</sup> By the '90's, federal and state agencies and local decisionmakers began to re-evaluate traditional engineering approaches for managing stormwater. By the end of the decade, they recognized the need to re-define their policies for managing stormwater.

**Definition:** Watershed -- A watershed is made up of all the land that drains to a waterway.

All the Delaware River watershed states are in the process of making changes in their regulatory and planning processes that support the goals of comprehensive stormwater management.

- ✓ Pennsylvania's 21<sup>st</sup> Century Committee (Executive Order 7.1.97) cited the state's current land-use patterns as the topic of greatest concern, proposing the use of a watershed approach to water resource and stormwater management. The committee recommended that water quality and quantity, surface and groundwater, aquatic ecosystem and natural diversity considerations be incorporated in water resources decisionmaking.<sup>222</sup>



**Delaware River Watershed**  
*Provided by the Delaware River Basin Commission*



- ✓ Delaware has implemented a Whole Basin Approach focusing on a watershed-based approach to decisionmaking that considers, holistically, environment issues, resource issues, and the resulting ramifications and/or benefits of each decision on a wide-range of issues.<sup>223</sup>
- ✓ In New Jersey, the approach is called the Watershed Initiative, dividing the State up into planning areas based on watershed boundaries and is intended to allow for broad-based decisionmaking on a watershed basis.
- ✓ The part of New York State that is in the Delaware River watershed (i.e. drains to the Delaware) is under special protection because its reservoirs supply drinking water to New York City and parts of Connecticut. EPA has mandated that New York develop a more stringent watershed protection program in order to clean up and protect New York City's drinking water.

Experience, science and emerging engineering knowledge are demonstrating that effective stormwater management requires thinking and acting on a watershed basis. That is why the States are changing their approach. Unfortunately, while these plans look good on paper, they are not translating into real world, watershed-based decisionmaking. Development, stormwater, flooding, and water quality issues are still being considered and addressed in a piecemeal fashion.

Today, despite all of the progress in thinking, apolitical, community-driven, watershed-based environmental protection is yet to be truly implemented. For instance, watershed planning to reduce flooding and stormwater is not widely accepted or implemented and new technology, even if it is better and cheaper, is resisted by those who would rather not change, who want to continue doing things the way they have always done them ("business as usual"). The challenge of the new century is to implement, at the watershed level, land use and water management practices that balance, protect and restore the natural world, benefiting all of us dependant on these resources.

## **A. Achieving Multiple Community Objectives Through a Watershed-Based Approach to Stormwater Management**

Watershed-based planning uses the natural boundaries of the drainage area of a stream -- its watershed -- as the defining unit upon which a community plans to manage its water resources, which includes stormwater. Just as adverse environmental impacts need to be considered on a cumulative basis (recognizing that while one pollution discharge alone may not be enough to harm a stream, when combined with others there can be significant damage), stormwater improvements need to be considered cumulatively. A comprehensive approach which includes prevention as well as restoration, can address new and existing stormwater problems, employing a combination of small and large solutions. On a cumulative basis, such a variety of solutions can best address flood, drought, and degraded water quality. A watershed-based approach to stormwater management allows a community to create a comprehensive program, preferably in cooperation with other municipalities in a watershed or sub-basin. Multiple objectives can be met in a coordinated way, rather than municipalities working at cross



purposes when programs are not developed with the entire watershed in mind. Limited financial and community resources can be stretched and the workload shared.

A watershed-based approach also allows communities to choose and implement stormwater programs that address multiple community issues, making best advantage of limited resources and dollars. For example, because the most effective stormwater management techniques rely on preserving nature's ability to infiltrate and cleanse stormwater runoff, a watershed-based approach can also be used to enhance and advance a community's open space program. Addressing stormwater runoff on a watershed basis allows communities to recognize that a reduction in rainfall infiltration also means a reduction in aquifer recharge and an increase in pollution-carrying stormwater runoff. The watershed-based approach also allows communities to work together to accomplish multiple comprehensive stormwater prevention-driven goals: Reduce flooding, including peak rate and total volume of runoff; achieve water quality objectives including achieving regulatory requirements; maintain a balanced hydrologic cycle and water budget; ensure adequate aquifer recharge and drinking water supplies; protect open space resources and unique natural features; improve traffic calming measures; provide effective visual and sound buffers for communities; protect creeks, wildlife and aquatic habitats; and address other community quality of life issues.

## **B. Achieving Regulatory Requirements Through a Watershed-based Approach to Stormwater Management**

A comprehensive, watershed-based approach to stormwater can also help communities achieve new and emerging regulatory requirements.

### **1. TMDLs**

Implementation of the Clean Water Act is today forcing further clean up of our streams, wetlands, bays and rivers -- a goal which will require action at every level of government, especially the local level. Today the states must identify those waterways that still fail to meet state water quality standards despite the technology-based controls and permit limits that have been placed on point source (end of pipe) discharges. Pursuant to section 303 of the Clean Water Act, these streams, identified as impaired, are put on the state's 303(d) list and become the subject of "Total Maximum Daily

#### **TMDLs**

After putting into place technology-based controls on point source pollution discharges, the Clean Water Act requires a second strategy. Section 303 of the Act requires states to establish water quality standards for waterways and then to identify those streams failing to meet the standards. Streams identified as impaired are put on the state's 303(d) list and become the subject of "Total Daily Maximum Loads" (TMDLs) regulations. A TMDL calculates the maximum amount of an offending pollutant the stream can receive -- from all sources including from a pipe, off the land or from the air -- and still meet water quality standards. The allowable pollution load (TMDL) is then allocated amongst all pollution contributors -- point and non-point.

The Delaware Riverkeeper Network brought suit to enforce these provisions of the Clean Water Act in PA, DE and NJ.



Load" (TMDL) regulations. A TMDL calculates the maximum amount of an offending pollutant the stream can receive -- from all sources (discharging from a pipe, running off of the land and settling from the air) -- and still meet water quality standards. The allowable pollution load (TMDL) is then allocated out amongst all pollution contributors -- point and non-point. Because nonpoint source pollution is a primary pollution source for most of this region's streams, a tremendous level of energy will necessarily be focused on reducing these pollution contributors.

Because stormwater best management practices improve water quality and include the most effective measures for addressing stormwater runoff-induced non point source pollution, implementing a comprehensive stormwater management program will help communities meet their obligations under section 303 of the Clean Water Act. At a minimum, using best management practices will not contribute further to an existing water quality problem, a claim that more conventional approaches to stormwater management cannot make.

EPA regulations now require an implementation plan to be part of every new TMDL. For many if not most waterways, the implementation plan will likely be focused on nonpoint source pollution contributors and municipalities will have a major role to play in achieving the TMDL requirements. Therefore, utilizing every opportunity to implement infiltration practices and other best management practices will help communities accomplish this regulatory burden.

## **2. NPDES II**

Since 1990 the Clean Water Act has required (1) "municipal separate storm sewer systems" (referred to as MS4s) serving populations of 100,000 or more, (2) several categories of industrial activity, and (3) developers of construction sites of 5 or more acres are required to develop and implement stormwater plans under Phase I of the National Pollution Discharge Elimination System (NPDES) stormwater regulations.<sup>224</sup> Effective February, 2000, regulations implementing Section 402(p) of the Federal Clean Water Act are now requiring smaller municipalities and developments to obtain pollution discharge permits for their stormwater discharges.<sup>225</sup> According to the new regulations NPDES permits are also now required for both municipal separate storm sewer systems (MS4s) serving less than 100,000 persons that are located in urbanized areas, and construction sites that disturb one to five acres.<sup>226</sup> In addition, the State can identify other sources that are not automatically regulated if they are contributing to an actual or potential exceedence of water quality standards including impairment of designated uses or other adverse impacts on water quality as a result of this stormwater discharge.<sup>227</sup>

Pursuant to the NPDES permit program all regulated MS4s will have to develop and implement a storm water management program that at a minimum includes: public education and outreach, public involvement, illicit discharge detection and elimination, construction site runoff control, post-construction stormwater management in new development and redevelopment, pollution

***For More Information:***

[www.epa.gov/owm/sw/phase2](http://www.epa.gov/owm/sw/phase2)



prevention and good housekeeping of municipal operations. A regulated MS4 must submit with its permit application or notice of intent the best management practices to be implemented and the measurable goals for each of the minimum control measures listed previously. The EPA is encouraging the use of conservation design practices, best management practices and infiltration in fulfilling the permit requirements.<sup>228</sup>

### C. Implementing Watershed-based Planning

Conventional planning fails to recognize that stormwater runoff is a lost resource—the rain that should have recharged groundwater and fed base flow to surface water is being diverted instead through pipes and channels to waterways during and immediately following each rainfall. The first step in developing a watershed-based plan for a community is to account for all the components of a watershed's resources. The second is realizing how to both protect and carefully utilize those resources, maintaining their balance.

By utilizing watershed-based planning, stormwater management is achieved at the planning level, using various tools for measuring how to best achieve the balance needed to prevent stormwater runoff and protect water resources.<sup>229</sup> Using a watershed approach for stormwater control allows consideration of where growth should occur. It allows for a greater awareness of the cumulative impacts of development and other land use activities. It allows related issues such as aquifer recharge to be included in the planning stages and addressed more effectively, and it provides a basis for decisionmaking that can be defended against attack.<sup>230</sup>

Watershed-based planning can be achieved by a mix of methods tailored to each community. The level of watershed protection to be achieved is in great measure defined by existing land use and stream water quality. For example, in order to maintain existing high water quality, such as in specially designated streams under State and Federal protection (i.e. exceptional value and high quality streams; federal wild and scenic river designated portions of the Delaware River and tributary streams) higher standards must be set and stricter land use controls are necessary. For these sensitive watersheds, the following how-to's can make watershed-based planning successful:<sup>231</sup>

- ✓ limiting impervious cover to a maximum of 8-10% of a watershed;
- ✓ infiltration BMPs should be employed to maintain/restore the hydrologic balance;
- ✓ all BMPs employed should preserve natural areas, protect the natural stream network and minimize environmental impacts;
- ✓ wide stream valley reserves should be used as buffers for stream corridors, ponds and wetlands;
- ✓ surface waters should be monitored closely for trends in fish and aquatic insect diversity and/or indicator species (i.e. trout, certain macroinvertebrates);
- ✓ planning and enforcement should be accomplished through careful tracking of impervious cover percentages (i.e. aerial surveys);
- ✓ analysis of biological and physical stream monitoring and conscientious maintenance of BMPs; and



- ✓ the employment of a variety of creative protection strategies such as purchase of development rights, open space purchase, unique feature preservation, and cluster development.

A watershed-based community-driven planning approach known as Integrated Resource Planning is being employed in parts of the Delaware River watershed today. The Delaware River Basin Commission (DRBC) is encouraging Integrated Resource Plans (IRPs) to be used in the development of groundwater resource management plans in their Southeastern Groundwater Protected Zone. This planning approach is based on the sub-basin level of a watershed rather than political boundaries and involves all stakeholders, including the public.<sup>232</sup> Neighboring municipalities located within a watershed join forces to study and plan for the protection of the water resource. The plan is implemented through coordinated efforts and ordinances that protect the whole resource rather than just the piece within their municipal boundaries. The result is regulations that not only better protect a community's resources, but which are also more defensible against legal challenge.

In Pennsylvania, Act 167 requires counties to create watershed-based stormwater management plans for all of the State's waterways. Municipalities and other watershed stakeholders (e.g. conservation associations) are invited to participate on a watershed planning advisory committee which guides the creation of the plan and the policies it embodies. Once complete, all municipalities, with financial support from the Pennsylvania Department of Environmental Protection, are required to bring their stormwater ordinances into compliance with the completed plan within six months. It is critical that citizens and municipalities ensure that Act 167 Plans allow them to use the most effective approaches to address stormwater runoff quantity and quality issues, including BMPs and infiltration.

## D. How to Encourage use of Stormwater Infiltration and Best Management Practices in Watershed Planning

The water quality and quantity benefits provided through use of stormwater BMPs should be enough to persuade communities that they must be used. But BMPs are also a more economical approach to stormwater management. "By using BMPs, rather than more traditional systems, development and stormwater infrastructure costs can be lowered."<sup>233</sup>

Because the developer saves money by replacing pipes, basins, and other hard infrastructure with a BMP, BMPs are proving to be economically attractive. Sometimes less land is needed when a huge detention basin can be eliminated and replaced with an integrated BMP. And well-constructed BMP

**BMPs cost less and save money**  
An existing sand filter at Air Pegasus Airport, MD, was retrofitted to include a bio-retention area that captured additional runoff from the site not previously addressed. This saved the airport \$25,000 in infrastructure costs and provided water quality benefits.

*"Low Impact Development Management Strategies for Wet Weather Flow Control," Neil Weinstein, presented at Delaware Sediment and Stormwater Program Conference 2000, October 24, 2000.*



systems should be less expensive in the long run, especially for the community at large. For example, BMPs will reduce downstream sediment loads, thereby reducing the need for sediment removal from waterways and ponds. BMPs that stabilize runoff rates will minimize downstream flooding and bank erosion and all the costs associated with the damage these cause.<sup>234</sup>

There are a number of incentives communities can use to encourage the use of BMPs, some examples include:

- ✓ User fees for stormwater management -- i.e. assessing fees against stormwater generators for the stormwater functions municipalities carry out such as storm sewers, street sweeping, and maintenance of storm systems.
- ✓ Have mitigation requirements for the development of natural open space.
- ✓ Direct subsidies to developers who allow community costs to be lowered by the reduction of flood damages, dredging and other problems avoided downstream.

A good local example of an incentive program is the Chester County Pennsylvania Conservation District's policy that provides a 25% reduction of review fees charged to projects that utilize preferred Best Management Practices for Erosion Control and Stormwater Management. PADEP reported the program in its "Update", December, 2000 (Vol. 6, No. 46), praising the District for its innovative approach.

Private homeowners should be educated to understand that they have a critical role to play in implementing best management practices and reducing stormwater runoff. For example, directing rooftop runoff to pervious areas like yards, open channels, and other vegetated areas rather than storm conveyance systems and roadways -- this enhances infiltration, allowing aquifer recharge and providing water quality benefits. Sending rooftop runoff over a pervious surface before it reaches an impervious surface can decrease annual runoff volume from residential development sites by as much as 50%.<sup>235</sup> Other options include: replacing lawns with vegetated areas and small woodlands; a vegetated buffer around lawns that can capture and infiltrate lawn stormwater runoff; and rain barrels that prevent runoff and capture rainfall for use during dry periods.







*Watersheds need . . .  
less sediment;*



*less floodplain development.*



*Watersheds need . . .*



*more  
healthy  
streams.*



## Chapter 5: Municipal Regulations: "The Force is With You"

This handbook has explored a wide variety of techniques, technologies, regulatory options and planning tools that can accomplish the goal of effective stormwater management. The handbook in its entirety is intended to provide information and tools that communities and citizens can use to improve stormwater management at the local level. This chapter is intended to review some ways that use of stormwater BMPs can be encouraged through the municipal planning process. It is not an exhaustive discussion of options, but when coupled with previous chapters, provides an important base of understanding and information.

Municipalities have power. In the Delaware River watershed, municipalities are invested with tremendous powers to control their destiny. Unfortunately, there are powerful forces that seek to work against municipalities exercising their strength. While there is some support from the States, such as funding for watershed planning and stormwater planning, the final implementation of how a community wants to plan its future lies with the municipality. And the municipality's most potent tool is regulation.

Municipalities should have specialized stormwater ordinances. In order to accomplish this, the municipality's master plan or comprehensive plan must call for effective and comprehensive stormwater management as essential to the community goal of water resource protection. Throughout the master plan the importance of protecting water resources, permeable soils, open space and vegetative cover should be addressed. The plan should clearly state that, wherever feasible, stormwater runoff should be managed on site using stormwater best management practices that mimic natural infiltration.

Appendix B includes a sample stormwater ordinance that encourages and supports use of stormwater infiltration and best management practices.

The municipality's land use regulations should repeat the goals and recommendations of the master plan regarding stormwater infiltration, minimization of impervious cover, protection of vegetated areas, open space and water resources. "Most communities rely on zoning, subdivision and wetland regulations to control land use" but these land use regulations can also be used to address imperviousness and stormwater runoff in a variety of ways such as:<sup>236</sup>

- ✓ Prohibit or limit uses that pose hazards to water quality;
- ✓ Zoning that encourages development in areas capable of supporting it and discouraging development in areas unsuitable to sustain it;
- ✓ Use open space/cluster design approaches to development;
- ✓ Limit the amount of lot coverage and define impervious cover to include buildings, roads, sidewalks, parking areas, compacted earth and piping;

- ✓ Include stormwater management and infiltration in special permit decisionmaking;
- ✓ Effective erosion and sediment control regulations with inspection and enforcement funded by developer fees;
- ✓ Stormwater management regulations that address the impacts of development and runoff on both water quality and quantity;
- ✓ Restrict earth removal and site disturbance and require that topsoil be maintained on site;
- ✓ Aquifer and wellhead protection zones should be mapped and protected from proposed development;
- ✓ Prohibit development within the floodplain;
- ✓ Establish a stream corridor buffer zone of at least 100 feet beyond the 100-year floodplain where development activities are restricted.

Regulations are being adopted in the State of Maryland that encourage the developer to use best management practices by allowing credits to be awarded to meet stormwater management requirements on a development site. By providing this organized incentive, the municipality can spur the employment of BMPs since the developer can then reduce the amount of funds that must be invested in stormwater management on the site. Appendix C contains a chapter on Stormwater Credits from the Maryland BMP Manual detailing this concept.

Another example of incentives for the use of BMPs is Chester County (PA) Conservation District's policy initiative that provides a 25% reduction of review fees charged for projects that utilize BMPs for erosion control and stormwater management. Other tools such as overlay protection zones, slope restrictions, and transfer or purchase of development rights can all be used to help protect natural resources and address issues associated with stormwater runoff.<sup>257</sup>

As with zoning, subdivision development regulations must also be used to achieve the goals included in the master plan. Stormwater management plans must focus to the greatest extent possible on minimizing stormwater runoff, controlling it onsite, and infiltrating it when appropriate both in design and during construction.<sup>258</sup>

The amount of impervious coverage can effectively be used as a land use planning tool because the relationship between impervious cover and both water quantity and quality is well-documented and impervious cover is measurable.<sup>259</sup>

Municipalities should institute regulations for redevelopment projects as well. Redevelopment sites should be required to restore stormwater peak flow and volume to pre-development levels for the 2-year storm. And BMPs can be retrofitted to many suburban and urban settings.



A site imperviousness goal should be set (10% is currently being used by many municipalities but research shows that water quality impacts can be found with as little as 4% impervious surface) for development sites. Incentives and disincentives can be used to encourage developers to minimize site imperviousness, even below the established goal. Some ideas include: if the set goal/limit is exceeded, then more stringent on-site stormwater treatment becomes required;<sup>240</sup> a utility rate structure for stormwater could be established based on the level of imperviousness of a site; the cost of treatment of stormwater runoff by municipal storm sewer systems can be distributed according to the property's contribution to runoff.<sup>241</sup>

Municipalities need to recognize the powerful opportunities local authority affords them. Federal and State requirements can never achieve the level of protection needed by our communities and our environment without implementation at the local level.





---

## Endnotes

- <sup>1</sup> National Wildlife Federation, Higher Ground. A Report on Voluntary Property Buyouts in the Nation's Floodplains, July 1998
- <sup>2</sup> "Flood Policy and Flood Management: A Post-Galloway Progress Report", River Voices, Vol8, No. 2, Summer, 1997
- <sup>3</sup> DNREC and Brandywine Conservancy, Conservation Design for Stormwater Management: A Design Approach to Reduce Stormwater Impacts from Land Development and Achieve Multiple Objectives Related to Land Use, September, 1997, p. 1-17
- <sup>4</sup> Bruce K. Ferguson, Stormwater Infiltration, CRC Press, 1994, p. 31
- <sup>5</sup> Personal communications with Cahill Associates, West Chester, PA, 1999-2000
- <sup>6</sup> Poff, Allan, Bain, Karr, Prestergaard, Richter, Sparks, and Stromberg, "The Natural Flow Regime", BioScience, Vol. 47, No. 11
- <sup>7</sup> DNREC and Brandywine Conservancy, Conservation Design for Stormwater Management: A Design Approach to Reduce Stormwater Impacts from Land Development and Achieve Multiple Objectives Related to Land Use, September, 1997 ; Impervious Surface Coverage, the Emergence of a Key Environmental Indicator, by Chester L. Arnold Jr., and C. James Gibbons, APA Journal, Spring 1996
- <sup>8</sup> DNREC and Brandywine Conservancy, Conservation Design for Stormwater Management: A Design Approach to Reduce Stormwater Impacts from Land Development and Achieve Multiple Objectives Related to Land Use, September, 1997, p. 1-17
- <sup>9</sup> Bruce K. Ferguson, Stormwater Infiltration, CRC Press, 1994, p. 165
- <sup>10</sup> DNREC and Brandywine Conservancy, Conservation Design for Stormwater Management: A Design Approach to Reduce Stormwater Impacts from Land Development and Achieve Multiple Objectives Related to Land Use, September, 1997, p. 1-17; and Bruce K. Ferguson, Stormwater Infiltration, CRC Press, 1994, p 25
- <sup>11</sup> Bruce K. Ferguson, Stormwater Infiltration, CRC Press, 1994, p.25.
- <sup>12</sup> Bruce K. Ferguson, Stormwater Infiltration, CRC Press, 1994, p. 165
- <sup>13</sup> DNREC and Brandywine Conservancy, Conservation Design for Stormwater Management: A Design Approach to Reduce Stormwater Impacts from Land Development and Achieve Multiple Objectives Related to Land Use, September, 1997, p. 1-16
- <sup>14</sup> J. Broughton and S. Apfelbaum, "Using Ecological Systems for Alternative Stormwater Management", Land and Water, Sept/Oct, 1999
- <sup>15</sup> NRDC, Stormwater Strategies, 1999 on Hollis, G.E., "The Effect of Urbanization on Floods of Different Recurrence Interval", Water Resources Research, vol.11, no.3, June 1975, p.434
- <sup>16</sup> J. Broughton and S. Apfelbaum, "Using Ecological Systems for Alternative Stormwater Management", Land and Water, Sept/Oct, 1999
- <sup>17</sup> National Wildlife Federation, Higher Ground. A Report on Voluntary Property Buyouts in the Nation's Floodplains, July 1998
- <sup>18</sup> National Wildlife Federation, Higher Ground. A Report on Voluntary Property Buyouts in the Nation's Floodplains, July 1998
- <sup>19</sup> National Wildlife Federation, Higher Ground. A Report on Voluntary Property Buyouts in the Nation's Floodplains, July 1998
- <sup>20</sup> National Wildlife Federation, Higher Ground. A Report on Voluntary Property Buyouts in the Nation's Floodplains, July 1998
- <sup>21</sup> Thomas Scheuller, Controlling Urban Runoff. a Practical Manual for Planning and Designing Urban BMP's, Dept. of Urban Programs Metropolitan Washington Council on Governments, 1987.
- <sup>22</sup> Pennsylvania Handbook of Best Management Practices for Developing Areas, Prepared by CH2MHILL, Spring 1998, p. 6-2
- <sup>23</sup> Stormwater Management Systems, Porous Pavement System with Underground Recharge Beds, Engineering Design Report, Cahill Associates, Spring, 1993
- <sup>24</sup> Cahill and Associates Environmental Consultants, Porous Pavement with Underground Recharge Beds, Spring, 1993
- <sup>25</sup> "How Much Development is Too Much for Streams, Rivers, Lakes, Tidal Waters and Wetlands?", Community and Environmental Defense Services, Maryland Line, MD





- <sup>26</sup> "How Much Development is Too Much for Streams, Rivers, Lakes, Tidal Waters and Wetlands?", Community and Environmental Defense Services, Maryland Line, MD
- <sup>27</sup> "How Much Development is Too Much for Streams, Rivers, Lakes, Tidal Waters and and Wetlands?", Community and Environmental Defense Services, Maryland Line, MD
- <sup>28</sup> DNREC and Brandywine Conservancy, Conservation Design for Stormwater Management: A Design Approach to Reduce Stormwater Impacts from Land Development and Achieve Multiple Objectives Related to Land Use, September, 1997, p. 1-18
- <sup>29</sup> National Wildlife Federation Fact Sheet -- [nwf.org/wetlands/facts/benefits.html](http://nwf.org/wetlands/facts/benefits.html)
- <sup>30</sup> Clean Water Network and NRDC, "Wetlands for Clean Water, How Wetlands Protect Rivers, Lakes and Coastal Waters from Pollution", April 1997
- <sup>31</sup> Clean Water Network and NRDC, "Wetlands for Clean Water, How Wetlands Protect Rivers, Lakes and Coastal Waters from Pollution", April 1997
- <sup>32</sup> Clean Water Network and NRDC, "Wetlands for Clean Water, How Wetlands Protect Rivers, Lakes and Coastal Waters from Pollution", April 1997
- <sup>33</sup> USEPA, America's Wetlands, Our Vital Link Between Land and Water, Feb. 1988, Doc. # OPA-87-016, p. 6.
- <sup>34</sup> "Providing Wetlands for Wildlife While Controlling Stormwater", Penn State College of Agriculture Cooperative Extension, Circular #384; National Wildlife Federation Fact Sheet, [nwf.org/wetlands/facts/statfct.html](http://nwf.org/wetlands/facts/statfct.html), citing "Status and Trends of Wetlands in the Conterminous United States: Projected Trends 1985 to 1995", Sept. 17, 1997, by US Fish and Wildlife Service.
- <sup>35</sup> Managing Nonpoint Source Pollution, Final Report to Congress on Section 319 of the Clean Water Act, USEPA, 1992, p.24
- <sup>36</sup> Clean Water Network and NRDC, "Wetlands for Clean Water, How Wetlands Protect Rivers, Lakes and Coastal Waters from Pollution", April 1997
- <sup>37</sup> "Protecting Natural Wetlands; A Guide to Stormwater Best Management Practices", USEPA, October, 1996
- <sup>38</sup> Cahill Associates, "Stormwater Best Management Practices, Land Use Management for Nonpoint Source Control in the Lower Delaware Coastal Zone", 1993; New York State Department of Environmental Conservation, Reducing the Impacts of Stormwater Runoff from New Development, April, 1992; DNREC and Brandywine Conservancy, Conservation Design for Stormwater Management: A Design Approach to Reduce Stormwater Impacts from Land Development and Achieve Multiple Objectives Related to Land Use, September, 1997
- <sup>39</sup> Center for Watershed Protection, Better Site Design: A Handbook for Changing Development Rules in Your Community, August, 1998
- <sup>40</sup> New York State Department of Environmental Conservation, Reducing the Impacts of Stormwater Runoff from New Development, April, 1992
- <sup>41</sup> Arnold and Gibbons, "Impervious Surface Coverage, the Emergence of a Key Environmental Indicator", APA Journal, Spring 1996, p. 245
- <sup>42</sup> EPA, "Pointer No. 7, Managing Urban Runoff", Nonpoint Pointers fact sheet, March 1996, EPA-841-F-96-004G
- <sup>43</sup> Widener Environmental and Natural Resources Law Clinic analysis, 1999; EPA Office of Water, National Water Quality Inventory: 1998 Report to Congress, [www.epa.gov/305b/98report/nj.html](http://www.epa.gov/305b/98report/nj.html).
- <sup>44</sup> Report of the Pennsylvania 21<sup>st</sup> Century Environment Commission, September, 1998, p. 43; EPA Office of Water, National Water Quality Inventory: 1998 Report to Congress, [www.epa.gov/305b/98report/pa.html](http://www.epa.gov/305b/98report/pa.html).
- <sup>45</sup> Widener Environmental and Natural Resources Law Clinic analysis, 1999; EPA Office of Water, National Water Quality Inventory: 1998 Report to Congress, [www.epa.gov/305b/98report/de.html](http://www.epa.gov/305b/98report/de.html).
- <sup>46</sup> New York State Department of Environmental Conservation, Reducing the Impacts of Stormwater Runoff from New Development, April, 1992, Table 3
- <sup>47</sup> "Stormwatch", Vortech, Fall, 1998
- <sup>48</sup> Center for Watershed Protection, Better Site Design: A Handbook for Changing Development Rules in Your Community, August, 1998
- <sup>49</sup> Arnold and Gibbons, "Impervious Surface Coverage, the Emergence of a Key Environmental Indicator", APA Journal, Spring 1996, citing Klein, 1979; Griffin, 1980; Schueler 1987; Todd 1989; Schueler 1992; Booth and Reinfelt, 1993; Schueler 1994a
- <sup>50</sup> Arnold and Gibbons, "Impervious Surface Coverage, the Emergence of a Key Environmental Indicator", APA Journal, Spring 1996, p. 245
- <sup>51</sup> "How Much Development is Too Much for Streams, Rivers, Lakes, Tidal Waters and Wetlands?", Community and Environmental Defense Services, Maryland Line, MD



- <sup>52</sup> Arnold and Gibbons, "Impervious Surface Coverage, the Emergence of a Key Environmental Indicator", *APA Journal*, Spring 1996
- <sup>53</sup> "Urban Stormwater Runoff: Working for Clean Water", Pa State University and USEPA
- <sup>54</sup> "Urban Stormwater Runoff: Working for Clean Water", Pa State University and USEPA
- <sup>55</sup> "Stormwater Management and Nonpoint Source Pollution Control in the Delaware Estuary Drainage" Delaware Estuary Program, USEPA
- <sup>56</sup> Bruce K. Ferguson, Stormwater Infiltration, CRC Press, 1994, book preface p. 1.
- <sup>57</sup> Bruce K. Ferguson, Stormwater Infiltration, CRC Press, 1994, p. 3-4.
- <sup>58</sup> Broughton and Apfelbaum, "Using Ecological Systems for Alternative Stormwater Management", Land and Water, 1999
- <sup>59</sup> Bruce K. Ferguson, Stormwater Infiltration, CRC Press, 1994, p. 3-4.
- <sup>60</sup> Bruce K. Ferguson, Stormwater Infiltration, CRC Press, 1994, p. 3-4.
- <sup>61</sup> Bruce K. Ferguson, Stormwater Infiltration, CRC Press, 1994, p. 152-153.
- <sup>62</sup> Bruce K. Ferguson, Stormwater Infiltration, CRC Press, 1994, p. 155,; New York State Department of Environmental Conservation, Reducing the Impacts of Stormwater Runoff from New Development, April, 1992
- <sup>63</sup> Cahill Associates, prepared for NJDEP, Stormwater Management in the New Jersey Coastal Zone, April 1989
- <sup>64</sup> DNREC and Brandywine Conservancy, Conservation Design for Stormwater Management: A Design Approach to Reduce Stormwater Impacts from Land Development and Achieve Multiple Objectives Related to Land Use, September, 1997, p. 1-26
- <sup>65</sup> DNREC and Brandywine Conservancy, Conservation Design for Stormwater Management: A Design Approach to Reduce Stormwater Impacts from Land Development and Achieve Multiple Objectives Related to Land Use, September, 1997, p. 1-26
- <sup>66</sup> DNREC and Brandywine Conservancy, Conservation Design for Stormwater Management: A Design Approach to Reduce Stormwater Impacts from Land Development and Achieve Multiple Objectives Related to Land Use, September, 1997, p. 1-26
- <sup>67</sup> DNREC and Brandywine Conservancy, Conservation Design for Stormwater Management: A Design Approach to Reduce Stormwater Impacts from Land Development and Achieve Multiple Objectives Related to Land Use, September, 1997, p. 1-26
- <sup>68</sup> DNREC and Brandywine Conservancy, Conservation Design for Stormwater Management: A Design Approach to Reduce Stormwater Impacts from Land Development and Achieve Multiple Objectives Related to Land Use, September, 1997, p. 3-5
- <sup>69</sup> DNREC and Brandywine Conservancy, Conservation Design for Stormwater Management: A Design Approach to Reduce Stormwater Impacts from Land Development and Achieve Multiple Objectives Related to Land Use, September, 1997, p. 3-3
- <sup>70</sup> Bruce K. Ferguson, Stormwater Infiltration, CRC Press, 1994, p. 177.
- <sup>71</sup> Dawn Nighman, "Infiltration Practices for Flood Control", Land and Water, March/April 1999
- <sup>72</sup> Bruce K. Ferguson, Stormwater Infiltration, CRC Press, 1994, p. 158
- <sup>73</sup> Bruce K. Ferguson, Stormwater Infiltration, CRC Press, 1994, p. 168.
- <sup>74</sup> Northeastern Illinois Planning Commission, "Reducing the Impacts of Urban Runoff: The Advantages of Alternative Site Design Approaches", April, 1997, p. 27
- <sup>75</sup> Northeastern Illinois Planning Commission, "Reducing the Impacts of Urban Runoff: The Advantages of Alternative Site Design Approaches", April, 1997, p. 27
- <sup>76</sup> Thomas Scheuller, Controlling Urban Runoff, a Practical Manual for Planning and Designing Urban BMP's, Dept. of Urban Programs Metropolitan Washington Council on Governments, 1987.
- <sup>77</sup> DNREC and Brandywine Conservancy, Conservation Design for Stormwater Management: A Design Approach to Reduce Stormwater Impacts from Land Development and Achieve Multiple Objectives Related to Land Use, September, 1997, p. 4-24, 25, 28
- <sup>78</sup> DNREC and Brandywine Conservancy, Conservation Design for Stormwater Management: A Design Approach to Reduce Stormwater Impacts from Land Development and Achieve Multiple Objectives Related to Land Use, September, 1997, p. 4-24, 25, 28
- <sup>79</sup> Dawn Nighman, "Infiltration Practices for Flood Control", Land and Water, March/April, 1999; DNREC and Brandywine Conservancy, Conservation Design for Stormwater Management: A Design Approach to Reduce Stormwater Impacts from Land Development and Achieve Multiple Objectives Related to Land Use, September, 1997
- <sup>80</sup> Dawn Nighman, "Infiltration Practices for Flood Control", Land and Water, March/April, 1999



- 
- <sup>81</sup> DNREC and Brandywine Conservancy, Conservation Design for Stormwater Management: A Design Approach to Reduce Stormwater Impacts from Land Development and Achieve Multiple Objectives Related to Land Use, September, 1997, p. 2-28
- <sup>82</sup> Dawn Nighman, "Infiltration Practices for Flood Control", Land and Water, March/April, 1999
- <sup>83</sup> DNREC and Brandywine Conservancy, Conservation Design for Stormwater Management: A Design Approach to Reduce Stormwater Impacts from Land Development and Achieve Multiple Objectives Related to Land Use, September, 1997, p. 2-28
- <sup>84</sup> DNREC and Brandywine Conservancy, Conservation Design for Stormwater Management: A Design Approach to Reduce Stormwater Impacts from Land Development and Achieve Multiple Objectives Related to Land Use, September, 1997, p. 2-28
- <sup>85</sup> DNREC and Brandywine Conservancy, Conservation Design for Stormwater Management: A Design Approach to Reduce Stormwater Impacts from Land Development and Achieve Multiple Objectives Related to Land Use, September, 1997, p. 2-28
- <sup>86</sup> DNREC and Brandywine Conservancy, Conservation Design for Stormwater Management: A Design Approach to Reduce Stormwater Impacts from Land Development and Achieve Multiple Objectives Related to Land Use, September, 1997, p. 2-28
- <sup>87</sup> DNREC and Brandywine Conservancy, Conservation Design for Stormwater Management: A Design Approach to Reduce Stormwater Impacts from Land Development and Achieve Multiple Objectives Related to Land Use, September, 1997 ;Infiltration Practices for Flood Control, Land and Water Magazine, March/April 1999
- <sup>88</sup> Dawn Nighman, "Infiltration Practices for Flood Control", Land and Water, March/April 1999.
- <sup>89</sup> DNREC and Brandywine Conservancy, Conservation Design for Stormwater Management: A Design Approach to Reduce Stormwater Impacts from Land Development and Achieve Multiple Objectives Related to Land Use, September, 1997, p. 2-28 ;Infiltration Practices for Flood Control, Land and Water Magazine, March/April 1999; Personal communication with Cahill Associates, 8/15/00.
- <sup>90</sup> Personal communication, J. Boyle, NJ Geologic Survey, Spring, 2000
- <sup>91</sup> DNREC and Brandywine Conservancy, Conservation Design for Stormwater Management: A Design Approach to Reduce Stormwater Impacts from Land Development and Achieve Multiple Objectives Related to Land Use, September, 1997, p. 2-23
- <sup>92</sup> DNREC and Brandywine Conservancy, Conservation Design for Stormwater Management: A Design Approach to Reduce Stormwater Impacts from Land Development and Achieve Multiple Objectives Related to Land Use, September, 1997, p. 2-27
- <sup>93</sup> Dawn Nighman, "Infiltration Practices for Flood Control", Land and Water, March/April, 1999; Bruce K. Ferguson, Stormwater Infiltration, CRC Press, 1994, p. 180 & 185.
- <sup>94</sup> Pennsylvania Handbook of Best Management Practices for Developing Areas, Prepared by CH2MHILL, Spring 1998, p. 4-1
- <sup>95</sup> DNREC and Brandywine Conservancy, Conservation Design for Stormwater Management: A Design Approach to Reduce Stormwater Impacts from Land Development and Achieve Multiple Objectives Related to Land Use, September, 1997, p. 1-24
- <sup>96</sup> Brown and Schueler for Chesapeake Research Consortium, "The Economics of Stormwater BMP's in the Mid-Atlantic Region", 1997
- <sup>97</sup> DNREC and Brandywine Conservancy, Conservation Design for Stormwater Management: A Design Approach to Reduce Stormwater Impacts from Land Development and Achieve Multiple Objectives Related to Land Use, September, 1997, p. 3-2
- <sup>98</sup> DNREC and Brandywine Conservancy, Conservation Design for Stormwater Management: A Design Approach to Reduce Stormwater Impacts from Land Development and Achieve Multiple Objectives Related to Land Use, September, 1997, p. 4-24 - 4-25
- <sup>99</sup> Horner, "Conservation Design: Managing Stormwater Through Maximizing Preventative Nonstructural Practices", 1999
- <sup>100</sup> DNREC and Brandywine Conservancy, Conservation Design for Stormwater Management: A Design Approach to Reduce Stormwater Impacts from Land Development and Achieve Multiple Objectives Related to Land Use, September, 1997
- <sup>101</sup> DNREC and Brandywine Conservancy, Conservation Design for Stormwater Management: A Design Approach to Reduce Stormwater Impacts from Land Development and Achieve Multiple Objectives Related to Land Use, September, 1997



- 
- <sup>102</sup> Arnold and Gibbons, "Impervious Surface Coverage, the Emergence of a Key Environmental Indicator", APA Journal, Spring 1996, p. 254, citing Burchell, Dolphin and Moskowitz, 1995
- <sup>103</sup> New Jersey State Development and Redevelopment Plan, prepared by New Jersey State Planning Commission, July 12, 1992.
- <sup>104</sup> Bruce K. Ferguson, Stormwater Infiltration, CRC Press, 1994, p. 36.
- <sup>105</sup> Arnold and Gibbons, "Impervious Surface Coverage, the Emergence of a Key Environmental Indicator", APA Journal, Spring 1996
- <sup>106</sup> DNREC and Brandywine Conservancy, Conservation Design for Stormwater Management: A Design Approach to Reduce Stormwater Impacts from Land Development and Achieve Multiple Objectives Related to Land Use, September, 1997, p. 2-33
- <sup>107</sup> Pennsylvania Handbook of Best Management Practices for Developing Areas, Prepared by CH2MHILL, Spring 1998, p. 3-6
- <sup>108</sup> Cahill Associates, Stormwater Management Systems, Porous Pavement System with Underground Recharge Beds, Engineering Design Report, Spring, 1993, p. 9
- <sup>109</sup> DNREC and Brandywine Conservancy, Conservation Design for Stormwater Management: A Design Approach to Reduce Stormwater Impacts from Land Development and Achieve Multiple Objectives Related to Land Use, September, 1997
- <sup>110</sup> DNREC and Brandywine Conservancy, Conservation Design for Stormwater Management: A Design Approach to Reduce Stormwater Impacts from Land Development and Achieve Multiple Objectives Related to Land Use, September, 1997, p. 4-16
- <sup>111</sup> DNREC and Brandywine Conservancy, Conservation Design for Stormwater Management: A Design Approach to Reduce Stormwater Impacts from Land Development and Achieve Multiple Objectives Related to Land Use, September, 1997, p. 3-37
- <sup>112</sup> Center for Watershed Protection, Better Site Design: A Handbook for Changing Development Rules in Your Community, August, 1998, p. 123.
- <sup>113</sup> Pennsylvania Handbook of Best Management Practices for Developing Areas, Prepared by CH2MHILL, Spring 1998
- <sup>114</sup> DNREC and Brandywine Conservancy, Conservation Design for Stormwater Management: A Design Approach to Reduce Stormwater Impacts from Land Development and Achieve Multiple Objectives Related to Land Use, September, 1997, Horner 3-57
- <sup>115</sup> Pennsylvania Handbook of Best Management Practices for Developing Areas, Prepared by CH2MHILL, Spring 1998
- <sup>116</sup> DNREC and Brandywine Conservancy, Conservation Design for Stormwater Management: A Design Approach to Reduce Stormwater Impacts from Land Development and Achieve Multiple Objectives Related to Land Use, September, 1997, p. X
- <sup>117</sup> Center for Watershed Protection, Better Site Design: A Handbook for Changing Development Rules in Your Community, August, 1998
- <sup>118</sup> DNREC and Brandywine Conservancy, Conservation Design for Stormwater Management: A Design Approach to Reduce Stormwater Impacts from Land Development and Achieve Multiple Objectives Related to Land Use, September, 1997, p. 2-32
- <sup>119</sup> DNREC and Brandywine Conservancy, Conservation Design for Stormwater Management: A Design Approach to Reduce Stormwater Impacts from Land Development and Achieve Multiple Objectives Related to Land Use, September, 1997, p. 2-33
- <sup>120</sup> Pennsylvania Handbook of Best Management Practices for Developing Areas, Prepared by CH2MHILL, Spring 1998, p. 3-2
- <sup>121</sup> Pennsylvania Handbook of Best Management Practices for Developing Areas, Prepared by CH2MHILL, Spring 1998, p. 3-2
- <sup>122</sup> DNREC and Brandywine Conservancy, Conservation Design for Stormwater Management: A Design Approach to Reduce Stormwater Impacts from Land Development and Achieve Multiple Objectives Related to Land Use, September, 1997, p. 1-4
- <sup>123</sup> Center for Watershed Protection, Rapid Watershed Planning Handbook, October, 1998
- <sup>124</sup> Pennsylvania Handbook of Best Management Practices for Developing Areas, Prepared by CH2MHILL, Spring 1998, p. 3-6
- <sup>125</sup> Center for Watershed Protection, Site Planning for Urban Stream Protection, co-published by the Metropolitan Washington Council of Governments, December 1995



- <sup>126</sup> "America's Wetlands, Our Vital Link Between Land and Water", US EPA Office of Wetlands Protection, Office of Water, Doc. No. OPA-87-016, February 1988, p. 4
- <sup>127</sup> DNREC and Brandywine Conservancy, Conservation Design for Stormwater Management: A Design Approach to Reduce Stormwater Impacts from Land Development and Achieve Multiple Objectives Related to Land Use, September, 1997, p. 2-11.
- <sup>128</sup> "America's Wetlands, Our Vital Link Between Land and Water", US EPA Office of Wetlands Protection, Office of Water, Doc. No. OPA-87-016, February 1988, p. 4
- <sup>129</sup> "America's Wetlands, Our Vital Link Between Land and Water", US EPA Office of Wetlands Protection, Office of Water, Doc. No. OPA-87-016, February 1988, p. 4
- <sup>130</sup> DNREC and Brandywine Conservancy, Conservation Design for Stormwater Management: A Design Approach to Reduce Stormwater Impacts from Land Development and Achieve Multiple Objectives Related to Land Use, September, 1997, p. 2-12
- <sup>131</sup> "America's Wetlands, Our Vital Link Between Land and Water", US EPA Office of Wetlands Protection, Office of Water, Doc. No. OPA-87-016, February 1988, p. 4.
- <sup>132</sup> DNREC and Brandywine Conservancy, Conservation Design for Stormwater Management: A Design Approach to Reduce Stormwater Impacts from Land Development and Achieve Multiple Objectives Related to Land Use, September, 1997, p. 2-12
- <sup>133</sup> "America's Wetlands, Our Vital Link Between Land and Water", US EPA Office of Wetlands Protection, Office of Water, Doc. No. OPA-87-016, February 1988, p. 4
- <sup>134</sup> "America's Wetlands, Our Vital Link Between Land and Water", US EPA Office of Wetlands Protection, Office of Water, Doc. No. OPA-87-016, February 1988, p.1.
- <sup>135</sup> Michael J. Caduto, Pond and Brook. A Guide to Nature in Freshwater Environments, University Press of New England, 1985
- <sup>136</sup> Center for Watershed Protection, Nutrient Loading from Conventional and Innovative Site Development, July, 1998
- <sup>137</sup> DNREC and Brandywine Conservancy, Conservation Design for Stormwater Management: A Design Approach to Reduce Stormwater Impacts from Land Development and Achieve Multiple Objectives Related to Land Use, September, 1997, p. 4-24 & 4-25
- <sup>138</sup> Bret Rappaport and Joanne Wolfe, "Development Makes Dollars and Sense, Innovative Developments Pioneer Ecological and Cost Saving Landscaping", Professional Wildscaping, special issue 1998
- <sup>139</sup> Center for Watershed Protection, Nutrient Loading from Conventional and Innovative Site Development, July, 1998
- <sup>140</sup> NRDC, Stormwater Strategies, 1999
- <sup>141</sup> DNREC and Brandywine Conservancy, Conservation Design for Stormwater Management: A Design Approach to Reduce Stormwater Impacts from Land Development and Achieve Multiple Objectives Related to Land Use, September, 1997, p. 4-28
- <sup>142</sup> Center for Watershed Protection, Better Site Design: A Handbook for Changing Development Rules in Your Community, August, 1998, p. 147.
- <sup>143</sup> David Welsh, "Riparian Forest Buffers, Functions and Design for Protection and Enhancement of Water Resources," Prepared for the USDA Forest Service, NA-PR-07-91.
- <sup>144</sup> Center for Watershed Protection, Better Site Design: A Handbook for Changing Development Rules in Your Community, August, 1998, p. 35
- <sup>145</sup> Pennsylvania Handbook of Best Management Practices for Developing Areas, Prepared by CH2MHILL, Spring 1998, p. 3-7
- <sup>146</sup> "How Much Development is Too Much for Streams, Rivers, Lakes, Tidal Waters and Wetlands?", Community and Environmental Defense Services, Maryland Line, MD
- <sup>147</sup> NRDC, Stormwater Strategies, 1999
- <sup>148</sup> NRDC, Stormwater Strategies, 1999, p. 82
- <sup>149</sup> DNREC and Brandywine Conservancy, Conservation Design for Stormwater Management: A Design Approach to Reduce Stormwater Impacts from Land Development and Achieve Multiple Objectives Related to Land Use, September, 1997
- <sup>150</sup> Center for Watershed Protection, Better Site Design: A Handbook for Changing Development Rules in Your Community, August, 1998, p. 144



- 
- <sup>151</sup> DNREC and Brandywine Conservancy, Conservation Design for Stormwater Management: A Design Approach to Reduce Stormwater Impacts from Land Development and Achieve Multiple Objectives Related to Land Use, September, 1997, p. 3-36
- <sup>152</sup> DNREC and Brandywine Conservancy, Conservation Design for Stormwater Management: A Design Approach to Reduce Stormwater Impacts from Land Development and Achieve Multiple Objectives Related to Land Use, September, 1997, p. 3-37
- <sup>153</sup> DNREC and Brandywine Conservancy, Conservation Design for Stormwater Management: A Design Approach to Reduce Stormwater Impacts from Land Development and Achieve Multiple Objectives Related to Land Use, September, 1997, p. 3-37
- <sup>154</sup> Center for Watershed Protection, Site Planning for Urban Stream Protection, co-published by the Metropolitan Washington Council of Governments, December 1995
- <sup>155</sup> J. Broughton and S. Apfelbaum, "Using Ecological Systems for Alternative Stormwater Management", Land and Water, Sept/Oct, 1999
- <sup>156</sup> "Urban Stormwater Runoff: Working for Clean Water", Pa State University and USEPA
- <sup>157</sup> EPA, "Pointer No. 7, Managing Urban Runoff", Nonpoint Pointers fact sheet, March 1996, EPA-841-F-96-004G
- <sup>158</sup> Pennsylvania Handbook of Best Management Practices for Developing Areas, Prepared by CH2MHILL, Spring 1998, p. 6-3
- <sup>159</sup> Pennsylvania Handbook of Best Management Practices for Developing Areas, Prepared by CH2MHILL, Spring 1998, p. 6-3
- <sup>160</sup> Cahill and Associates Environmental Consultants, Porous Pavement with Underground Recharge Beds, Spring, 1993
- <sup>161</sup> Arnold and Gibbons, "Impervious Surface Coverage, the Emergence of a Key Environmental Indicator", APA Journal, Spring 1996
- <sup>162</sup> "Developing Successful Runoff Control Programs for Urbanized Areas", EPA 841-K-94-003, August, 1994
- <sup>163</sup> "Developing Successful Runoff Control Programs for Urbanized Areas", EPA 841-K-94-003, August, 1994
- <sup>164</sup> Pennsylvania Handbook of Best Management Practices for Developing Areas, Prepared by CH2MHILL, Spring 1998, p. 6-3 to 6-4
- <sup>165</sup> Pennsylvania Handbook of Best Management Practices for Developing Areas, Prepared by CH2MHILL, Spring 1998, p. 6-3 to 6-4
- <sup>166</sup> Pennsylvania Handbook of Best Management Practices for Developing Areas, Prepared by CH2MHILL, Spring 1998, p. 6-3 to 6-4
- <sup>167</sup> Pennsylvania Handbook of Best Management Practices for Developing Areas, Prepared by CH2MHILL, Spring 1998, p. 6-3 to 6-4
- <sup>168</sup> Pennsylvania Handbook of Best Management Practices for Developing Areas, Prepared by CH2MHILL, Spring 1998, p. 6-3 to 6-4
- <sup>169</sup> Pennsylvania Handbook of Best Management Practices for Developing Areas, Prepared by CH2MHILL, Spring 1998, p. 6-3 to 6-4
- <sup>170</sup> Schueler, "Mitigating the Adverse Impacts of Urbanization on Streams: A Comprehensive Strategy for Local Governments", Washington Council of Governments, DELEP
- <sup>171</sup> DNREC and Brandywine Conservancy, Conservation Design for Stormwater Management: A Design Approach to Reduce Stormwater Impacts from Land Development and Achieve Multiple Objectives Related to Land Use, September, 1997, p. 2-23
- <sup>172</sup> "Developing Successful Runoff Control Programs for Urbanized Areas", EPA 841-K-94-003, August, 1994
- <sup>173</sup> "Developing Successful Runoff Control Programs for Urbanized Areas", EPA 841-K-94-003, August, 1994
- <sup>174</sup> Kusler and Larson, "Beyond the Ark, A New Approach to U.S. Floodplain Management". Reprinted from River Voices, River Network, Portland, OR, Winter, 1994, from an article originally printed I Environment, Vol. 35, No. 5, June 1993
- <sup>175</sup> Kusler and Larson, "Beyond the Ark, A New Approach to U.S. Floodplain Management". Reprinted from River Voices, River Network, Portland, OR, Winter, 1994, from an article originally printed I Environment, Vol. 35, No. 5, June 1993
- <sup>176</sup> DNREC and Brandywine Conservancy, Conservation Design for Stormwater Management: A Design Approach to Reduce Stormwater Impacts from Land Development and Achieve Multiple Objectives Related to Land Use, September, 1997, p. 2-15



- <sup>177</sup> DNREC and Brandywine Conservancy, Conservation Design for Stormwater Management: A Design Approach to Reduce Stormwater Impacts from Land Development and Achieve Multiple Objectives Related to Land Use, September, 1997, p. 2-15
- <sup>178</sup> DNREC and Brandywine Conservancy, Conservation Design for Stormwater Management: A Design Approach to Reduce Stormwater Impacts from Land Development and Achieve Multiple Objectives Related to Land Use, September, 1997, p. 2-15
- <sup>179</sup> Poff, Allan, Bain, Karr, Prestergaard, Richter, Sparks, and Stromberg, "The Natural Flow Regime", BioScience, Vol. 47, No. 11
- <sup>180</sup> "Technical Information on Floodplain Management, Administrative Guidelines for Development, Planning Series 11", Department of Community and Economic Development, Commonwealth of Pennsylvania
- <sup>181</sup> Scott Faber, "On Borrowed Land: Public Policies for Floodplains", Lincoln Institute of Land Policy, 1996
- <sup>182</sup> "Technical Information on Floodplain Management, Administrative Guidelines for Development, Planning Series 11", Department of Community and Economic Development, Commonwealth of Pennsylvania
- <sup>183</sup> "Technical Information on Floodplain Management, Administrative Guidelines for Development, Planning Series 11", Department of Community and Economic Development, Commonwealth of Pennsylvania
- <sup>184</sup> "Technical Information on Floodplain Management, Administrative Guidelines for Development, Planning Series 11", Department of Community and Economic Development, Commonwealth of Pennsylvania
- <sup>185</sup> "Technical Information on Floodplain Management, Administrative Guidelines for Development, Planning Series 11", Department of Community and Economic Development, Commonwealth of Pennsylvania
- <sup>186</sup> "Technical Information on Floodplain Management, Administrative Guidelines for Development, Planning Series 11", Department of Community and Economic Development, Commonwealth of Pennsylvania
- <sup>187</sup> "Sharing the Challenge: Floodplain Management into the 21<sup>st</sup> Century—A Report of the Interagency Floodplain Management Review Committee to the Administration Floodplain Management Task Force", Washington, D.C., June 1994
- <sup>188</sup> "Sharing the Challenge: Floodplain Management into the 21<sup>st</sup> Century—A Report of the Interagency Floodplain Management Review Committee to the Administration Floodplain Management Task Force", Washington, D.C., June 1994; As reported in "Beyond Flood Control: Flood Management and River Restoration", Friends of the River, Sacramento, CA, May, 1997.
- <sup>189</sup> "Sharing the Challenge: Floodplain Management into the 21<sup>st</sup> Century—A Report of the Interagency Floodplain Management Review Committee to the Administration Floodplain Management Task Force", Washington, D.C., June 1994; As reported in "Beyond Flood Control: Flood Management and River Restoration", Friends of the River, Sacramento, CA, May, 1997.
- <sup>190</sup> "NFIP Program Changes", NFIP Watermark, FEMA, Spring/Summer, 2000
- <sup>191</sup> National Wildlife Federation, Higher Ground, A Report on Voluntary Property Buyouts in the Nation's Floodplains, July 1998
- <sup>192</sup> "Climbing to New Heights", NFIP Watermark, FEMA, Spring/Summer, 1999
- <sup>193</sup> National Wildlife Federation, Higher Ground, A Report on Voluntary Property Buyouts in the Nation's Floodplains, July 1998
- <sup>194</sup> DNREC and Brandywine Conservancy, Conservation Design for Stormwater Management: A Design Approach to Reduce Stormwater Impacts from Land Development and Achieve Multiple Objectives Related to Land Use, September, 1997, p. 2-14
- <sup>195</sup> DNREC and Brandywine Conservancy, Conservation Design for Stormwater Management: A Design Approach to Reduce Stormwater Impacts from Land Development and Achieve Multiple Objectives Related to Land Use, September, 1997, p. 2-14
- <sup>196</sup> Bucks County Flood Recovery and Mitigation Strategy, Delaware Valley Regional Planning Commission, September, 1998
- <sup>197</sup> "How Will the NFIP Repetitive Loss Strategy Affect You?", Watermark, FEMA, Spring/Summer, 1999
- <sup>198</sup> "How Will the NFIP Repetitive Loss Strategy Affect You?", Watermark, FEMA, Spring/Summer, 1999
- <sup>199</sup> Scott Faber, "Flood Policy and Management: A Post-Galloway Progress Report", River Voices, Summer, 1997
- <sup>200</sup> David Conrad, National Wildlife Federation, "National Flood Insurance Program; A Critical River Protection Tool in Need of Reform", River Voices, Winter 1994, p.6
- <sup>201</sup> National Wildlife Federation, Higher Ground, A Report on Voluntary Property Buyouts in the Nation's Floodplains, July 1998



- 202 David Conrad, National Wildlife Federation, "National Flood Insurance Program; A Critical River Protection Tool in Need of Reform", River Voices, Winter 1994, p.6
- 203 National Wildlife Federation, Higher Ground. A Report on Voluntary Property Buyouts in the Nation's Floodplains, July 1998
- 204 National Wildlife Federation, Higher Ground. A Report on Voluntary Property Buyouts in the Nation's Floodplains, July 1998
- 205 Alice Ingerson, Lincoln Institute of Land Policy, "Executive Summary", "On Borrowed Land: Public Policies for Floodplains", 1996, p.1
- 206 National Flood Insurance Program, Watermark, FEMA, Spring/Summer, 1999
- 207 Bob Schuldren, "Unnatural Disasters", Sierra, May/June 1999
- 208 "Smart Rebuilding Saves Lives and Property", New Jersey Disaster Recovery, NJ Office of Emergency Management, 10.11.99, p.5
- 209 "Project Impact: Building a Disaster Resistant Community", FEMA Workbook and Video Kit
- 210 "Climbing to New Heights", NFIP Watermark, FEMA, Spring/Summer, 1999.
- 211 "Sharing the Challenge: Floodplain Management into the 21<sup>st</sup> Century—A Report of the Interagency Floodplain Management Review Committee to the Administration Floodplain Management Task Force", Washington, D.C., June 1994
- 212 "Sharing the Challenge: Floodplain Management into the 21<sup>st</sup> Century—A Report of the Interagency Floodplain Management Review Committee to the Administration Floodplain Management Task Force", Washington, D.C., June 1994
- 213 "Partnering for Mitigation—The National Dam Safety Program", Watermark, FEMA, Spring/Summer, 1999
- 214 "Partnering for Mitigation—The National Dam Safety Program", Watermark, FEMA, Spring/Summer, 1999
- 215 Water Resources Act, 1999
- 216 Personal Communication with Paul Guadini, U.S. Army Corps of Engineers, Philadelphia District, September 3, 1999
- 217 "Corps of Engineers Environmental Restoration Program", U.S. Army Corps of Engineers
- 218 Water Resources Act, 1999
- 219 Bob Schuldren, "Unnatural Disasters", Bob Schuldren, Sierra, May/June 1999
- 220 Dennis S. Mileti, Disasters by Design. A Reassessment of Natural Hazards in the United States, 1999, p. 282
- 221 Scott Faber, "On Borrowed Land: Public Policies for Floodplains", Lincoln Institute of Land Policy, 1996
- 222 Pennsylvania's Nonpoint Source Management Program 1998 Update, PADEP
- 223 Butch Kinerney, "Oh, How They Can Harmonize", Fall 1996 Outdoor Delaware
- 224 National Pollutant Discharge Elimination System -- Regulations for Revision of the Water Pollution Control Program Addressing Storm Water Discharges, 40 CFR Parts 9, 122, 123 and 124. Final rule issued December 8, 1999
- 225 National Pollutant Discharge Elimination System -- Regulations for Revision of the Water Pollution Control Program Addressing Storm Water Discharges, 40 CFR Parts 9, 122, 123 and 124. Final rule issued December 8, 1999
- 226 National Pollutant Discharge Elimination System -- Regulations for Revision of the Water Pollution Control Program Addressing Storm Water Discharges, 40 CFR Parts 9, 122, 123 and 124. Final rule issued December 8, 1999
- 227 National Pollutant Discharge Elimination System -- Regulations for Revision of the Water Pollution Control Program Addressing Storm Water Discharges, 40 CFR Parts 9, 122, 123 and 124. Final rule issued December 8, 1999
- 228 National Pollutant Discharge Elimination System -- Regulations for Revision of the Water Pollution Control Program Addressing Storm Water Discharges, 40 CFR Parts 9, 122, 123 and 124. Final rule issued December 8, 1999
- 229 DNREC and Brandywine Conservancy, Conservation Design for Stormwater Management: A Design Approach to Reduce Stormwater Impacts from Land Development and Achieve Multiple Objectives Related to Land Use, September, 1997, p. 3-2
- 230 DNREC and Brandywine Conservancy, Conservation Design for Stormwater Management: A Design Approach to Reduce Stormwater Impacts from Land Development and Achieve Multiple Objectives Related to Land Use, September, 1997, p. X-ii
- 231 Center for Watershed Protection, Site Planning for Urban Stream Protection, co-published by the Metropolitan Washington Council of Governments, December 1995





- 
- <sup>232</sup> Delaware River Basin Commission, Ground Water Protected Area Regulations, Amendment dated January 20, 1998
- <sup>233</sup> Pennsylvania Handbook of Best Management Practices for Developing Areas, Prepared by CH2MHILL, Spring 1998, p. 4-5
- <sup>234</sup> Pennsylvania Handbook of Best Management Practices for Developing Areas, Prepared by CH2MHILL, Spring 1998, p. 4-6
- <sup>235</sup> Center for Watershed Protection, Better Site Design: A Handbook for Changing Development Rules in Your Community, August, 1998, p. 125
- <sup>236</sup> Jim Gibbons, Univ of Connecticut Cooperative Extension, "Addressing Imperviousness in Plans, Site Design and Land Use Regulations"
- <sup>237</sup> Jim Gibbons, Univ of Connecticut Cooperative Extension, "Addressing Imperviousness in Plans, Site Design and Land Use Regulations"
- <sup>238</sup> Jim Gibbons, Univ of Connecticut Cooperative Extension, "Addressing Imperviousness in Plans, Site Design and Land Use Regulations"
- <sup>239</sup> Jim Gibbons, Univ of Connecticut Cooperative Extension, "Addressing Imperviousness in Plans, Site Design and Land Use Regulations"
- <sup>240</sup> Chester L. Arnold Jr., and C. James Gibbons, "Impervious Surface Coverage, the Emergence of a Key Environmental Indicator", APA Journal, Spring 1996, p. 255
- <sup>241</sup> Chester L. Arnold Jr., and C. James Gibbons, "Impervious Surface Coverage, the Emergence of a Key Environmental Indicator", APA Journal, Spring 1996



## APPENDIX A

### NATIVE PLANTS: WHAT ARE THEY AND WHERE CAN I FIND THEM?





## **NATIVE PLANTS: WHAT ARE THEY AND WHERE CAN I FIND THEM?**

### **WHAT IS NATIVE?**

A native plant is defined as one which occurred within a specific area before settlement by Europeans. Plants native to the Delaware River watershed include: ferns and clubmosses; grasses, sedges, and rushes; flowering perennials, annuals, and biennials; and of course, woody trees, shrubs and vines.

Native plant communities are influenced by their physiographic region. Geologic formations are responsible for the types of soils found in the region. Soil types provide the foundation of local plant communities as well as the entire ecosystem.

### **WHY PLANT NATIVE?**

Native plants evolved in harmony with their ecosystems, and as a result need less care, use fewer resources and have a higher survival rate. They also provide diverse habitat for wildlife, attracting and providing food for a variety of birds, small mammals and amphibious creatures throughout the year. As a result, native plants ensure that our local ecosystems are more stable and more productive.

Native plants along streamside lands create a buffer area. These buffer areas protect water quality through a natural filtration system that removes pollutants before they can enter our streams. A plant's woody stems and roots help to decrease flooding by slowing the velocity of rushing flood waters and allowing an opportunity for storage and infiltration. Mature root systems also help to stabilize streambanks by keeping the soil in place, which helps to control erosion. Tree canopies shade the water and cool the temperature, which improves the aquatic habitat.

### **WHERE TO PLANT NATIVES?**

One approach to planting natives is to consider plant communities. A plant community is a system of interrelated plants, animals, water and soil. Plant communities throughout the country vary greatly based on climate. Within each region, factors that define a plant community are precipitation, light, temperature, elevation and soil.





## NATIVE PLANT INDEX

PLANTS IN THIS APPENDIX ARE LISTED FIRST BY PLANT TYPE AND THEN LISTED ALPHABETICALLY BY THEIR BOTANIC NAME. A COMMON NAME CROSS REFERENCE LIST IS ALSO INCLUDED AT THE END.

PLANTS LISTED INCLUDE: FERNS, GRASSES, HERBACEIOUS PERENNIALS, SHRUBS, TREES, AND VINES.

### MOISTURE REQUIREMENTS

OBL	OBLIGATE	Found in wetlands 99% of the time
FACW	FACULTATIVE WET	Found in wetlands 67-99% of the time
FAC	FACULTATIVE	Found in wetlands 34-66% of the time
FACU	FACULTATIVE UPLAND	Found in wetlands 1-33% of the time
UPL	UPLAND	Found in wetlands less than 1% of the time

### LIGHT REQUIREMENTS

- SUN
- ◐-PART SHADE
- SHADE

### \* COLUMN

AN \* SIGNIFIES PLANTS THAT ARE SUITABLE FOR STREAMSIDE RIPARIAN AREAS.

### SOME NATIVE PLANT SUPPLIERS

Every Spring the **Delaware Riverkeeper Network** has a native plant sale. Give us a call at 215-369-1188 for details.

In the Spring and Fall the **Bowman's Hill Wildflower Preserve** has a native plant sale. Call them at 215-862-2924 for details.

#### **Nurseries Include:**

Arrowwood Nursery, Inc – Williamstown, NJ  
Ernst Conservation Seeds – Meadville, PA  
Hopewell Nursery – Boyertown, PA  
North Creek Nursery – Landenderg, PA  
Octoraro Wetland Nursery – Kirkwood, PA  
Pinelands – Columbus, NJ  
Russell Gardens Nursery – Richboro, PA  
Temple Univ. Ambler- Native Plant Center  
Wild Earth – Freehold, NJ

Appalachian Nurseries, Inc. – Wayneboro, PA  
Conard-Pyle Co. - West Grove, PA  
David Brothers Nursery – Worcester, PA  
Langscapes at Shire Meadows – Glenmore, PA  
Musser Forests, Inc. – Indiana, PA  
Natural Landscapes – West Grove, PA  
Sanwil Native Plant Nursery – Harleysville, PA



BOTANIC NAME	COMMON NAME	FAMILY NAME	FLOWER	BLOOM TIME	SUN LIGHT	MOISTURE *	DISTINGUISHING CHARACTERISTICS
<b>FERNS</b>							
<i>Dryopteris goldiana</i>	Goldie's wood fern	Wood Fern Family	N/A	N/A	►●	FAC +	Big bold fern; easy to grow
<i>Mateucia struthiopteris</i>	Ostrich fern	Wood Fern Family	N/A	N/A	○►	FACW	Huge fronds; extremely stately
<i>Onoclea sensibilis</i>	Sensitive fern	Wood Fern Family	N/A	N/A	○●	FACW	Will form a complete cover; beautiful dried fertile fronds
<i>Osmunda cinnamomea</i>	Cinnamon fern	"Flowering" Fern Family	N/A	N/A	○●	FACW	Cinnamon-colored fertile fronds
<i>Osmunda claytoniana</i>	Interrupted fern	"Flowering" Fern Family	N/A	N/A	►●	FAC	Grows in clumps; distinctive fronds
<i>Osmunda regalis</i>	Royal fern	"Flowering" Fern Family	N/A	N/A	○●	OBL	Fronds resemble locust leaves; beautiful when mature
<b>GRASSES &amp; SEDGES</b>							
<i>Andropogon gerardii</i>	Big bluestem	Grass Family	Yellow	Aug-Sep	○	FAC	Tall clump forming 4-6'; attractive, with winter interest
<i>Andropogon virginicus</i>	Broom sedge	Grass Family	Silvery seed head	Sep	○	FACU	Upland meadow grass
<i>Calamagrostis canadensis</i>	Blue joint grass	Grass Family	Brown	Aug-Sep	○►	FACW +	Wetland meadow grass
<i>Carex stricta</i>	Tussock sedge	Sedge Family	Brown	May-Aug	○►	OBL	* Forms hummock mound; bog turtle habitat
<i>Panicum virgatum</i>	Switch grass	Grass Family	Blue-green	Aug-Sep	○	FAC	Clump grass; can help to control erosion
<i>Schizachyrium scoparium</i>	Little bluestem	Grass Family	Purple seed head	Jul-Sep	○	FACU	Clump grass; tolerates poor soil; winter interest
<i>Schoenoplectus tabernaemontani</i>	Softstemmed bulrush	Sedge Family	Brown	Jun-Aug	○	OBL	* Tall upright spikes
<i>Scirpus cyperinus</i>	Wool grass	Sedge Family	reddish brown	Jul-Sep	○	FACW	* Tall wet meadow grass with wooly seed head
<i>Sorghastrum nutans</i>	Indian grass	Grass Family	Yellow	Aug-Sep	○	UPL	Clump grass; tall with beautiful seed heads



BOTANIC NAME	COMMON NAME	FAMILY NAME	FLOWER	BLOOM TIME	SUN LIGHT	MOISTURE	DISTINGUISHING CHARACTERISTICS
<b>HERBACEOUS PERENNIALS</b>							
<i>Aquilegia canadensis</i>	Columbine	Buttercup Family	Red-orange	Spring	►-●	UPL	Commonly cultivated; spreads by seed; hummingbirds
<i>Arisaema triphyllum</i>	Jack-in-the-pulpit	Arum Family	Green-purple	Apr-Jun	►-●	FACW-	Unusual flower; bright red berries; woodland plant
<i>Arnica dioica</i>	Goatsbeard	Rose Family	White	Jul-Aug	►-●	FACU	Showy plumes; does well in filtered shade
<i>Asarum canadense</i>	Wild ginger	Pipe Vine Family	Maroon	Apr-May	●	UPL	Herbal uses; shady groundcover
<i>Asclepias incarnata</i>	Swamp milkweed	Milkweed Family	Rose	July-Aug	○	OBL	* Attracts butterflies
<i>Asclepias tuberosa</i>	Butterfly weed	Milkweed Family	Orange	May-Sep	○-●	UPL	Attract butterflies; tolerates dry conditions
<i>Aster cordifolius</i>	Blue wood aster	Aster Family	Blue	Aug-Sep	►-●	UPL	Suited for woodlands; blooms late in summer
<i>Aster divaricatus</i>	White wood aster	Aster Family	White	Aug-Sep	►-●	UPL	Found in woodlands and forest edges
<i>Aster laevis</i>	Smooth blue aster	Aster Family	Violet blue	Aug-Sep	○-►	UPL	Forms vase-shaped clumps; striking in late summer
<i>Aster lateriflorus</i>	Calico aster	Aster Family	White-pink	Aug-Sep	○-►	UPL	'Lady in Black' has tall black foliage
<i>Aster novae-angliae</i>	New England Aster	Aster Family	Purple	Aug-Oct	○-►	FACW-	Showy and frequently cultivated
<i>Aster puniceus</i>	Purple stemmed aster	Aster Family	Blue	Aug-Sep	○-►	OBL	Does well in moist meadows; deep green foliage
<i>Baptisia australis</i>	Blue false indigo	Pea Family	Blue	Apr-May	○-►	UPL	Slow to establish but forms large clumps; beautiful garden plant
<i>Chelone glabra</i>	Turtlehead	Snap Dragon Family	White	Jul-Sep	○-►	OBL	* Tolerates wet; strong grower; herbal uses; attracts hummingbirds
<i>Cimicifuga racemosa</i>	Black cohosh	Buttercup Family	White	Jun-July	►-●	UPL	Wand-like white flowers; medicinal uses
<i>Claytonia virginica</i>	Spring beauty	Purslane Family	Pink	Mar-Apr	○-►	UPL	* Ideal in open woodland; often found in floodplains
<i>Dicentra cucullaria</i>	Dutchman's-breeches	Fumitory Family	White	Apr-May	►-●	UPL	Fern-like foliage; flowers look like inflated trousers; woodland plant
<i>Echinacea purpurea</i>	Coneflower	Aster Family	Purple	Jul-Sep	○	UPL	Colorful perennial; medicinal uses
<i>Eupatorium fistulosum</i>	Joe-pye weed	Aster Family	Purple	Aug-Sep	►	FACW	Attracts beneficial insects; herbal uses
<i>Eupatorium maculatum</i>	Spotted joe-pye	Aster Family	Red	Jul-Aug	○	FACW	'Gateway' has burgundy foliage; attracts butterflies
<i>Eupatorium perfoliatum</i>	Boneset	Aster Family	White	Jul-Aug	►-●	FACW	Colorful wet meadow species
<i>Eupatorium rugosum</i>	White snakeroot	Aster Family	White	Jul-Oct	○-●	UPL	Tough plant; can grow in dry shade
<i>Gentiana andrewsii</i>	Blue gentian	Gentian Family	Blue	Apr-Oct	○-►	FACW	Bottle-shaped flowers; moist meadow species



BOTANIC NAME	COMMON NAME	FAMILY NAME	FLOWER	BLOOM TIME	SUN LIGHT	MOISTURE	* MOISTURE	DISTINGUISHING CHARACTERISTICS
<i>Gentiana clausa</i>	Closed gentian	Gentian Family	Blue	Aug-Oct	►	FACW		Grows in wet meadows
<i>Geranium maculatum</i>	Wood geranium	Geranium Family	Blue rose- pink	Apr-May	○►	FACU		Spring loaded seed capsules catapult the seed away from the plant
<i>Helenium autumnale</i>	Autumn sneezeweed	Aster Family	Yellow	Aug-Oct	○●	FACW+		Showy daisy-like flowers; herbal uses
<i>Helianthus angustifolius</i>	Swamp sunflower	Aster Family	Yellow	Jul-Sep	○●	FACW		Showy flowers; good for birds
<i>Helipopsis helianthoides</i>	Ox-eye	Aster Family	Yellow	Jul-Sep	○●	UPL		Long bloom time; attracts butterflies
<i>Hepatica nobilis</i>	Liverleaf	Buttercup Family	Violet- blue	Mar-Apr	►●	UPL		Tiny flowers on wiry stems; liver shaped leaves; beautiful woodland plant
<i>Heuchera americana</i>	Alum root	Saxifrage Family	silver- bluish	Jul-Aug	○●	UPL		Semi-evergreen foliage; beautiful fall color
<i>Hibiscus moscheutos</i>	Rose mallow	Mallow Family	Pink, rose, white	Aug-Sep	○	OBL	*	Tolerates standing water, very showy flower
<i>Houstonia caerulea</i>	Bluets	Madder Family	Blue	Apr-May	○►	FACU		Blue flowers; will self seed
<i>Iris cristata</i>	Dwarf crested iris	Iris Family	Blue	Apr-May	○►	UPL		Spreads by rhizomes; short plant can be a groundcover
<i>Iris versicolor</i>	Blue flag iris	Iris Family	Blue	May-Jun	○►	OBL	*	Showy flowers
<i>Liatris spicata</i>	Blazing star	Aster Family	Violet	Jul-Sep	○	FAC+		Forms a dense clump over time
<i>Lobelia cardinalis</i>	Cardinal flower	Bell Flower Family	Scarlet	Jul-Sep	○●	FACW+		Long bloom time; attracts butterflies and hummingbirds
<i>Lobelia siphilitica</i>	Blue lobelia	Bell Flower Family	Blue	Jul-Oct	○►	FACW+		Long bloom time; attracts hummingbirds
<i>Mertensia virginica</i>	Virginia bluebells	Borage Family	Blue	Apr-May	○►	FACW		Strong clump forming plant
<i>Mimulus ringens</i>	Monkey flower	Snap Dragon Family	Violet	Jul-Sep	○►	OBL	*	Interesting flowers; colorful wet meadow species
<i>Mitchella repens</i>	Partridgeberry	Madder Family	White	Jun-Jul	►●	FACU		Evergreen; ground cover; edible berry ; tiny woodland treasure
<i>Monarda didyma</i>	Bee-balm	Mint Family	Red	Jul-Aug	○	FAC+		Showy flower; aromatic; attracts butterflies; herbal uses
<i>Pachysandra procumbens</i>	Allegheny pachysandra	Box Family	White	Apr-May	►●	UPL		Excellent woodland groundcover
<i>Penstemon digitalis</i>	Beard-tongue	Snapdragon Family	White	May-Jul	○	FAC		Attracts hummingbirds
<i>Penstemon hirsutus</i>	Hairy beard tongue	Snapdragon Family	Purple	Jun-Jul	○►	UPL		Purplish tubular flowers have a white lip
<i>Phlox divaricata</i>	Wild blue phlox	Phlox Family	Lilac	May-Jun	○●	FACU		Aromatic; attracts butterflies





BOTANIC NAME	COMMON NAME	FAMILY NAME	FLOWER	BLOOM TIME	SUN LIGHT	MOISTURE	* DISTINGUISHING CHARACTERISTICS
<i>Phlox paniculata</i>	Summer phlox	Phlox Family	Pink	Jul-Oct	O-●	FACU	Aromatic; showy flowers; attracts butterflies
<i>Phlox stolonifera</i>	Creeping phlox	Phlox Family	Blue	Apr-May	●	UPL	Groundcover phlox; lush leaves
<i>Physostegia virginiana</i>	Obedient plant	Mint Family	White	Jun-Jul	O-●	FAC+	Individual flowers can be moved and stay where placed
<i>Polemonium reptans</i>	Spreading Jacob's ladder	Phlox Family	Blue	Apr-Jul	O-●	FACU	Attractive flowers; slow spreader; herbal uses
<i>Polygonatum biflorum</i>	Solomon's seal	Lily Family	Yellow	Apr-Jun	O-●	UPL	Not fussy; blue berries; herbal and edible uses
<i>Pycnanthemum incanum</i>	Mountain mint	Mint Family	lavender	Jun-Jul	O-●	UPL	Fragrant foliage; silver bracts
<i>Rhexia virginica</i>	Meadow beauty	Melastome Family	Pink	Jun-Jul	O	OBL	Large pink flowers with long yellow stamens
<i>Rudbeckia hirta</i>	Black eyed susan	Aster Family	Orange	May-Sep	O-●	FACU-	Bright flowers; long bloom time
<i>Rudbeckia laciniata</i>	Green-eyed susan	Aster Family	Yellow	Jul-Sep	O-●	FACW	Tall daisy; herbal uses
<i>Rudbeckia triloba</i>	Thin leaved coneflower	Aster Family	Yellow-gold	Jul-Oct	O-●	FACU	Prolific self-seeder
<i>Sanguinaria canadensis</i>	Bloodroot	Poppy Family	White	Mar-May	●-●	UPL	Red sap; herbal uses; beautiful satiny foliage; woodland groundcover
<i>Saururus cernuus</i>	Lizard's tail	Lizard's Tail Family	White	May-Jul	O-●	OBL	* Attractive white flowers; riverine species
<i>Sedum ternatum</i>	Wild stonecrop	Stonecrop Family	White	Apr-May	O-●	UPL	Fleshy leaves; groundcover that tolerates shade
<i>Sisyrinchium angustifolium</i>	Blue-eyed grass	Iris Family	White	Jun-Jul	O-●	FACW	Tiny blue flowers above grassy foliage
<i>Solidago gigantea</i>	Smooth goldenrod	Aster Family	Yellow	Jul-Nov	O-●	FACW	Tall; purplish stem with smooth leaves
<i>Solidago rugosa</i>	Wrinkle-leaf goldenrod	Aster Family	Yellow	Jul-Nov	O-●	FAC	Tough plant; attracts butterflies
<i>Thalictrum pubescens</i>	Tall meadowrue	Buttercup Family	White	Jun-Jul	O-●	FACW+	Very tall plant with cloudy clusters of tiny flowers; bluish foliage
<i>Tiarella cordifolia</i>	Foamflower	Saxifrage Family	White	Apr-Jul	●-●	FAC-	Attractive; long blooming flower
<i>Verbena hastata</i>	Blue vervain	Vervain Family	Blue	Jun-Sep	O-●	UPL	Bright flowers; herbal uses
<i>Vernonia noveboracensis</i>	New York Ironweed	Aster Family	Purple	Jul-Sep	O	FACW+	Tall plant 4-6'; brilliant flowers
<b>SHRUBS</b>							
<i>Alnus serrulata</i>	Smooth alder	Birch Family	Purple	Mar-Apr	O	OBL	* Multi-stemmed; high wildlife value
<i>Aronia arbutifolia</i>	Red chokeberry	Rose Family	White	May	●	FACW	* Red berries; adaptable species
<i>Aronia melanocarpa</i>	Black chokeberry	Rose Family	White	Mar-Jul	●	FAC	Multi-stemmed; black berries; fall color
<i>Baccharis halimifolia</i>	Groundsel bush	Aster Family	White	Sep-Oct	O	FACW	* Waxy leaves, salt and brackish habitat
<i>Calycanthus floridus</i>	Carolina allspice	Strawberry shrub Family	Brown	Jun-Jul	O-●	UPL	Hardy shrub; unusual dark red flowers; sap has a sweet tropical scent
<i>Cephalanthus occidentalis</i>	Buttonbush	Madder Family	White	Jun-Sep	O	OBL	* Multi-stemmed; interesting fruit; tolerate inundation
<i>Clethra alnifolia</i>	Peppertbush	Clethra Family	White	Jul-Aug	●	FAC+	* Fragrant white flowers; very adaptable plant



BOTANIC NAME	COMMON NAME	FAMILY NAME	FLOWER	BLOOM TIME	SUN LIGHT	MOISTURE	* DISTINGUISHING CHARACTERISTICS
<i>Comptonia peregrina</i>	Sweetfern	Bayberry Family	Brown	Apr-May	○-▶	UPL	Edible leaves; tolerates dry acidic soil
<i>Cornus amomum</i>	Silky dogwood	Dogwood Family	White	May-Jul	○	FACW	* Flowers in summer; blue berries; multi-stemmed; very high wildlife value
<i>Cornus racemosa</i>	Swamp dogwood	Dogwood Family	white	May-Jun	▶	FAC	* Colonizer; high wildlife value
<i>Corylus americana</i>	Hazelnut	Birch Family	(m)brown n (f)red	Mar-Apr	▶	FACU	Strong multi-stem mature habit
<i>Gaylussacia baccata</i>	Black huckleberry	Heath Family	White	May	○-▶	FACU	Edible fruits; high wildlife value
<i>Gaylussacia frondosa</i>	Dangleberry	Heath Family	White	May	○-▶	FAC	Edible fruits; high wildlife value
<i>Hamamelis virginiana</i>	Witch-hazel	Witch-hazel Family	Yellow	Sep-Nov	○-●	FAC-	Bright yellow flowers; spider-like linear petals; medicinal uses
<i>Ilex verticillata</i>	Winterberry holly	Holly Family	White	May-June	▶	FACW+	* Showy berries in winter; high wildlife value
<i>Lindera benzoin</i>	Spice bush	Laural Family	Yellow	Mar-May	▶-●	FACW-	* Berries and foliage in fall; herbal uses; wildlife value
<i>Myrica pensylvanica</i>	Bayberry	Bayberry Family	Green	Mar-Apr	○	FAC	Semi-evergreen fragrant foliage
<i>Rhododendron viscosum</i>	Swamp azalea	Heath Family	White	Jun-Jul	○-▶	OBL	* Fragrant sticky flowers; fast grower
<i>Rosa palustris</i>	Swamp rose	Rose Family	Pink	Jun-Oct	○	OBL	* Tolerates inundation, very high wildlife value
<i>Rosa virginiana</i>	Wild rose	Rose Family	Pink	Jul-Sep	○-▶	FAC	Deep green glossy foliage; great fall color
<i>Salix discolor</i>	Pussy willow	Willow Family	Silvery	Feb-Mar	○-●	FACW	* Fast growing species; stabilizing plant
<i>Sambucus canadensis</i>	American elderberry	Honeysuckle Family	White	Jun-July	▶	FACW-	* Edible berries & flowers; multi-stemmed; very high wildlife value
<i>Vaccinium corymbosum</i>	Highbush blueberry	Heath Family	White	May-Jun	▶	FACW-	* Multi-stemmed; edible berries; fall color; very high wildlife value
<i>Vaccinium pallidum</i>	Low bush blueberry	Heath Family	White	Jul-Oct	○-▶	UPL	Low growing, spreading shrub; great fall color; blue berries
<i>Viburnum dentatum</i>	Southern arrowwood	Honeysuckle Family	White	May-Jun	▶	FAC	* Very adaptable; high wildlife value
<i>Viburnum lentago</i>	Nannyberry	Honeysuckle Family	White	May	▶	FAC	Straight upright growth; multi-stemmed clumps
<i>Viburnum prunifolium</i>	Blackhaw viburnum	Honeysuckle Family	White	May	●	FACU	Good fall color, large shrub/small tree
<b>TREES</b>							
<i>Amelanchier arborea</i>	Shadbush	Rose Family	White	Apr	▶	FAC	Early spring flowers; delicious berries in summer
<i>Amelanchier laevis</i>	Juneberry	Rose Family	White	Spring	▶	FACU	Black edible fruit, high wildlife value
<i>Betula nigra</i>	River birch	Birch Family	Yellow green	Apr-May	○-▶	FACW	* Catkins; exfoliating bark for winter interest; high wildlife value
<i>Carpinus caroliniana</i>	Blue-beech	Birch Family	Red	Apr-May	▶	FAC	Bark and form are beautiful in the winter landscape; small tree



BOTANIC NAME	COMMON NAME	FAMILY NAME	FLOWER	BLOOM TIME	SUN LIGHT	MOISTURE	* DISTINGUISHING CHARACTERISTICS
<i>Carya tomentosa</i>	Mockernut hickory	Walnut Family	Yellow	May	O	UPL	Picturesque branches; high wildlife value
<i>Cercis canadensis</i>	Eastern redbud	Caesalpinia Family	Purple	April	►	UPL	Beautiful flowers in spring; fixes nitrogen; forest edge species
<i>Chionanthus virginicus</i>	Fringe-tree	Olive Family	White	May-Jun	►	FAC+	Showy white fragrant flowers
<i>Cornus florida</i>	Flowering dogwood	Dogwood Family	White bracts	Apr-Jun	►	FACU-	White bracts in spring; red berries; very high wildlife value
<i>Diospyros virginiana</i>	Persimmon	Ebony Family	Yellow-orange	May-Jun	O	FAC-	High wildlife value
<i>Fraxinus pennsylvanica</i>	Green Ash	Olive Family	Purple	Apr-May	►	FACW	* Fast growth; fall color
<i>Juglans nigra</i>	Black walnut	Walnut Family	Yellow	May-Jun	O	FACU	* Fast growing species; high wildlife value
<i>Nyssa sylvatica</i>	Black gum	Black Gum Family	Greenish white	Apr-May	O-►	FAC	Outstanding fall color; high wildlife value
<i>Oxydendrum arboreum</i>	Sourwood	Heath Family	White	July	O-►	UPL	Glossy foliage; great fall color
<i>Platanus occidentalis</i>	Sycamore	Sycamore Family	Yellow green	May-Jun	O-►	FACW-	* Showy mottled bark; good riparian species
<i>Prunus serotina</i>	Wild black cherry	Rose Family	White	May-Jun	►	FACU	Desirable lumber species; high wildlife value
<i>Quercus bicolor</i>	Swampwhite oak	Beech Family	Yellow	May	►	FACW+	* Very high wildlife value; good wetland oak
<i>Quercus coccinea</i>	Scarlet oak	Beech Family	Red	May-Jun	O	UPL	Very high wildlife value; beautiful fall color
<i>Quercus palustris</i>	Pin oak	Beech Family	Yellow	Apr-May	O	FACW	* Common ornamental street tree; fall color; very high wildlife value
<i>Salix nigra</i>	Black willow	Willow Family	Yellow	Apr-May	O	FACW+	Catkins in spring; very fast grower
<i>Tilia americana</i>	Basswood	Basswood Family	Yellow	May-Jun	O-●	FACU	* Flowers aromatic; with herbal uses
<i>Ulmus americana</i>	American elm	Elm Family	Red	Mar-Apr	►-●	FACW-	High wildlife value; distinctive 'vase' shape
<b>VINE</b>							
<i>Parthenocissus quinquefolia</i>	Virginia creeper	Grape Family	Green	Jul-Oct	O-●	FACU	Twining habit; great fall color; grows easily



# COMMON NAME CROSS REFERENCE

<u>COMMON NAME</u>	<u>GENUS</u>	<u>SPECIES</u>	<u>COMMON NAME</u>	<u>GENUS</u>	<u>SPECIES</u>
<b><u>GRASSES</u></b>			<b><u>FERNS</u></b>		
Big bluestem	<i>Andropogon</i>	<i>gerardii</i>	Cinnamon fern	<i>Osmunda</i>	<i>cinnamomea</i>
Blue joint grass	<i>Calamagrostis</i>	<i>canadensis</i>	Goldie's wood fern	<i>Dryopteris</i>	<i>goldiana</i>
Broom sedge	<i>Andropogon</i>	<i>virginicus</i>	Interrupted fern	<i>Osmunda</i>	<i>claytoniana</i>
Indian grass	<i>Sorghastrum</i>	<i>nutans</i>	Ostrich fern	<i>Matteucia</i>	<i>struthiopteris</i>
Little bluestem	<i>Schizachyrium</i>	<i>scoparium</i>	Royal fern	<i>Osmunda</i>	<i>regalis</i>
Softstemmed bulrush	<i>Schoenoplectus</i>	<i>tabernaemontani</i>	Sensitive fern	<i>Onoclea</i>	<i>sensibilis</i>
Switch grass	<i>Panicum</i>	<i>virgatum</i>			
Tussock sedge	<i>Carex</i>	<i>stricta</i>			
Wild oats	<i>Chasmanthium</i>	<i>latifolium</i>			
Wool grass	<i>Scirpus</i>	<i>cyperinus</i>			
<b><u>HERBACEOUS PERENNIALS</u></b>			<b><u>HP (CONT.)</u></b>		
Allegheny pachysandra	<i>Pachysandra</i>	<i>procumbens</i>	Monkey flower	<i>Mimulus</i>	<i>ringens</i>
Alum root	<i>Heuchera</i>	<i>americana</i>	Mountain mint	<i>Pycnanthemum</i>	<i>incanum</i>
Aster-like boltonia	<i>Boltonia</i>	<i>asteroides</i>	New England Aster	<i>Aster</i>	<i>novae-angliae</i>
Autumn sneeze weed	<i>Helenium</i>	<i>atumnale</i>	New York Aster	<i>Vernonia</i>	<i>noveboracensis</i>
Beards-tongue	<i>Penstemon</i>	<i>digitalis</i>	Ox-eye	<i>Heliopsis</i>	<i>helianthoides</i>
Bee-balm	<i>Monarda</i>	<i>didyma</i>	Partridgeberry	<i>Mitchella</i>	<i>repens</i>
Black cohosh	<i>Cimicifuga</i>	<i>racimosa</i>	Prickly pear	<i>Opuntia</i>	<i>humifusa</i>
Black eyed susan	<i>Rudbeckia</i>	<i>hirta</i>	Purple semmed aster	<i>Aster</i>	<i>puniceus</i>
Blazing star	<i>Liatris</i>	<i>spicata</i>	Rose mallow	<i>Hibiscus</i>	<i>moscheutos</i>
Bleeding hearts	<i>Dicentra</i>	<i>eximia</i>	Shooting star	<i>Dodecatheon</i>	<i>meadia</i>
Bloodroot	<i>Sanguinaria</i>	<i>canadensis</i>	Smooth blue aster	<i>Aster</i>	<i>laevis</i>
Blue false indigo	<i>Baptisia</i>	<i>australis</i>	Smooth goldenrod	<i>Solidago</i>	<i>gigantea</i>
Blue flag iris	<i>Iris</i>	<i>versicolor</i>	Solomon's seal	<i>Polygonatum</i>	<i>biflorum</i>
Blue gentian	<i>Gentiana</i>	<i>andrewsii</i>	Spreading Jacob's ladder	<i>Polemonium</i>	<i>reptans</i>
Blue lobelia	<i>Lobelia</i>	<i>siphilitica</i>	Spring beauty	<i>Claytonia</i>	<i>virginica</i>
Blue vervain	<i>Verbena</i>	<i>hastata</i>	Summer phlox	<i>Phlox</i>	<i>paniculata</i>
Blue wood aster	<i>Aster</i>	<i>cordifolius</i>	Swamp milkweed	<i>Asclepias</i>	<i>incarnata</i>
Blue-eyed grass	<i>Sisyrinchium</i>	<i>angustifolium</i>	Swamp sunflower	<i>Helianthus</i>	<i>angustifolia</i>
Bluets	<i>Houstonia</i>	<i>caerulea</i>	Tall meadowrue	<i>Thalictrum</i>	<i>polygamumum</i>
Boneset	<i>Eupatorium</i>	<i>perfoliatum</i>	Thin leafed coneflower	<i>Rudbeckia</i>	<i>triloba</i>
Butterfly weed	<i>Asclepias</i>	<i>tuberosa</i>	Turtlehead	<i>Chelone</i>	<i>glabra</i>
Cardinal flower	<i>Lobelia</i>	<i>cardinalis</i>	Virginia bluebells	<i>Mertensia</i>	<i>virginica</i>
Closed gentian	<i>Gentiana</i>	<i>clausa</i>	White snakeroot	<i>Eupatorium</i>	<i>rugosum</i>
Columbine	<i>Aquilegia</i>	<i>canadensis</i>	White wood aster	<i>Aster</i>	<i>divaricatus</i>
Coneflower	<i>Echinacea</i>	<i>purpurea</i>	Wild blue phlox	<i>Phlox</i>	<i>divaricata</i>
Creeping phlox	<i>Phlox</i>	<i>stolonifera</i>	Wild stonecrop	<i>Sedum</i>	<i>ternatum</i>
Cutleaf coneflower	<i>Rudbeckia</i>	<i>laciniata</i>	Wood geranium	<i>Geranium</i>	<i>maculatum</i>
Dutchman's-breeches	<i>Dicentra</i>	<i>cucullaria</i>	Wrinkle-leaf goldenrod	<i>Soidago</i>	<i>rugosa</i>
Dwarf crested iris	<i>Iris</i>	<i>cristata</i>			
False dragonhead	<i>Physostegia</i>	<i>virginiana</i>			
Foamflower	<i>Tiarella</i>	<i>cordifolia</i>			
Ginger	<i>Asarum</i>	<i>canadense</i>			
Goatsbeard	<i>Aruncus</i>	<i>dioicus</i>			
Hairy beard tongue	<i>Penstemon</i>	<i>hirsutus</i>			
Jack-in-the-pulpit	<i>Arisaema</i>	<i>triphylum</i>			
Joe-pye weed	<i>Eupatorium</i>	<i>fistulosum</i>			



<u>COMMON NAME</u>	<u>GENUS</u>	<u>SPECIES</u>
Lady in Black	<i>Aster</i>	<i>lateriflorus</i>
Liverleaf	<i>Hepatica</i>	<i>nobilis</i>
Lizard's tail	<i>Saururus</i>	<i>cernua</i>
Meadow beauty	<i>Rhexia</i>	<i>virginica</i>

### SHRUBS

American elderberry	<i>Sambucus</i>	<i>canadensis</i>
Bayberry	<i>Myrica</i>	<i>pensylvanica</i>
Black chokeberry	<i>Aronia</i>	<i>melanocarpa</i>
Black huckleberry	<i>Gaylussacia</i>	<i>baccata</i>
Blackhaw viburnum	<i>Viburnum</i>	<i>prunifolium</i>
Buttonbush	<i>Cephalanthus</i>	<i>occidentalis</i>
Carolina allspice	<i>Calycanthus</i>	<i>floridus</i>
Dangleberry	<i>Gaylussacia</i>	<i>frondosua</i>
False indigo	<i>Amorpha</i>	<i>fruticosa</i>
Fetterbush	<i>Leucothoe</i>	<i>racemosa</i>
Groundsel bush	<i>Baccharis</i>	<i>halmifolia</i>
Hazelnut	<i>Corylus</i>	<i>americana</i>
Highbush blueberry	<i>Vaccinium</i>	<i>corymbosum</i>
Inkberry	<i>Ilex</i>	<i>glabra</i>
Low bush blueberry	<i>Vaccinium</i>	<i>pallidum</i>
Nannyberry	<i>Viburnum</i>	<i>lentago</i>
Pepperbush	<i>Clehra</i>	<i>alnifolia</i>
Pussy willow	<i>Salix</i>	<i>discolor</i>
Red chokeberry	<i>Aronia</i>	<i>arbutifolia</i>
Silky dogwood	<i>Cornus</i>	<i>amomum</i>
Smooth alder	<i>Alnus</i>	<i>serrulata</i>
Southern arrowwood	<i>Viburnum</i>	<i>dentatum</i>
Spice bush	<i>Lindera</i>	<i>benzoin</i>
Swamp azalea	<i>Rhododendron</i>	<i>viscosum</i>
Swamp dogwood	<i>Cornus</i>	<i>racemosa</i>
Swamp rose	<i>Rosa</i>	<i>palustris</i>
Sweetfern	<i>Comptonia</i>	<i>peregrina</i>
Virginia sweetspire	<i>Itea</i>	<i>virginica</i>
Wild rose	<i>Rosa</i>	<i>virginiana</i>
Winterberry holly	<i>Ilex</i>	<i>verticillata</i>

<u>COMMON NAME</u>	<u>GENUS</u>	<u>SPECIES</u>
--------------------	--------------	----------------

### TREES

American elm	<i>Ulmus</i>	<i>americana</i>
Bald cypress	<i>Taxodium</i>	<i>distichum</i>
Basswood	<i>Tilia</i>	<i>americana</i>
Black gum	<i>Nyssa</i>	<i>sylvatica</i>
Black walnut	<i>Juglans</i>	<i>nigra</i>
Black willow	<i>Salix</i>	<i>nigra</i>
Blue-beech	<i>Carpinus</i>	<i>caroliniana</i>
Eastern redbud	<i>Cercis</i>	<i>canadensis</i>
Flowering dogwood	<i>Cornus</i>	<i>florida</i>
Fringe-tree	<i>Chionanthus</i>	<i>virginicus</i>
Green Ash	<i>Fraxinus</i>	<i>pennsylvanica</i>
Juneberry	<i>Amelanchier</i>	<i>laevis</i>
Mockernut hickory	<i>Carya</i>	<i>tomentosa</i>
Persimmon	<i>Diospyros</i>	<i>virginiana</i>
Pin oak	<i>Quercus</i>	<i>palustris</i>
River birch	<i>Betula</i>	<i>nigra</i>
Scarlet oak	<i>Quercus</i>	<i>coccinea</i>
Shadbush	<i>Amelanchier</i>	<i>canadensis</i>
Sourwood	<i>Oxydendrum</i>	<i>arboreum</i>
Swampwhite oak	<i>Quercus</i>	<i>bicolor</i>
Sweetbay magnolia	<i>Magnolia</i>	<i>virginiana</i>
Sycamore	<i>Platanus</i>	<i>occidentalis</i>
Wild black cherry	<i>Prunus</i>	<i>serotina</i>
Willow oak	<i>Quercus</i>	<i>phellos</i>

### VINE

Virginia creeper	<i>Parthenocissus</i>	<i>quinquefolia</i>
------------------	-----------------------	---------------------



## APPENDIX B

### SAMPLE MUNICIPAL ORDINANCE

In this section you will find a sample ordinance which effectively embodies stormwater best management practices with an emphasis on protecting existing natural resources, encouraging stormwater infiltration, and protecting the natural hydrologic cycle.

Of course all municipal ordinances need to fulfill state and local regulatory requirements to be effective and defensible. But this ordinance can help serve as a guide and provide important language to secure effective stormwater management in your community.





**ROCKAWAY RIVER WATERSHED CABINET  
SUSTAINABLE WATERSHED MANAGEMENT PROGRAM**

**COMPREHENSIVE STORMWATER MANAGEMENT ORDINANCE**

Prepared by

Cahill Associates  
West Chester, PA

for

**THE ROCKAWAY RIVER WATERSHED CABINET**

**DRAFT  
JULY, 1999**



## **SECTION 102. STATUTORY AUTHORITY**

\_\_\_\_ Township is empowered to regulate land use activities that affect stormwater runoff by the authority of the New Jersey Municipal Land Use Law, as presently codified as 40:55D-1 of the New Jersey statutes. This Ordinance is a part of the Subdivision and Site Plan Ordinance of \_\_\_\_\_ Township. Stormwater management is also a part of the municipal Comprehensive Management Plan (NJSA 40:55D-28(b)(5)), and this Ordinance is consistent with the criteria required in that Plan.

## **SECTION 103. APPLICABILITY**

These regulations apply to:

- all activities governed by the \_\_\_\_ Township Subdivision and Site Plan Ordinance (SSPO)
- construction of separate or additional impervious or semi-pervious surfaces (driveways, parking lots, additions to buildings, etc.)
- other earthmoving activities
- outdoor storage
- any other land disturbances.

No land or waterway shall be used or modified, no earth shall be disturbed, stripped, or moved, and no structure or other impervious surface shall be built or extended without full compliance with the terms of this Ordinance and other applicable regulations.

## **SECTION 104. REPEALER**

An ordinance inconsistent with any of the provisions of this Ordinance is hereby repealed to the extent of the inconsistency only.

## **SECTION 105. SEVERABILITY**

Should any section or provision of this Ordinance be declared invalid by a court of competent jurisdiction, such decision shall not affect the validity of any remaining provisions of this Ordinance.

## **SECTION 106. COMPATIBILITY WITH OTHER ORDINANCE REQUIREMENTS**

Approvals issued/actions taken pursuant to this Ordinance do not relieve the Applicant of the responsibility to secure required permits or approvals for activities regulated by any other applicable code, rule, act, or ordinance. To the extent that this Ordinance is more rigorous in terms of the standards applied for stormwater management, the specific stormwater management standards and design criteria contained in this Ordinance are to be followed.

## ARTICLE II DEFINITIONS

(see Section \_\_\_\_)

## ARTICLE III COMPREHENSIVE STORMWATER MANAGEMENT STANDARDS

### SECTION 301. STANDARDS FOR PERMANENT STORMWATER MANAGEMENT

All land disturbances as listed in Table 1 shall comply with provisions of this Section.

---

TABLE 1

Land Disturbances Required to Comply with Section 301

---

1. All minor and major subdivisions and land developments where land disturbance exceeds 5,000 sq ft.

---

2. An impervious cover addition to an existing developed property which exceeds 5 percent of lot area or 500 square feet, whichever is smaller.

---

3. A semi-impervious cover addition (gravel, lattice blocks) to an existing developed property which exceeds 800 square feet on slopes greater than 8 percent.

---

4. A temporary storage of impervious or pervious material (rock, soil, etc.) on an existing developed property where ground contact coverage exceeds 5 percent of lot area or 4,000 square feet (whichever is less), where the material is placed either on slopes exceeding 8 percent or on alluvial soils or a drainage way.

---

A. Permanent Stormwater Management Standards

1. Standard 1: After installation of impervious cover, there shall be no increase in the **volume** of stormwater runoff being discharged for up to the 2-year frequency rainfall, pre-development to post-development, based on the USDA-NRCS curve number and unit hydrograph technique or some other acceptable stormwater calculation method. If the Township Engineer determines that such a standard is not achievable on the site (all or in part), based on the existing soil, bedrock, water table, or other conditions on the parcel, Standard 3 provisions apply. For preliminary design purposes, this volume can be initially estimated as a depth of 2.5 inches per unit area of new impervious surface.
  
2. Standard 2: After installation of impervious cover and assuming full compliance with Standard 1, the peak rate of stormwater discharges from the site for all design storms up to and including a 100-year frequency rainfall shall not exceed the peak discharges from the site of the same storms before disturbance; design storms include:
  - 2-year, 24-hour storm;
  - 5-year, 24-hour storm;
  - 10-year, 24-hour storm;
  - 25-year, 24-hour storm;
  - 50-year, 24-hour storm;
  - 100-year, 24-hour storm.
  
3. Standard 3: If the volume standard set forth in Standard 1 cannot be achieved, then the peak rate standards are modified so that post-development peak rate discharges from the site for all storms up to the 10-year storm must be equal to or less than 75 percent of the respective peak rates for these storms, pre-development.
  
4. Standard 4: Under certain conditions, the Township, upon recommendation by the Township Engineer, may impose the following additional restrictions on stormwater discharges:
  - (a) Peak discharge may be further restricted when it can be shown that a probable risk to downstream structures or unique natural areas exists, or that existing severe flooding problems could be further aggravated.
  
  - (b) Measures shall be imposed to protect against ground or surface **water pollution** where the type of business activity may result in significant nonpoint source pollution (so called "hot spots"). If the nature of the soils or bedrock aquifer underlying a stormwater management structure constitutes substantial risk of contamination, such as might be the case in limestone formations or valley fills. Special provisions to be followed in these cases will be provided by the Township Engineer.

(c) Where groundwater yields are very low or where a groundwater supply already is heavily used, the Township may require that the entire volume of the 2-year frequency rainfall (3.2 inches in 24 hours) be retained and infiltrated.

5. Standard 5: Significant loadings of nonpoint source pollutants shall not be discharged into either surface or groundwater. Significant is defined as resulting in an increase greater than 10 percent of existing background concentrations of all water quality parameters of consequence identified in Federal and State criteria for this watershed. In particular, nutrients (nitrate and total phosphorus), metals (cadmium and lead), total petroleum hydrocarbons (TPH), and synthetic organic compounds identified by the US Environmental Protection Agency (USEPA) as toxic or hazardous substances must be controlled. If the volume and peak rate standards above (Standards 1 and 2) are met, then water quality impacts are assumed to be adequately controlled. If the volume standard (Standard 1) above cannot be achieved, then a water quality impact analysis must be performed, at the direction of the Township Engineer, confirming prevention of any significant increase in nonpoint source pollution, with particular focus on the pollutants discussed above. Both structural and nonstructural (preventive) measures are to be considered for reduction and prevention of nonpoint source pollution.

#### B. Stormwater Management Calculation Methods

1. In establishing the antecedent conditions for calculating runoff prior to land disturbance, the following assumptions shall apply:

(a) Average antecedent moisture conditions:

(b) A type II distribution storm;

(c) Woodland shall be used as the prior condition for those portions of the site having trees of greater than 6 inches caliper DBH or where such trees existed within 3 years of application;

(d) Meadow shall be used for all other areas including areas of existing cultivation or impervious surface.

(e) In performing the stormwater calculations, all those areas to be disturbed during construction will be assumed to be reduced one Hydrologic Soil Group category level during post-development runoff calculations (i.e., HSG B is reduced to HSG C, and so forth).

2. In all plans and designs for stormwater management system and

facilities submitted to the Township Engineer for approval, stormwater peak discharge rate and runoff volume shall be determined through the use of the Soil Cover Complex Method as set forth in Urban Hydrology for Small Watersheds, Technical Release No. 55. Specific attention shall be given to antecedent moisture conditions, flood routing, and peak discharge specifications included therein and in Hydrology National Engineering Handbook, Section 4, both by US Department of Agriculture, Natural Resources Conservation Service (Soil Conservation Service). Note that use of TR-55 (or TR-20) with many of the natural system-based approaches and practices recommended by this Ordinance requires that calculations be performed on a detailed small sub-area basis. The Township Engineer may permit the use of the Rational Method for calculation of runoff on land developments of 5 acres or less and for the design of storm structure controls (inlets, etc.).

3. In the calculation of runoff after development, those areas covered by concrete lattice blocks on an appropriate base, porous pavement areas on an appropriate base with groundwater recharge, and roof areas which drain to properly designed and installed storage/groundwater infiltration beds, shall be considered adequate to infiltrate any increased runoff from a 2-year storm.

C. Specific Stormwater Management System Design Criteria

1. Infiltration devices shall be selected based on suitability of soils and site conditions. Measures may include porous pavement with underground infiltration beds, vegetated infiltration beds, swales and trenches, or other seepage structures as proposed in the New Jersey Handbook of Best Management Practices and related references prepared by the USEPA, the Washington Metropolitan Council of Governments, the Soil Conservation Service, or other guidance documents.

2. Soil infiltration tests shall be performed for all proposed infiltration areas; these tests shall include evaluation of selected soil horizons by deep pits and percolation measurements. Testing should be reviewed and approved by the Township Engineer. The soil infiltration rate of discharge from the infiltration area being used in the proposed design shall be based on these measurements.

3. The lowest elevation of the infiltration bed area shall be at least two (2) feet above the Seasonal High Water Table (SHWT) and bedrock, except in the case of limestone formations or valley fills, in which case the distance shall be three (3) feet.

4. All roof drains shall discharge to infiltration systems, with appropriate measures such as leaf traps and cleanouts taken to prevent clogging by vegetation.

5. All infiltration systems shall have appropriate positive overflow controls to prevent storage within one (1) foot of the finished surface or grade.

6. All infiltration systems shall have a setback of fifteen (15) from all residential structures. Care should be taken to prevent any seepage into sub-grade structures.

7. All infiltration systems shall be designed to infiltrate the stored volume within twenty-four (24) hours.

8. All surface inflows shall be treated to prevent the direct discharge of sediment into the infiltration system; accumulated sediment reduces stormwater storage capacity and ultimately clogs the infiltration mechanism. No sand or other particulate matter may be applied to a pervious surface for winter ice conditions.

## SECTION 302. STANDARDS DURING LAND DISTURBANCE

A. During the period of land disturbance, when significant sediment can be contained in runoff, this runoff shall be controlled prior to entering any proposed infiltration area.

B. Peak discharges and discharge volumes from the site shall comply with the appropriate sections above, with the following additions:

1. For purposes of calculating required detention storage during land disturbance, peak discharges and discharge volumes shall be calculated based upon the runoff coefficients for bare soils during the maximum period and extent of disturbance. Controls shall insure that the difference in volumes and rates of peak discharge before disturbance and during shall not exceed those peak discharges and discharge volumes noted in Section 301 above. It should be understood that detention storage during the period of land disturbance and prior to establishment of permanent cover may require additional facilities on a temporary basis. Such measures shall be located so as to preserve the natural soil infiltration capacities of the planned infiltration bed areas.

2. Wherever soils, topography, cut and fill or grading requirements, or other conditions suggest substantial erosion potential during land disturbance, the Township, as recommended by the Township Engineer, may require that the entire volume of all storms up to a 2-year storm from the disturbed areas be retained on site and that special sediment trapping facilities (such as check dams, etc.) be installed.

C. Sediment in runoff water shall be trapped in accordance with criteria of the County Conservation District and NJDEP and removed through means approved by the Township Engineer to assure proper functioning and adequate capacity in the

basins or traps.

- D. Procedures shall be established for protecting soils or geologic structures with water supply potential from contamination by surface water or other disruption by construction activity.

### SECTION 303. SPECIAL STORMWATER MANAGEMENT DISTRICTS

#### A. The Riparian Buffer Area (RBA).

##### 1. Permitted Uses in the Riparian Buffer Area.

This area may be included in net density calculations with uses permitted in the Township Zoning Ordinance.

##### 2. Uniform Standards for the Riparian Buffer Area

- a. A 25-foot setback zone (Zone 1) of no disturbance except for restoration shall be maintained along perennial streams and bodies of water, starting measured from the top of the bank of the waterbody.
- b. A 50-foot managed buffer zone (Zone 2) shall be maintained outside of Zone 1.
- c. Waters designated shall be subject to the provisions of the NJDEP and its amendments.
- d. A zone of various width of level spreading devices (Zone 3) should be maintained adjacent to the above mentioned zone when no other runoff pollution control devices are being used on a site.

#### B. Hydrologic Management Areas (HMAs).

HMAs are (1) water-related land areas consisting of (a) wetlands including a twenty-five foot (25') buffer area along their boundary, (b) floodplain areas, (c) open spaces in lowland areas that are contiguous to riparian zones and (d) sites occupied by Best Management Practices, as well as (2) access easements along storm sewers, floodplains, and watercourses. These areas are to be designated as open space secured by deed restriction.

### SECTION 304. SELECTION OF STORMWATER BEST MANAGEMENT APPROACHES AND PRACTICES

Optimal stormwater management which comprehensively achieves quantity and quality standards at least cost will vary from site to site and with different uses. Although stormwater plans themselves will be different, **the process or procedure for figuring out what to use where and under what conditions does have a structure.** This



Comprehensive Stormwater Management Procedure has been defined; a guidance document (Appendix A The Comprehensive Stormwater Management Procedure) is available at \_\_\_ Township and through the Township Engineer. A Procedure Application Report must be submitted as part of the Comprehensive Stormwater Management Plan in order to demonstrate that the Procedure has been properly applied. Additional technical references and guidance documents also are available at \_\_\_ Township and through the Township Engineer.

Note that the selection of a competent and creative design engineer by the applicant clearly is critical. In order to achieve the standards and construction and maintenance cost reductions which are intended in this regulation, additional time and money is required in the process in preliminary engineering and design. Review and approval of a Comprehensive Stormwater Management Plan will be heavily dependent on the technical review by the Township Engineer and compliance with this Ordinance.

## ARTICLE IV COMPREHENSIVE STORMWATER MANAGEMENT PROCEDURES

### SECTION 401. COMPREHENSIVE STORMWATER MANAGEMENT PLAN REQUIREMENT

As part of all applications for preliminary subdivision or land development plans and building permits, except those exempted by Article III, a Comprehensive Stormwater Management Plan is required and must be reviewed and approved by the \_\_\_\_\_ Township Engineer. This Comprehensive Stormwater Management Plan shall include the documentation called for in Section 402 and 403 of this Ordinance. This Plan shall be submitted to the Morris County Conservation District for its review and approval.

### SECTION 402. COMPREHENSIVE STORMWATER MANAGEMENT PLAN RELATED TO SUBDIVISION OR LAND DEVELOPMENT

- A. The Comprehensive Stormwater Management Plan shall demonstrate that all land disturbance activities related to the subdivision or land development comply with the performance standards set forth in Article III of this Ordinance.
- B. The Comprehensive Stormwater Management Plan shall contain all of the information required by Section 404 below. The applicant and/or his engineer shall confer with the Township Engineer prior to the preparation of a Comprehensive Stormwater Management Plan.
- C. The Comprehensive Stormwater Management Plan shall be reviewed by the Township Engineer, who shall submit a report thereon to the Township Planning Board within 30 days of submission of the Plan.
- D. if, in the Township Engineer's view, the Comprehensive Stormwater Management Plan as submitted satisfies all requirements of this Ordinance, he shall recommend its approval to the Planning Board. That recommendation shall be considered by the Planning Board, together with the results of their own reviews and the comments of any other reviewing body.
- E. If the Township Engineer determines that the Comprehensive Stormwater Management Plan fails to satisfy all requirements of this Ordinance, he shall so indicate in his report to the Planning Board and shall specify those items not in compliance with the Ordinance. The Township shall communicate these items to the applicant and, should the applicant want to remedy the deficiencies, the Township shall confer with the applicant to mutually agree whether a resubmission would initiate a new 90-day review period, extend the existing review period, or occur within the existing review period. The applicant and Township shall agree in writing to the terms and conditions of any such resubmission schedule.
- F. The Township may approve the Comprehensive Stormwater Management Plan with conditions to be addressed as part of the final subdivision or land development application. Such conditions will be agreed to by the applicant, in writing, prior to conditional approval. If these conditions are not accepted by the

applicant, the Township may deny approval of the subdivision or land development application.

- G. As part of any final subdivision or land development plan, the applicant shall submit:
  - 1. All construction specifications for stormwater management facilities as outlined in this Ordinance and as further specified by the Township Engineer;
  - 2. Proof of liability insurance over the term of the project, if required under Section 404(J);
  - 3. A performance guarantee as outlined in Article VI;
  - 4. Detailed documents necessary to comply with the maintenance requirements of Article V;
  - 5. Such other information as is deemed necessary by the Township Engineer.
- H. The applicant may request in writing the approval of the final subdivision or land development plan conditioned upon satisfactory submission of the above. No site work shall begin until all conditions are met.
- I. Where the final Comprehensive Stormwater Management Plan submission does not comply with the performance standards set forth in Article III of this Ordinance, or other application requirements of this Ordinance, such failure to comply may be considered grounds for denial of the final subdivision or land development application.

**SECTION 403. COMPREHENSIVE STORMWATER MANAGEMENT PLAN RELATED TO BUILDING CONSTRUCTION**

- A. Where individual on-lot land disturbance activities have been addressed, approved, and noted as such in an applicant's Comprehensive Stormwater Management Plan related to a subdivision or land development, applications for building permits for each individual lot shall reference such approval. In these cases, it shall not be necessary for the applicant to resubmit a Comprehensive Stormwater Management Plan concurrent with applications for building permits, provided the proposed grading of the lot and the locations of houses, driveways, and stormwater management facilities of any type are not changed.
- B. In all other cases, or in cases where an applicant in A, above, wishes to alter grading, building locations, or the on-lot stormwater management system, the applicant shall submit a Comprehensive Stormwater Management Plan. This Plan shall accompany the application for a building permit and shall demonstrate that all land disturbance activities related to the building construction shall comply with the performance standards in Article III and any

other applicable provisions of this Ordinance.

- C. The Township may require that the Comprehensive Stormwater Management Plan contain all of the information mandated by Section 404. The applicant and/or his engineer shall confer with the Township Engineer prior to the preparation of a Comprehensive Stormwater Management Plan to determine the scope and detail of the submission.
- D. The applicant's Comprehensive Stormwater Management Plan shall be reviewed by the Township Engineer, who shall submit a report thereon to the applicant and the Zoning Officer (Zoning or Building Inspector or Codes Enforcement Officer) and a copy to the Planning Board, within 30 days of submission of the Plan.
- E. Where revisions to the Plan are necessary in order to meet the performance standards set forth in Article III, the applicant shall discuss the contents of the report with the Township Engineer. All necessary revisions shall be effected and submitted to the Township Engineer.
- F. Within 10 days after receipt of the applicant's revisions, the Township Engineer shall review the revisions and issue a supplementary report to the applicant and the Zoning Officer, with a copy to the Planning Board, recommending approval or disapproval of the Plan.
- G. If the final Comprehensive Stormwater Management Plan is not in compliance with the performance standards set forth in Article III, failure to so comply may be considered grounds for denial of the building permit.
- H. Approval of a building permit shall constitute approval of the accompanying Comprehensive Stormwater Management Plan; these approvals may be concurrent.

#### SECTION 404. STORMWATER MANAGEMENT PLAN CONTENT

Except as may be modified for activities in Section 403, the Comprehensive Stormwater Management Plan required by Section 401 of \_\_\_\_\_ Township Subdivision and Site Plan Ordinance, shall consist of two parts: (a) a map or maps describing the topography of the area, the proposed alteration to the area, the proposed erosion and sedimentation control measures and facilities, and the proposed permanent stormwater control measures and facilities; and (b) a narrative report describing the project and its compliance with applicable sections of Article III, giving the purpose and the engineering assumptions and calculations for control measures and facilities. The following elements shall be included in the map and narrative portions of the Plan (except where already prepared as part of the preliminary subdivision or land development plan required by the SSPO).

- A. A narrative summary of the project, including:
  - general description of the project;

- general description of accelerated erosion control;
- general description of sedimentation control;
- general description of stormwater management, both during and after construction;
- date project is to begin and expected date final stabilization will be completed.

B. Mapping of various physical features of the project area at a scale of 1" = 50', both existing and proposed, including:

- the location of the project relative to highways, municipal boundaries, and other identifiable landmarks;
- property lines of proposed project area;
- contour lines at vertical intervals of not more than 2 feet for land with average natural slope of 4 percent or less, and at intervals of not more than 5 feet for land with average natural slope exceeding 4 percent (including location and elevation to which contour lines refer);
- acreage or square footage of the project;
- wetlands (both state and federal jurisdiction), streams, lakes, ponds, or other bodies of water within the subject property or within 50 feet of any boundary of the property; intermittent streams and natural drainageways also should be shown;
- other significant natural features, including existing drainage swales, tree masses, and areas of trees and shrubs to be protected during construction;
- proposed location of underground utilities, sewer and/or water lines;
- scale of map and north arrow;
- existing roads and easement.

C. Mapping of the soils and underlying geology of the project area, including:

- soil types, including depth, slope, texture, and structure
- Hydrologic Soil Group classifications and soil rated permeabilities in inches per hour
- Soil constraints including depth to bedrock, depth to Seasonal High Water Table
- geologic formations underlying the project area and extending 50 feet beyond all property boundaries;
- describe aquifer characteristics of formations; highlight special formations such as limestone or valley fill aquifers.

D. A map of proposed alterations to the project area, including:

- changes to land surface and vegetative cover, including zones of disturbance, zones of non-disturbance
- areas of cuts;
- areas of fill;
- structures, roads, paved areas, and buildings;

- proposed stormwater control provisions, both nonstructural and structural facilities;
  - finished contours at intervals as described in Section \_\_\_\_;
- E. Calculations and description of the amount of runoff from the project area and the upstream watershed area, in accordance with the terms of Section 301 of this Ordinance, including:
- method of calculation and figures used (including square footages for impervious surfaces of buildings, driveways, parking areas, etc.);
  - factors considered.
- F. The time schedule for land disturbance activities including:
- cover removal, including all cuts and fills;
  - installation of erosion and sediment control facilities and practices;
  - installation of improvements, including streets, storm sewers, underground utilities, sewer and water lines, buildings, driveways, parking areas, recreational facilities, and other structures;
  - program of operations to convert erosion and sedimentation controls to permanent stormwater management facilities, including a chart of the relative time sequence of activities.
- G. Temporary control measures and facilities for use during land disturbance, in both map and narrative form including:
- purpose;
  - temporary facilities or other soil stabilization measures to protect existing trees and shrubs from land disturbance activities;
  - types, locations, and dimensioned details of erosion and sedimentation control measures and facilities;
  - design considerations and calculations of control measures and facilities;
  - facilities to prevent tracking of mud by construction vehicles onto existing roadways.
- H. The Comprehensive Stormwater Management Procedure Report (the specific elements of this Report are defined in Appendix A and include responses to questions set out in the Procedure; additional guidance regarding application of the Procedure is available from the Township Engineer).
- I. Permanent stormwater management program (indicating, as appropriate, measures for groundwater recharge) and facilities for site restoration and long-term protection, in both map and narrative form, including:
- Purpose and relationship to the objectives of this Ordinance;
  - establishment of permanent vegetation or other soil stabilization measures;
  - installation of infiltration facilities, roof-top storage, cisterns, seepage pits, french drains, etc., to serve individual buildings;

- use of semi-pervious materials for driveways, parking areas, etc.;
- types, locations, and dimensioned details of facilities for stormwater detention and conveyance and for groundwater recharge;
- design considerations and calculations supporting the stormwater management program;
- location of drainage easements.

J. A narrative description of the maintenance procedures for both temporary and permanent control facilities, and of ownership arrangements, including:

- the methods and frequency of removing and disposing of sedimentation and other materials collected in control facilities, both during and upon completion of the project;
- the methods and frequency of maintaining all other control facilities, as necessary
- the proposed ownership and financial responsibility for maintenance of the permanent control facilities, including drainage and other easements, deed restrictions, and other legally binding provisions.

This description will result in a Maintenance Plan, to be jointly co-signed by the applicant and Township Engineer (see Article V below).

K. At the determination of the Township Engineer, proof of liability insurance and other ameliorative measures as deemed necessary.

## ARTICLE V MAINTENANCE AND INSPECTION OF PERMANENT STORMWATER MANAGEMENT FACILITIES

### SECTION 501. MAINTENANCE RESPONSIBILITIES

#### A. General Responsibilities

The owner of stormwater management facilities shall be responsible for their proper maintenance during and after development. A Maintenance Plan shall be prepared for review and approval by the Township Engineer and shall be executed and signed by the Township Engineer and applicant. Where appropriate, as described below, this Maintenance Plan also must be signed by the Homeowners Association. Where appropriate, maintenance responsibilities must be included as deed restrictions on individual lots. During all subsequent real estate transactions, maintenance responsibilities shall be pointed out to new owners. All deeds shall incorporate these specified maintenance responsibilities, making explicit individual owners responsibilities for stormwater management measures and for the common property.

On or before completion of subdivision or land development improvements, the permanent stormwater management system for a tract shall be fully installed and functional in accordance with the approved Comprehensive Stormwater Management Plan. Temporary sediment trapping facilities in detention basins, upon inspection and approval by the Township Engineer shall be converted into permanent stormwater management basins; additional facilities designed to serve more than an individual lot shall begin operation. All such work shall be as specified in the approved Plan.

#### B. Homeowners Association Ownership (Other than On-Lot Stormwater Facilities)

A single entity taking the form of a private corporation, partnership firm, estate or other legal entity empowered to own real estate exclusive of individual lot owners (i.e., Homeowners Association) shall be set up to manage stormwater management facilities that are suitable for such management, and perform other functions defined in this Ordinance. Responsibilities for ownership and management of facilities shall be defined in the Comprehensive Stormwater Management Plan.

#### C. Individual Lot Stormwater Facilities

1. Stormwater management facilities and systems that are located on an individual lot are the responsibility of that landowner to maintain. As with non-individual lot situations, a Comprehensive Stormwater Management Plan must be prepared, including a Maintenance Plan that shall include:
  - a. Any obligations concerning perpetuation of natural drainage or infiltration facilities, and/or the maintenance of facilities constructed by the individual lot owner under terms of his building permit (e.g., berms, cisterns, downspout connections, seepage pits, etc.)



- b. Assurances that no action will be taken by the occupant to disrupt or in any way impair the effectiveness of any stormwater management system.
- c. A description of the facilities and systems on the lot, as called for above, setting forth in deed restrictions binding on the landowner's successors in interest.

D. **Municipal Ownership**

Where the Township has accepted an offer of dedication of the permanent stormwater management facilities, the Township shall be responsible for maintenance. Municipal ownership notwithstanding, the applicant is required to prepare a Comprehensive Stormwater Management Plan including a Maintenance Plan component, as defined above. Upon approval of the stormwater management facilities by the Township, the applicant shall provide a financial security, in a form approved by the Township Solicitor for maintenance guarantees, as follows:

1. Long-term Maintenance Bond - The long-term maintenance bond shall be in any amount equal to the present worth of maintenance of the facilities for a ten year period. The estimated annual maintenance cost for the facilities shall be based on a reasonable fee schedule provided by the Township Engineer and adopted by the Planning Board.
2. Documentation - The terms of the maintenance guarantees shall be documented as part of the Comprehensive Stormwater Management Plan and the Maintenance Plan subpart.

- E. Failure of any person, individual lot owner or private entity to properly maintain any stormwater management facility shall be construed to be a violation of this Ordinance and is declared to be a public nuisance.

**SECTION 502. NEED FOR CORRECTIVE MEASURES.**

If the Township determines at any time that stipulated permanent stormwater management facilities have been eliminated, altered, or improperly maintained, the owner shall be advised of corrective measures required within a period of time set by the Township Engineer. If such measures are not taken by the owner, the Township may cause the work to be done and lien all costs against the property.

**SECTION 503. INSPECTIONS OF LAND DISTURBANCES RELATED TO SUBDIVISION OR LAND DEVELOPMENT**

All land disturbance work shall be performed in accordance with an inspection and construction control schedule approved by the Township Engineer as part of the Comprehensive Stormwater Management Plan. The Township Engineer should be

consulted for guidance regarding the timing and other details of necessary inspections.

No work shall proceed to a subsequent phase, including the issuance of the Certificate of Occupancy, until inspected and approved by the Township Engineer or his designee, who shall then file a report thereon with the Township.

**SECTION 504. LAND DISTURBANCES NOT RELATED TO SUBDIVISION OR LAND DEVELOPMENT.**

The timing and frequency of inspections of land disturbance activities not related to the subdivision/land development process shall be determined by the Township Engineer prior to final approval of the Comprehensive Stormwater Management Plan. Adherence to that schedule shall be a condition of Plan approval.

**SECTION 505. FEES ASSOCIATED WITH INSPECTIONS.**

Inspection fees for activities associated with Sections 503 and 504 shall be paid according to the provisions of the \_\_ Township Subdivision and Site Plan Ordinance.

## ARTICLE VI. FEES AND PERFORMANCE GUARANTEES

### SECTION 601. COMPREHENSIVE STORMWATER MANAGEMENT PLAN APPROVAL FEES.

#### A. Land Disturbance Related to Subdivision and Site Plan.

All fees and escrow deposits incident to approval of a Comprehensive Stormwater Management Plan and conduct of the work approved thereunder, where the land disturbance activities are to be undertaken as part of a subdivision or site plan, shall be established and submitted in accordance with Section \_\_ of the Township SSPO.

#### B. Other Land Disturbance Activities.

1. All parties submitting a Comprehensive Stormwater Management Plan for land disturbances not related to Subdivision and Site Plan Ordinance shall agree, in writing, to reimburse the Township for all costs of administration and review of the Plan by the Township staff, Engineer, and Solicitor. Funds shall be deposited with the Township Secretary in an amount as specified by resolution of the Governing Body.
2. Excluding fixed administrative costs, the applicant shall be charged only for time actually expended and detailed in bills from the Township Engineer and Solicitor. Any unexpended balance of the deposit shall be returned to the applicant following approval of the Plan.
3. If actual time required of either the Township Engineer or Solicitor will exceed the deposited amount, the Township shall render to the applicant a preliminary statement of time expended and shall require an additional deposit to complete reviews. Such required additional amounts must be deposited with the Township Secretary prior to approval of the Plan.

### SECTION 602. PERFORMANCE GUARANTEES.

Where proposed land disturbance activities are related to a subdivision or land development, the applicant shall be subject to the requirements for a performance guarantee that are specified in Section \_\_\_ of the Township SSPO. As stipulated in Section 501(D), a long-term maintenance bond and other requirements are imposed if stormwater management facilities are being conveyed to the municipality.

## ARTICLE VII VIOLATIONS AND PENALTIES

### SECTION 701. NOTIFICATION OF NON-COMPLIANCE WITH COMPREHENSIVE STORMWATER MANAGEMENT PLAN.

Any activity conducted pursuant to a Comprehensive Stormwater Management Plan approved by \_\_\_\_\_ Township shall be performed in strict compliance with the provisions of the Plan. Violations shall be treated in the following manner:

- A. Any non-compliance with the provisions of the Plan that is identified by the Township Engineer or his designee in the course of inspections as specified in this Ordinance shall be remedied by the applicant/owner according to the terms in this Ordinance.
- B. If at any time, work does not conform to the Plan, including all conditions and specifications and modifications thereof, a written notice to comply shall be given to the applicant/owner. Such notice shall set forth the nature of corrections required and the time within which corrections shall be made. Upon failure to comply within the time specified, the applicant/owner shall be considered in violation of this Ordinance, and the Township shall issue a cease and desist order on all work on the site, including any building or other construction, until corrections are made. If corrections are not undertaken within a specified time or the applicant/owner violates the cease and desist order: (1) penalties shall be imposed and/or (2) the work shall be completed by the Township and the costs charged to the applicant/owner.

### SECTION 702. PENALTIES.

Anyone violating the terms of this Ordinance shall be guilty of a summary offense and, upon conviction, shall be subject to a fine or penalty of not more than \$300 for each and every violation. Each day that the violation continues after proper notification shall be a separate offense. In addition thereto, the Township may institute injunctive, mandamus, or any other appropriate action or proceeding at law or equity for the enforcement of this Ordinance or to correct violations of this Ordinance, and any court of competent jurisdiction, shall have the right to issue restraining orders, temporary or permanent injunctions, or mandamus or other appropriate forms of remedy or relief.



## Appendix C

### Stormwater Credits: A Means of Supporting BMP Implementation





## **Stormwater Credits: A Means of Supporting BMP Implementation**

In Maryland, Stormwater Credits are a State program that groups non-structural stormwater practices into six groups that then carry a calculated credit towards meeting development standards on a site. This incentive program has been instituted as a way to encourage the implementation of non-structural best management practices with a goal of reducing nonpoint source pollution to the State's waterways.

The stormwater sizing criteria on which the credit program is based provide the developer with an incentive to reduce impervious cover at development sites, reducing the size of needed stormwater systems and lowering construction costs. Following is Chapter Five entitled "Stormwater Credits for Innovative Site Planning" from the 2000 Maryland Stormwater Design Manual Volume I, included in its entirety as an illustration of a strong BMP incentive program.







Chapter

**5.0**

Stormwater Credits for Innovative Site Planning

## 5.0 Stormwater Credits

In Maryland, there are many programs at both the State and local level that seek to minimize the impact of land development. Critical Areas, forest conservation, and local stream buffer requirements are designed to reduce nonpoint source pollution. Non-structural practices can play a significant role in reducing water quality impacts and are increasingly recognized as a critical feature of every stormwater BMP plan, particularly with respect to site design. In most cases, non-structural practices must be combined with structural practices to meet stormwater requirements. The key benefit of non-structural practices is that they can reduce the generation of stormwater from the site; thereby reducing the size and cost of stormwater storage. In addition, they can provide partial removal of many pollutants. Non-structural practices have been classified into six broad groups and are designed to mesh with existing state and local programs (e.g., forest conservation, stream buffers etc.). To promote greater use, a series of six stormwater credits are provided for designers that use these site planning techniques.

Credit 1.	Natural Area Conservation
Credit 2.	Disconnection of Rooftop Runoff
Credit 3.	Disconnection of Non-Rooftop Runoff
Credit 4.	Sheet Flow to Buffers
Credit 5.	Open Channel Use
Credit 6.	Environmentally Sensitive Development

This chapter describes each of the credits for the six groups of non-structural practices, specifies minimum criteria to be eligible for the credit, and provides an example of how the credit is calculated. Designers should check with the appropriate approval authority to ensure that the credit is applicable to their jurisdiction. Clearly both of the site designs used to illustrate the credits could be more creative to provide more non-structural opportunities.

In general, the stormwater sizing criteria provide a strong incentive to reduce impervious cover at development sites (e.g.,  $Re_v$ ,  $WQ_v$ ,  $Cp_v$  or  $Qp$  and  $Qf$ ). Storage requirements for all five stormwater sizing criteria are directly related to impervious cover. Thus, significant reductions in impervious cover result in smaller required storage volumes and, consequently, lower BMP construction costs.

These and other site design techniques can help to reduce impervious cover, and consequently, the stormwater treatment volume needed at a site. The techniques presented in this chapter are considered options to be used by the designer to help reduce the need for stormwater BMP storage capacity. Due to local safety codes, soil conditions, and topography, some of these site design features will be restricted. Designers are encouraged to consult with the appropriate approval authority to determine restrictions on non-structural strategies.

These credits are an integral part of a project’s overall stormwater management plan and BMP storage volume calculation. Therefore, use of these credits shall be documented at the initial (concept) design stage, documented with submission of final grading plans, and verified with “as-built” certifications. If a planned credit is not implemented, then BMP volumes shall be increased appropriately to meet  $Re_v$ ,  $WQ_v$ ,  $Cp_v$ , and  $Q_p$  where applicable.

**Table 5.1** Summary of Stormwater Credits

Stormwater Credit	$WQ_v$	$Re_v$	$Cp_v$ or $Q_p$
<b>Natural Area Conservation</b>	Reduce Site Area	No credit. Use as receiving area w/Percent Area Method.	Forest/meadow CN for natural areas
<b>Disconnection of Rooftop Runoff</b>	Reduced $R_v$	No credit. Use with Percent Area Method.	Longer $t_e$ (increased flow path). CN credit.
<b>Disconnection of Non-Rooftop Runoff</b>	Reduced $R_v$	No credit. Use with Percent Area Method.	Longer $t_e$ (increased flow path) CN credit
<b>Sheet Flow to Buffers</b>	Subtract contributing site area to BMP	Reduced $Re_v$	CN credit
<b>Open Channel Use</b>	May meet $WQ_v$	Meets $Re_v$	Longer $t_e$ (increased flow path) No CN credit
<b>Environmentally Sensitive Development</b>	Meets $WQ_v$	Meets $Re_v$	No CN credit $t_e$ may increase

**Section 5.1 Natural Area Conservation Credit**

Natural Area Conservation Credit

A stormwater credit is given when natural areas are conserved at development sites, thereby retaining pre development hydrologic and water quality characteristics. A simple  $WQ_v$  credit is granted for all conservation areas permanently protected under conservation easements or other locally acceptable means. Examples of natural area conservation include:

- forest retention areas
- non-tidal wetlands and associated buffers
- other lands in protective easement (floodplains, open space, steep slopes)
- stream systems

Under the credit, a designer can subtract conservation areas from total site area when computing the water quality volume. The volumetric runoff coefficient,  $R_v$ , is still calculated based on the percent impervious cover for the entire site.

As an additional incentive, the post development curve number (CN) used to compute the  $C_{pv}$  or  $Q_{p2}$ , and  $Q_{p10}$  for all natural areas protected by conservation easements can be assumed to be woods in good condition when calculating the total site CN.

As an example, the required  $WQ_v$  for a ten acre site with three acres of impervious area and three acres of protected conservation area before the credit would be:

$$WQ_v = [(P)(R_v)(A)]/12; \text{ where } P=1", R_v=0.05+0.009(30\%)$$

$$WQ_v = [(1") (0.32)(10 \text{ acres})]/12 = 0.266 \text{ acre-feet.}$$

Under the credit, three acres of conservation are subtracted from total site area, which yields a smaller storage volume:

$$WQ_v = [(P)(R_v)(A)]/12; \text{ where } P=1", R_v=0.05+0.009(30\%)$$

$$WQ_v = [(1") (0.32)(10-3 \text{ acres})]/12 = 0.187 \text{ acre-feet.}$$

The recharge requirement ( $R_v$ ) is not reduced using this credit.

**Criteria for Natural Area Credit**

To receive the credit, the proposed conservation area:

- *Shall not be disturbed during project construction (e.g., cleared or graded) except for temporary impacts associated with incidental utility construction or mitigation and afforestation projects,*
- *Shall be protected by having the limits of disturbance clearly shown on all construction drawings and delimited in the field except as provided for above,*
- *Shall be located within an acceptable conservation easement or other enforceable instrument that ensures perpetual protection of the proposed area. The easement must clearly specify how the natural area vegetation shall be managed and boundaries will be marked [Note: managed turf (e.g., playgrounds, regularly maintained open areas) is not an acceptable form of vegetation management], and*
- *Shall be located on the development project.*

**Example of Calculating Natural Area Credit**

Site Data - 51 Single Family Lots  
 Area = 38 ac.  
 Conservation Area = 7.0 ac  
 Impervious Area = 13.8 ac  
 $R_v = .38, P = 0.9"$   
 Post dev. CN = 78  
 Original  $WQ_v = 1.08$  ac-ft.  
 Original  $Re_v = .25$  ac-ft.  
 Original  $Cp_v = 1.65$  ac-ft.  
 Original  $Q_{p10} = 2.83$  ac-ft.

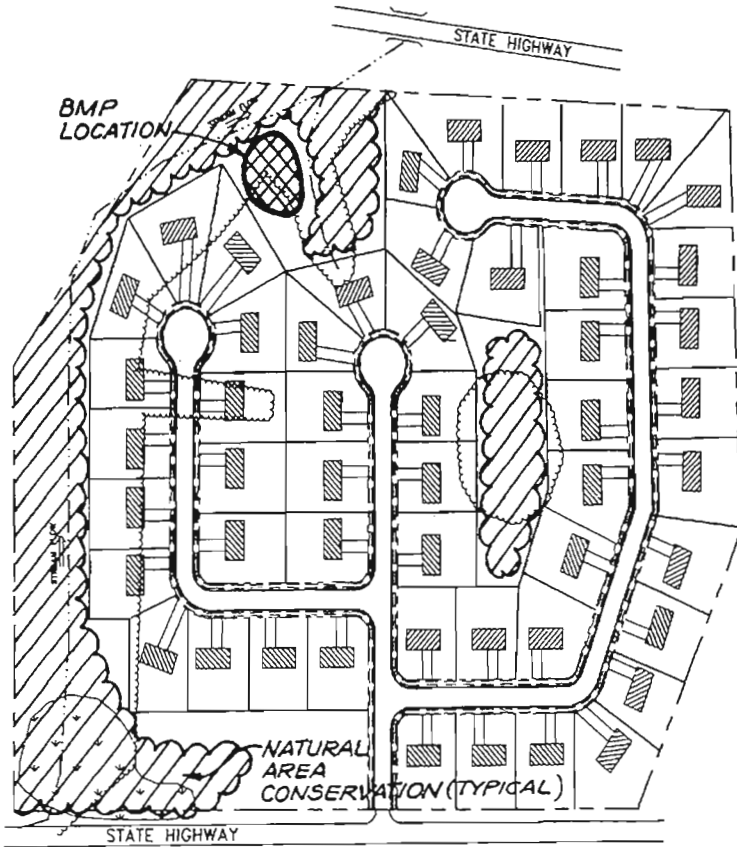

**Computation of Stormwater Credits**

$$WQ_v = [(P)(R_v)(A)]/12$$

$$= [(0.9)(.38)(38.0 - 7.0 \text{ ac.})]/12$$

$$= 0.89 \text{ ac-ft}$$

$Re_v$  = Same as original  
 (However, area draining to Natural Area may used with the Percent Area Method)

$Cp_v$  and  $Q_{p10}$  (total site): CN reduced from 78 to 75

**Section 5.2 Disconnection of Rooftop Runoff Credit**

## Disconnection of Rooftop Runoff Credit

A credit is given when rooftop runoff is disconnected and then directed to a pervious area where it can either infiltrate into the soil or filter over it. The credit is typically obtained by grading the site to promote overland filtering or by providing bioretention areas on single family residential lots.

If a rooftop is adequately disconnected, the disconnected impervious area may be deducted from total impervious cover (therefore reducing  $WQ_v$ ). In addition, disconnected rooftops can be used to meet the  $Re_v$  requirement as a non-structural practice using the percent area method (see Chapter 2).

Post development  $CN$ 's for disconnected rooftop areas used to compute  $Cp_v$  and  $Qp$  can be assumed to be woods in good condition.

**Criteria for Disconnection of Rooftop Runoff Credit**

The credit is subject to the following restrictions:

- *Rooftop cannot be within a designated hotspot,*
- *Disconnection shall cause no basement seepage,*
- *The contributing area of rooftop to each disconnected discharge shall be 500 square feet or less,*
- *The length of the "disconnection" shall be 75' or greater, or compensated using Table 5.2,*
- *Dry wells, french drains, or other underground storage devices may be utilized to compensate for areas with disconnection lengths less than 75 feet. (See Table 5.2 and Figure 5.1, dry wells are prohibited in D soils),*
- *In residential development applications, disconnections will only be credited for lot sizes greater than 6000 sq. ft.,*
- *The entire vegetative "disconnection" shall be on an average slope of 5% or less,*
- *The disconnection must drain continuously through a vegetated channel, swale, or through a filter strip to the property line or BMP,*
- *Downspouts must be at least 10 feet away from the nearest impervious surface to discourage "re-connections", and*
- *For those rooftops draining directly to a buffer, only the rooftop disconnection credit or the buffer credit may be used, not both.*



**Figure 5.1** Schematic of Dry Well

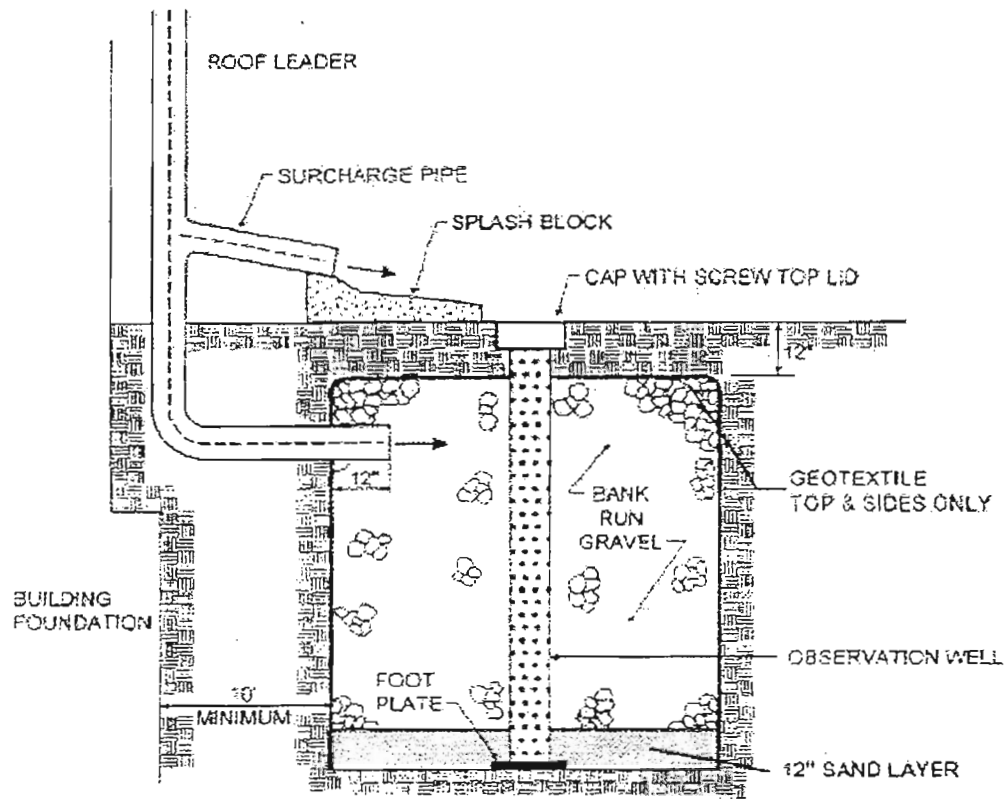

**Table 5.2** Rooftop Disconnection “Drywell” Compensation Storage Volume Requirements (Based on Each Disconnection)

Disconnection Length Provided	0 - 14 ft.	15 - 29 ft.	30 - 44 ft.	45 - 59 ft.	60 - 74 ft.	≥ 75 ft.
% WQ. Treated by Disconnect	0%	20%	40%	60%	80%	100%
% WQ. Treated by Storage	100%	80%	60%	40%	20%	0%
Max. Storage Volume* (Eastern Rainfall Zone)	40 cu-ft.	32 cu-ft.	24 cu-ft.	16 cu-ft.	8 cu-ft.	0 cu-ft.
Max. Storage Volume* (Western Rainfall Zone)	36 cu-ft.	28.8 cu-ft.	21.6 cu-ft.	14.4 cu-ft.	7.2 cu-ft.	0 cu-ft.

\*Assuming 500 square feet roof area to each downspout.

**Example of Using the Rooftop Disconnection Credit**

Site Data - 51 Single Family Lots  
 Area = 38 ac., 1/2 acre lots  
 Original Impervious Area = 13.80 ac.  
 Original  $R_v = .38$   
 Post dev. CN = 78  
 # of Disconnected Rooftops = 22  
 Original  $WQ_v = 1.08$  ac-ft  
 Original  $R_v = 0.25$  ac-ft  
 Original  $Cp_v = 1.65$  ac-ft  
 Original  $Qp_v = 2.83$  ac-ft

60% B Soils  
 40% C Soils  
 Composite  $S=0.208$  (20.8%)

22 Lots Disconnected w/5  
 Downspouts each.  
 $\therefore$  2500 sq. ft. each lot

Net impervious area reduction =  
 $(22)(2500)/43560 = 1.3$  ac

Net Impervious Area =  
 $13.8 - 1.3 = 12.5$  acres

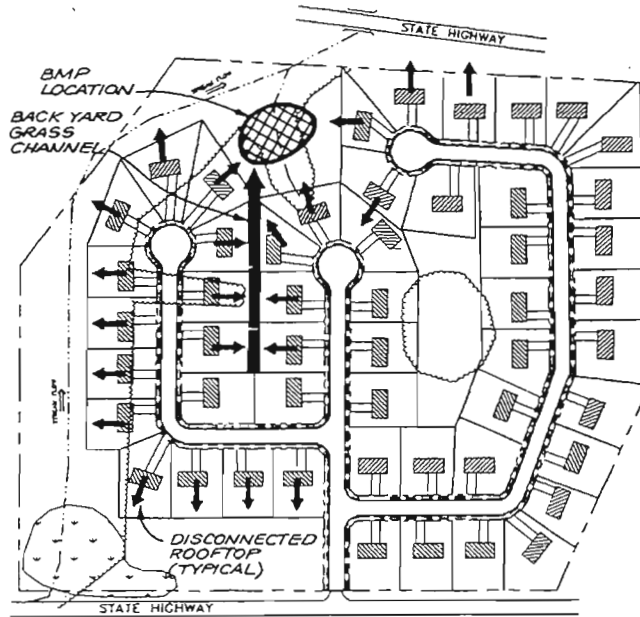

Computation of Stormwater Credit:

New  $R_v = 0.05 + .009 (12.5 \text{ ac}/38 \text{ ac}) = .35$   
 $\therefore WQ_v = [(0.9)(.35)(38 \text{ ac})]/12 = 1.00$  ac-ft.

Required  $R_v$  (Percent Area Method)

$R_v = 20.8\% \times 13.8 \text{ ac.} = 2.87$  acres

$R_v$  treated by disconnection = 1.3 acres

$R_v$  remaining for treatment = 1.57 acres non structurally or 0.14 acre-feet structurally

$Cp_v$  and  $Qp$  (total site): CN reduced from 78 to 76

### Section 5.3 Disconnection of Non Rooftop Runoff Credit

#### Disconnection of Non Rooftop Runoff Credit

Credit is given for practices that disconnect surface impervious cover runoff by directing it to pervious areas where it is either infiltrated into the soil or filtered (by overland flow). This credit can be obtained by grading the site to promote overland vegetative filtering or providing bioretention areas on single family residential lots.

These "disconnected" areas can be subtracted from the impervious area when computing WQ<sub>v</sub>. In addition, disconnected surface impervious cover can be used to meet the Re<sub>v</sub> requirement as a non-structural practice using the percent area method (See Chapter 2).

#### Criteria for Disconnection of Non Rooftop Runoff Credit

The credit is subject to the following restrictions:

- *Runoff cannot come from a designated hotspot.*
- *The maximum contributing impervious flow path length shall be 75 feet.*
- *The disconnection shall drain continuously through a vegetated channel, swale, or filter strip to the property line or BMP.*
- *The length of the "disconnection" must be equal to or greater than the contributing length.*
- *The entire vegetative "disconnection" shall be on an average slope of 5% or less.*
- *The surface impervious area to any one discharge location cannot exceed 1,000 ft<sup>2</sup>.*
- *Disconnections are encouraged on relatively permeable soils (HSG's A and B).*
- *If the site cannot meet the required disconnect length, a spreading device, such as a french drain, gravel trench or other storage device may be needed for compensation, and*
- *For those areas draining directly to a buffer, only the non rooftop disconnection credit or the stream buffer credit can be used, not both.*

**Example of Calculating the Non Rooftop Disconnection Credit**

Site Data -Community Center  
 Area = 3.0 ac  
 Original Impervious Area = 1.9 ac. = 63.3%  
 Original  $R_v = .62$   
 Post dev. CN = 83  
 B Soils,  $S = 0.26$   
 Original  $WQ_v = 6752 \text{ ft}^3$   
 Original  $Re_v = 1688 \text{ ft}^3$   
 Original  $Cp_v = \text{N/A}$   
 Original  $Qp_2 = 10,630 \text{ ft}^3$

0.33 ac of surface imperviousness disconnected

Net impervious area reduction  
 $1.9 - 0.33 = 1.57 \text{ ac.}$

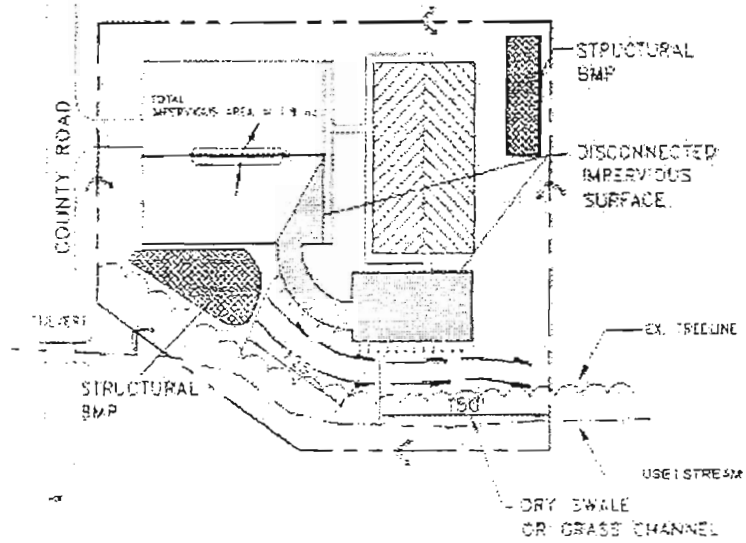

Computation of Stormwater Credit:

New  $R_v = 0.05 + .009 (1.57 \text{ ac}/3.0 \text{ ac}) = .52$   
 $\therefore WQ_v = [(1.0)(0.52)(3.0 \text{ ac})]/12 = 0.13 \text{ ac-ft (5662.8 cf)}$

Required  $Re_v$  (Percent area method)

$Re_v = (S)(A_i) = (0.26)(1.9 \text{ ac.}) = 0.49 \text{ acres}$

$Re_v$  treated by disconnection = 0.33 acres

$Re_v$  remaining for treatment = 0.16 acres non structurally or 551.2 cf structurally

$Cp_v$  and  $Q_p$  Post developed CN may be reduced

**Section 5.4 Sheetflow to Buffer Credit**

## Sheetflow to Buffer Credit

This credit is given when stormwater runoff is effectively treated by a natural buffer to a stream or forested area. Effective treatment is achieved when pervious and impervious area runoff is discharged to a grass or forested buffer through overland flow. The use of a filter strip is also recommended to treat overland flow in the green space of a development site. The credits include:

1. The area draining by sheet flow to a buffer is subtracted from the total site area in the  $WQ_v$  calculation.
2. The area draining to buffer contributes to the recharge requirement, Rev.
3. A *wooded* CN can be used for the contributing area if it drains to a forested buffer.

**Criteria for Sheetflow to Buffer Credit**

The credit is subject to the following conditions:

- *The minimum buffer width shall be 50 feet as measured from bankfull elevation,*
- *The maximum contributing length shall be 150 feet for pervious surfaces and 75 feet for impervious surfaces,*
- *The average contributing overland slope shall be 5.0% or less,*
- *Runoff shall enter the buffer as sheet flow; a level spreading device shall be utilized where sheet flow can no longer be maintained (see Detail No. 9 in Appendix D-8),*
- *Not applicable if rooftop or non rooftop disconnection is already provided (see Credits 2 & 3),*
- *Buffers shall remain unmanaged other than routine debris removal, and*
- *Shall be located within an acceptable conservation easement or other enforceable instrument that ensures perpetual protection of the proposed area. The easement must clearly specify how the natural area vegetation shall be managed and boundaries will be marked [Note: managed turf (e.g., playgrounds, regularly maintained open areas) is not an acceptable form of vegetation management].*

Figure 5.2 illustrates how a buffer or filter strip can be used to treat stormwater from adjacent pervious and impervious areas.

Figure 5.2 Example of Sheetflow to Buffer Credit

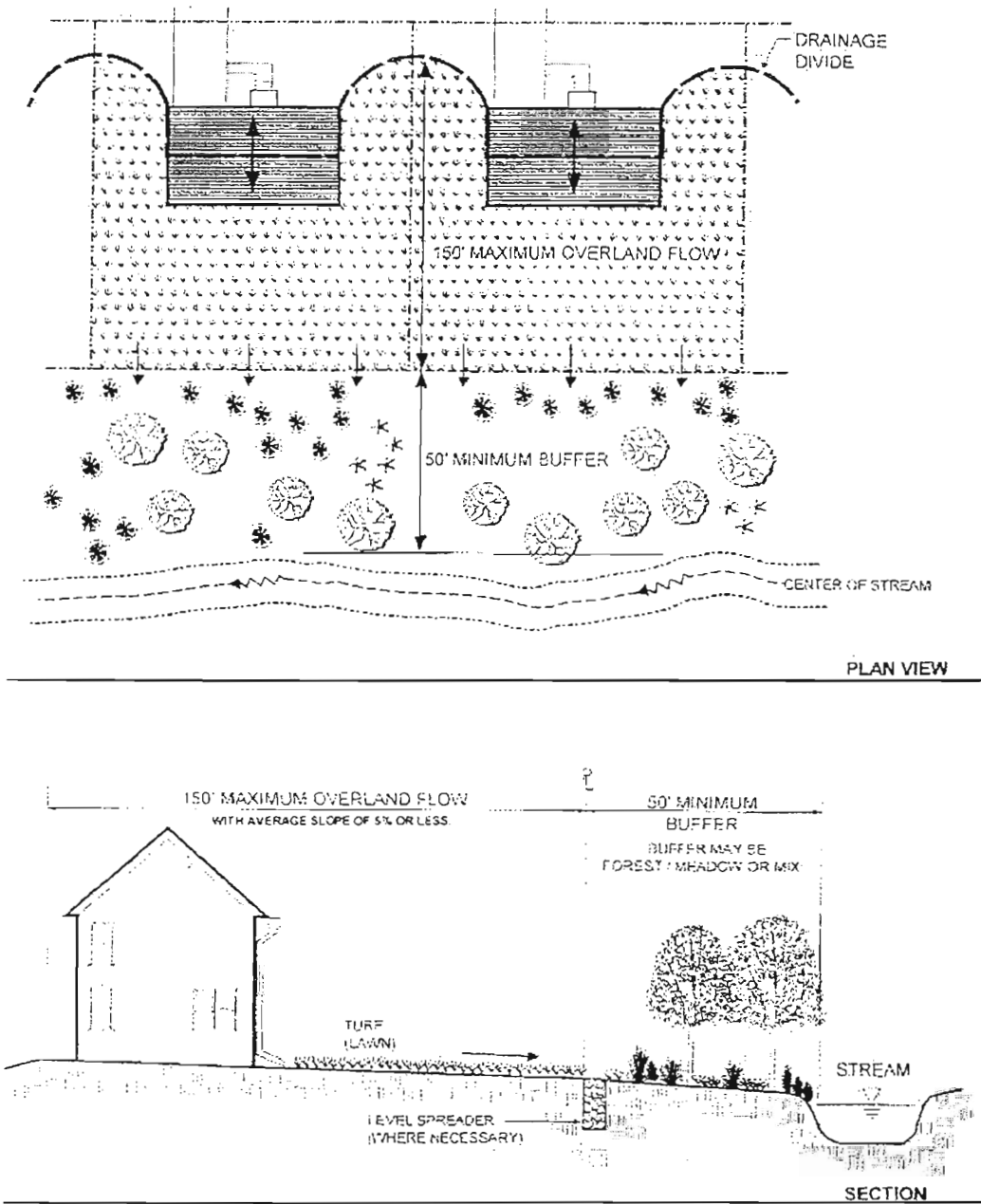

**Example of Using the Sheetflow to Buffer Credit**

Site Data - 51 Single Family  
 Area = 38.0 ac  
 Original Impervious Area =  
 13.8 ac = 36.3%  
 Original  $R_v = .38$   
 Post-dev. CN = 78

Original  $WQ_v = 1.08$  ac-ft  
 Original  $Re_v = 0.24$  ac-ft  
 Original  $Cp_v = 1.65$  ac-ft  
 Original  $Qp_v = 2.83$  ac-ft

Credit  
 5.0 ac draining to  
 buffer/filter strip  
 Rooftops represent 3% of  
 site imperviousness = 0.41  
 acres

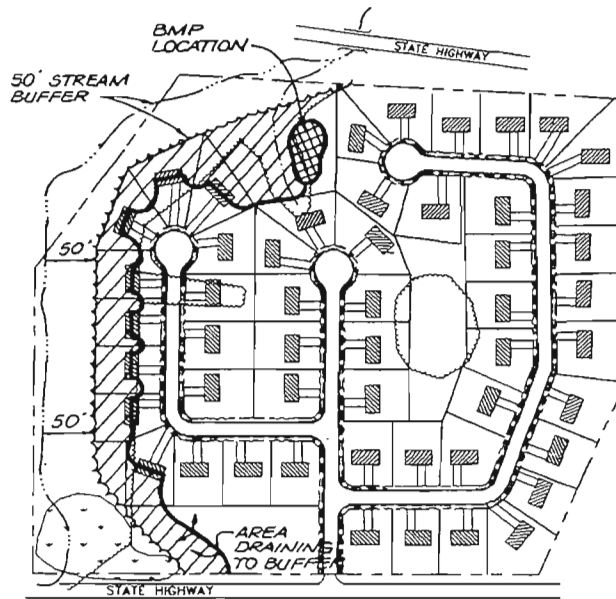

**Computation of Stormwater Credits**

New drainage area = 38 ac. - 5 ac. = 33.0 acres  
 $R_v$  remains unchanged to BMP;  $R_v = 0.05 + 0.009(36.3) = 0.38$

$$WQ_v = [(P)(R_v)(A)]/12$$

$$= [(0.9)(0.38)(33.0 \text{ ac.})]/12$$

$$= 0.94 \text{ ac-ft}$$

Required  $Re_v$  (Percent Area Method)

$$Re_v = 20.8\% \times 13.8 \text{ ac.} = 2.87 \text{ acres}$$

$Re_v$  treated by disconnection = 0.41 acres

$Re_v$  remaining for treatment = 2.46 acres non structurally or 0.214 ac-ft structurally

$Cp_v$  and  $Qp$  (total site): CN is reduced slightly.

### Section 5.5 Grass Channel Credit

Grass Channel Credit (in lieu of Curb and Gutter):

Credit may be given when open grass channels are used to reduce the volume of runoff and pollutants during smaller storms (e.g., < 1 inch). The schematic of the grass channel is provided in Figure 5.3.

Use of a grass channel will automatically meet the  $Re_v$  for impervious areas draining into the channel. However,  $Re_v$  for impervious areas not draining to grass channels must still be addressed. If designed according to the following criteria, the grass channel will meet the  $WQ_v$  as well.

CNs for channel protection or peak flow control ( $Cp_v$  or  $Q_p$ ) will not change.

#### Criteria for the Grass Channel Credit

The  $WQ_v$  credit is obtained if a grass channel meets the following criteria:

- *The maximum flow velocity for runoff from the one-inch rainfall shall be less than or equal to 1.0 fps (see Appendix D-10 for methodology to compute flowrate),*
- *The maximum flow velocity for runoff from the ten-year design event shall be non erosive,*
- *The bottom width shall be 2 feet minimum and 8 feet maximum,*
- *The side slopes shall be 3:1 or flatter,*
- *The channel slope shall be less than or equal to 4.0%, and*
- *Not applicable if rooftop disconnection is already provided (see Credit 2).*

An example of a grass channel is provided in Figure 5.3.



**Figure 5.3** Example of Grass Channel

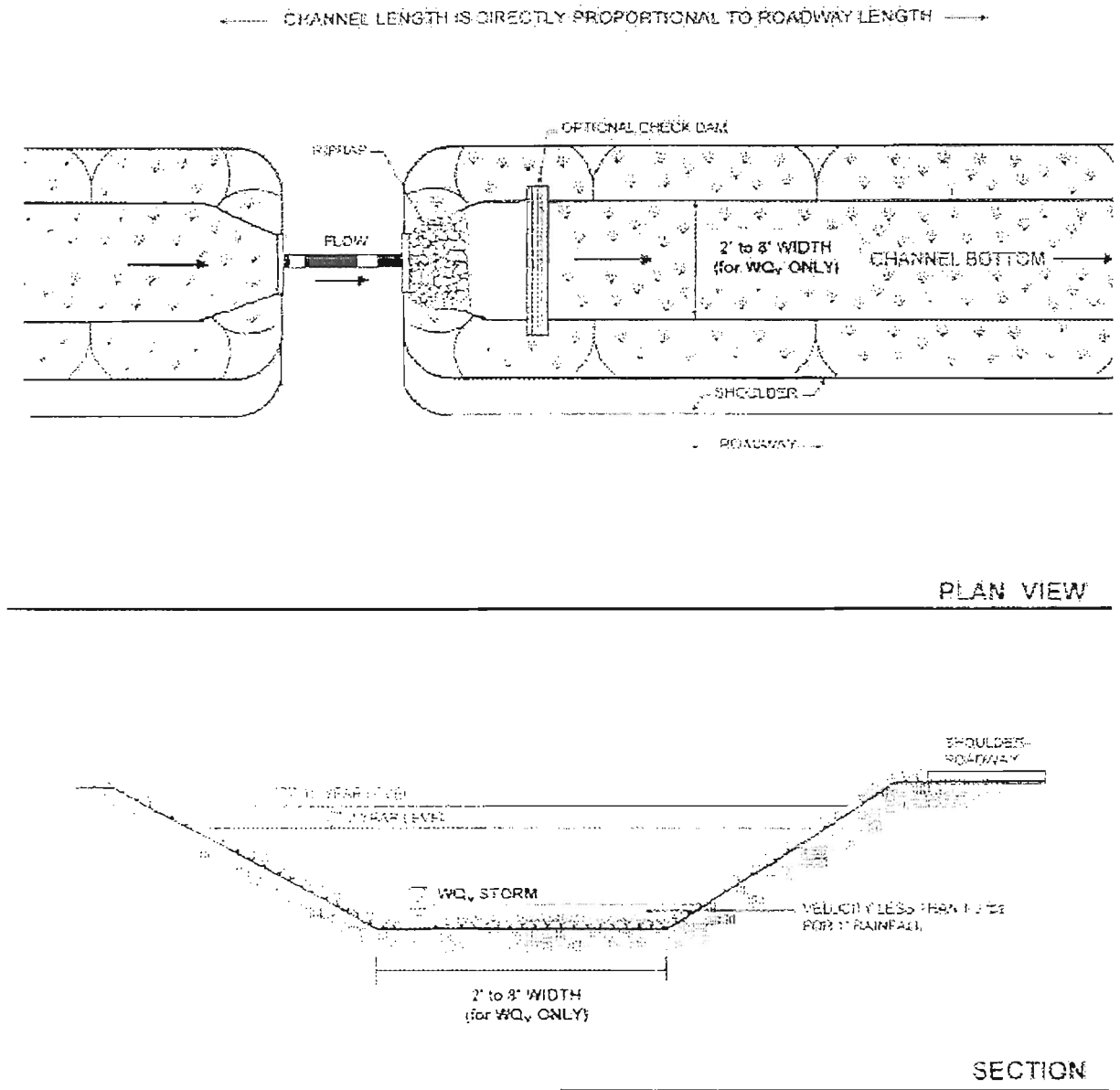

**Example of Grass Channel Credit**

Site Data - 51 Single Family Residences  
 Area = 38.0 ac  
 Original Impervious Area = 13.8 = 36.3%  
 $R_v = .38$   
 $CN = 78$

Original  $WQ_v = 1.08$  ac-ft  
 Original  $Re_v = 0.25$  ac-ft  
 Original  $Cp_v = 1.65$  ac-ft  
 Original  $Qp_v = 2.83$  ac-ft

Credit  
 12.5 acres meet grass channel criteria

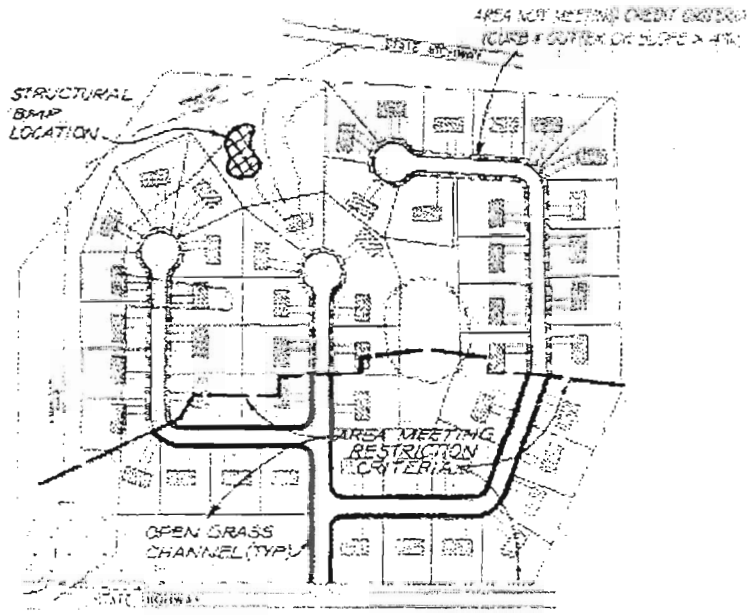

**Computation of Stormwater Credits**

New  $WQ_v$  Area = 38 ac - 12.5 ac = 25.5 ac  
 $WQ_v = [(0.9)(0.38)(25.5 \text{ ac.})]/12$   
 = 0.74 ac-ft

Required  $Re_v$  (Percent Area Method)  
 $Re_v = 20.8\% \times 13.8 \text{ ac.} = 2.87$  acres  
 4.5 acres of imperviousness lie within area drained by grass channels, and  
 4.5 acres > 2.87 acres  
 $\therefore Re_v$  requirement is met.  
 $Cp_v$  and  $Qp_v$ : No change

### Section 5.6 Environmentally Sensitive Development Credit

#### Environmentally Sensitive Development

Credit is given when a group of environmental site design techniques are applied to low density or residential development. The credit eliminates the need for structural practices to treat both the  $Rev$  and  $WQ_v$  and is intended for use on large lots.

#### Criteria for Environmentally Sensitive Development Credit

These criteria can be met without the use of structural practices in certain low density residential developments when the following conditions are met:

For Single Lot Development:

- *total site impervious cover is less than 15%,*
- *lot size shall be at least two acres,*
- *rooftop runoff is disconnected in accordance with the criteria outlined in Section 5.2, and*
- *grass channels are used to convey runoff versus curb and gutter.*

For Multiple Lot Development:

- *total site impervious cover is less than 15%,*
- *lot size shall be at least two acres if clustering techniques are not used,*
- *if clustering techniques are used, the average lot size shall not be greater than 50% of the minimum lot size as identified in the appropriate local zoning ordinance and shall be at least one half acre,*
- *rooftop runoff is disconnected in accordance with the criteria outlined in Section 5.2,*
- *grass channels are used to convey runoff versus curb and gutter,*
- *a minimum of 25% of the site is protected in natural conservation areas (by permanent easement or other similar measure), and*
- *the design shall address stormwater ( $Rev$ ,  $WQ_v$ ,  $Cp_v$ , and/or  $Q_{p10}$ ) for all roadway and connected impervious surfaces.*

**Example of Environmentally Sensitive Development**

Site Data - 1 Single Family Lot  
 Area = 2.5 ac  
 Conservation Area = 0.6 ac  
 Impervious Area = .35 ac (includes adjacent road surface) = 14%  
 B soils  
 Eastern Rainfall Zone for  $WQ_v$   
 $R_v = 0.05 + 0.009(14) = .18$   
 $CN = 65$

$WQ_v$  : Use  $P=0.2$  as  $I < 15\%$   
 $WQ_v = [(0.2)(A)]/12$   
 $= [(0.2)(2.5)]/12 \times (43560 \text{ ft}^2/\text{ac.})$   
 $= 1,815 \text{ ft}^3$   
 $Rev = [(S)(R_v)(A)]/12$   
 $= [(0.26)(0.18)(2.5)]/12 \times (43,560 \text{ ft}^2/\text{ac.})$   
 $= 424.7 \text{ ft}^3$

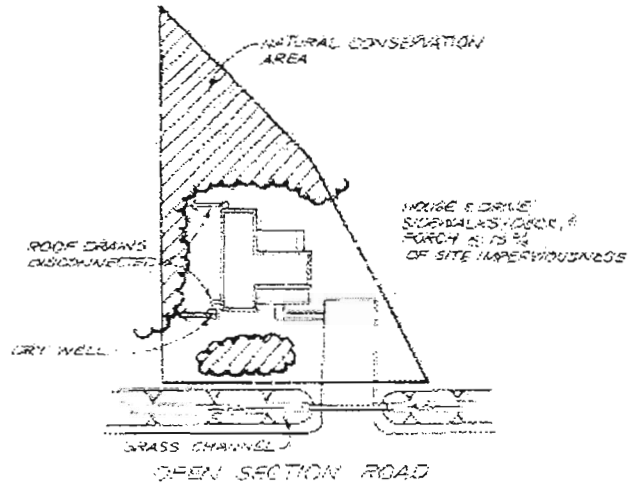

Computation of Stormwater Credits:

$WQ_v$  is met by site design  
 $Rev$  is met by site design  
 $Cp_v$  and  $Qp$ : No change in  $CN$ ,  $t_c$  may be longer which would reduce  $Qp$  requirements

### Section 5.7 Dealing with Multiple Credits

Site designers are encouraged to utilize as many credits as they can on a site. Greater reductions in stormwater storage volumes can be achieved when many credits are combined (e.g., disconnecting rooftops and protecting natural conservation areas). However, credits cannot be claimed twice for an identical area of the site (e.g. claiming credit for stream buffers and disconnecting rooftops over the same site area).

### Section 5.8 Other Strategies to Reduce Impervious Cover

Definition: Site planning practices that reduce the creation of impervious area in new residential and commercial development and therefore reduce the  $WQ_v$  for the site.

Examples of progressive site design practices that minimize the creation of impervious cover include:

- Narrower residential road sections
- Shorter road lengths
- Smaller turnarounds and cul-de-sac radii
- Permeable spill-over parking areas
- Smaller parking demand ratios
- Smaller parking stalls
- Angled one way parking
- Subdivisions with open space
- Smaller front yard setbacks
- Shared parking and driveways
- Narrower sidewalks

It should be noted that most site designers may have little ability to control these requirements, which are typically enshrined in local subdivision, parking and/or street codes.

Where these techniques are employed, it may be possible to reduce stormwater storage volumes. For example, because the  $WQ_v$  is directly based on impervious cover, a reduction in impervious cover reduces  $WQ_v$ . For  $C_p$  and  $Q_p$ , the designer can compute curve numbers (CN) based on the actual measured impervious area at a site using:

$$CN = \frac{(98)I + \sum (CN)(P)}{A}$$

where:

$CN$  = curve number for the appropriate pervious cover

$I$  = impervious area at the site

$P$  = pervious area at the site

$A$  = total site area

## APPENDIX D

### Natural Resource Fact Sheets

Fact sheets are designed to be stand alone tools that can be copied and shared to help inform others on the issues.





## Fact Sheet -- Stormwater Runoff, Lost Resource or Community Asset? **Floodplains and their Environmental Functions**

A floodplain is the low, flat, periodically flooded area adjacent to rivers, lakes, and oceans.<sup>1</sup> Floodplains are subject to geomorphic (land shaping) and hydrologic (water flow) processes.<sup>2</sup> The floodplain is a sponge that absorbs water, filters it, and helps captured floodwater to infiltrate through the soil so that the groundwater aquifer below is replenished. A complex physical and biological system, the floodplain and its stream support a variety of natural resources.<sup>3</sup>

The 100-year floodplain is the area along a waterway that is expected to be or has been inundated in a 100-year frequency flood. This means the 100-year flood has a one-in-one-hundred or one percent chance of being equaled or exceeded in any year. The 100-year frequency flood serves as the standard for most regulations.

Inside the floodplain is the floodway. The floodway is the most dangerous area of the floodplain and is the most strictly regulated for all obstructions. It is that portion of the channel of a waterway that carries the deeper, faster waters. The delineation of the floodway is established by specific calculations by the Federal Emergency Management Agency (FEMA). State environmental regulations also define and regulate the floodway.<sup>4</sup>

Floodplains occupy a significant portion of the United States. About 7 percent, or 178 million acres, of all U.S. land is floodplain, and, of course, the percentages are much higher along the coasts and major rivers, where most of the larger cities are located.<sup>5</sup> Floodplains are shaped by water-related, dynamic physical and biological processes and include many of the nations most beautiful landscapes, most productive wetlands, and most fertile soils.<sup>6</sup> They are home to many rare and endangered plants and animals, as well as sites of archeological and historical significance. In their natural state, floodplains have substantial value.<sup>7</sup> These complex, dynamic systems contribute to the physical and biological support of water resources, living

---

<sup>1</sup> "Beyond Flood Control: Flood Management and River Restoration", May, 1997, Friends of the River, Sacramento, CA

<sup>2</sup> "Beyond Flood Control: Flood Management and River Restoration", May, 1997, Friends of the River, Sacramento, CA

<sup>3</sup> "Beyond Flood Control: Flood Management and River Restoration", May, 1997, Friends of the River, Sacramento, CA

<sup>4</sup> "Technical Information on Floodplain Management, Administrative Guidelines for Development, Planning Series 11", Department of Community and Economic Development, Commonwealth of Pennsylvania

<sup>5</sup> Kusler and Larson, "Beyond the Ark, A New Approach to U.S. Floodplain Management". Reprinted from River Voices, River Network, Portland, OR, Winter, 1994, from an article originally printed I Environment, Vol. 35, No. 5, June 1993

<sup>6</sup> Kusler and Larson, "Beyond the Ark, A New Approach to U.S. Floodplain Management". Reprinted from River Voices, River Network, Portland, OR, Winter, 1994, from an article originally printed I Environment, Vol. 35, No. 5, June 1993

<sup>7</sup> Kusler and Larson, "Beyond the Ark, A New Approach to U.S. Floodplain Management". Reprinted from River Voices, River Network, Portland, OR, Winter, 1994, from an article originally printed I Environment, Vol. 35, No. 5, June 1993





resources, and cultural resources.<sup>8</sup> They provide natural flood and erosion control, help maintain high water quality, and contribute to sustaining groundwater supplies. Proper management of floodplains is important to preserve their value and to reduce losses caused by flooding.<sup>9</sup>

The natural state of a floodplain is to be covered in native vegetation, to contain no structures, to be connected to the waterway and its wetlands, and to be left unobstructed. It is important to keep floodplains in their natural state so that they can function as nature intended. When a floodplain is built on or compromised in any way, its ability to function is diminished and we are forced to devise alternative means of replacing those functions. There are many best management practices that engineers have developed to mimic the floodplain's function. However, there is simply no substitute for the floodplains' natural performance in protecting the environment and reducing flooding downstream. And research shows that leaving the floodplain intact is the most cost-beneficial way to meet those needs.

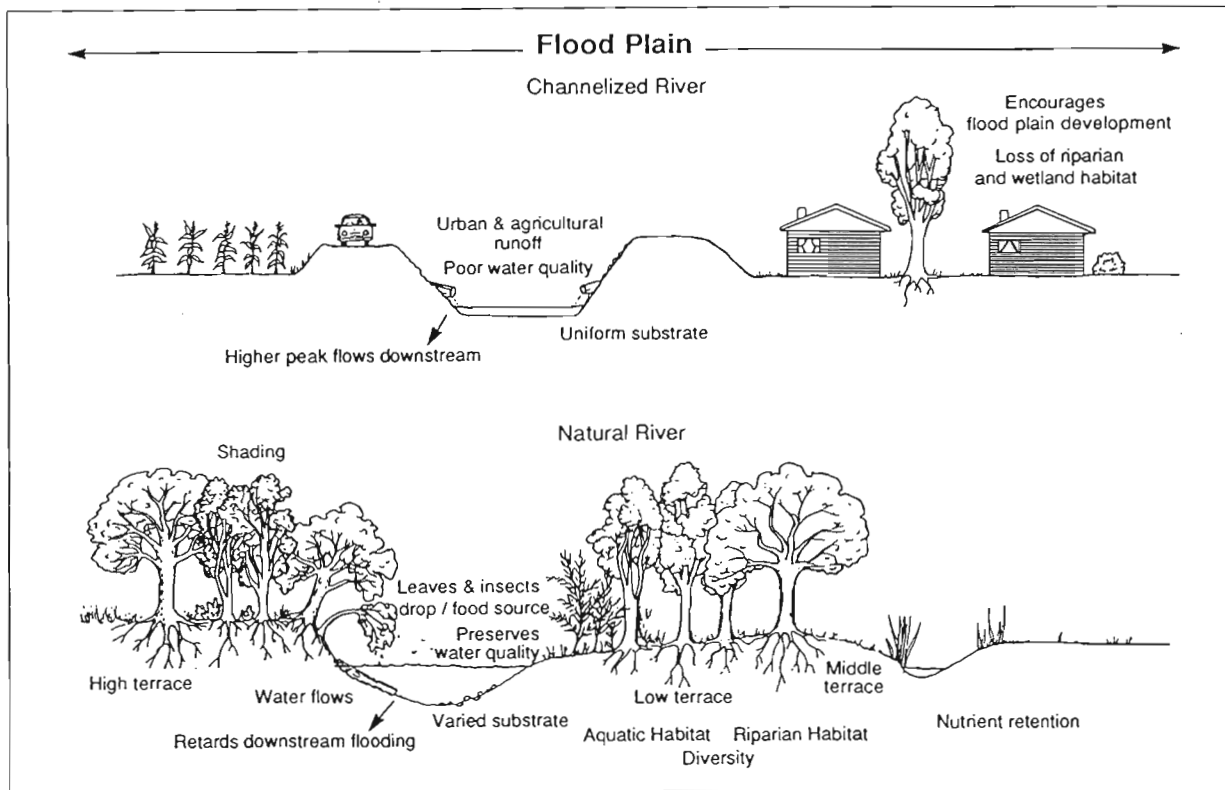

Natural versus Channelized River.

*Reprinted from "California's Rivers a Public Trust Report",  
Prepared for the California State Lands Commission, 1993.*

<sup>8</sup> Kusler and Larson, "Beyond the Ark, A New Approach to U.S. Floodplain Management". Reprinted from River Voices, River Network, Portland, OR, Winter, 1994, from an article originally printed in Environment, Vol. 35, No. 5, June 1993

<sup>9</sup> Kusler and Larson, "Beyond the Ark, A New Approach to U.S. Floodplain Management". Reprinted from River Voices, River Network, Portland, OR, Winter, 1994, from an article originally printed in Environment, Vol. 35, No. 5, June 1993



Floodplains vegetated with trees and shrubs can be four times as effective at retarding flood flows as grassy areas.<sup>10</sup> In addition, naturally vegetated floodplains provide breeding and feeding grounds for both fish and wildlife, they "create and enhance waterfowl habitat", and they "protect habitat for rare and endangered species."<sup>11</sup> Naturally vegetated floodplains are generally layered with leaf and organic matter which result in organic soils with high porosity and a greater capacity for holding water.<sup>12</sup> The floodplain, in this natural state, is a riparian ecosystem that needs the overbank flows that the natural watershed's hydrology provides in order to remain healthy and in balance.<sup>13</sup>

The Delaware River's health and the health of its tributary streams are threatened by loss of its floodplain's function and the resulting increase in stormwater and floodwater.

Think of the floodplain as a giant sponge. Every impervious surface (through which rain cannot percolate), every building that is built in the floodplain, fills up some of the pores of that sponge. As the pores are filled in, the sponge loses, bit by bit, its ability to soak up and store water; it can no longer function. The floodplain becomes static, disconnected from its river and is no longer a living part of that dynamic system. Those who live downstream of a filled-in floodplain suffer increased flood damages as flood flows and velocity increase.

Federal and State agencies are beginning to realize the irreplaceable role of floodplains in flood damage control and are beginning to more carefully regulate development in the floodplain. The Army Corps of Engineers, the Federal Emergency Management Agency, the Natural Resources Conservation Service, the Environmental Protection Agency, and the U.S. Geologic Survey, all have newly created initiatives to remove structures from floodplains and recommend against further building in the floodplain. The economics of flood control are the moving force for these changes. Despite the \$140 billion in federal tax monies spent on recovering from natural disasters in the past 25 years, flood damages continue to rise each year.<sup>14</sup> In the past 5 years, flood damages have exceeded \$40 billion, well above any past period.<sup>15</sup> These government agencies are beginning to realize that the most effective way to

---

<sup>10</sup> DNREC and Brandywine Conservancy, Conservation Design for Stormwater Management: A Design Approach to Reduce Stormwater Impacts from Land Development and Achieve Multiple Objectives Related to Land Use, September, 1997, p. 2-15

<sup>11</sup> DNREC and Brandywine Conservancy, Conservation Design for Stormwater Management: A Design Approach to Reduce Stormwater Impacts from Land Development and Achieve Multiple Objectives Related to Land Use, September, 1997, p. 2-15

<sup>12</sup> DNREC and Brandywine Conservancy, Conservation Design for Stormwater Management: A Design Approach to Reduce Stormwater Impacts from Land Development and Achieve Multiple Objectives Related to Land Use, September, 1997, p. 2-15

<sup>13</sup> Poff, Allan, Bain, Karr, Prestergaard, Richter, Sparks, and Stromberg, "The Natural Flow Regime", BioScience, Vol. 47, No. 11

<sup>14</sup> National Wildlife Federation, Higher Ground, A Report on Voluntary Property Buyouts in the Nation's Floodplains, July 1998

<sup>15</sup> "Flood Policy and Flood Management: A Post-Galloway Progress Report", River Voices, Vol 8, No. 2, Summer, 1997



reduce flood damages and loss of life is to remove structures from the floodplain and keep floodplains natural.

According to the U.S. Environmental Protection Agency, the number one source of pollution to our nation's waterways is from nonpoint sources, including pollution from floodwaters, washed from the land in stormwater runoff.<sup>16</sup> About 40% of the nation's waterways are polluted as a result.<sup>17</sup> Floodplains play a key role in reducing stormwater flows and containing floods, filtering out nonpoint source pollution, thereby reducing pollutant loading and protecting water quality.

The Benefits of Vegetated Natural Floodplain:

- ✓ Stores and slows floodwaters;
- ✓ Intercepts overland flows, capturing sediment;
- ✓ Stabilizes streambanks, preventing erosion;
- ✓ Protects wetlands and other critical habitats;
- ✓ Replenishes groundwater aquifer;
- ✓ Filters out pollution;
- ✓ Provides recreation and education;
- ✓ Trees and other vegetation: provide wildlife habitat; process nutrients and other would-be pollutants; shade and cool waterways; provide food for wildlife and stream insects (detritus); provide beauty and refuge.

**Delaware Riverkeeper Network**

*Working since 1988 to protect and restore the Delaware River, its tributaries and habitats.*

**P.O. Box 326, Washington Crossing, PA 18977**

**215-369-1188**

**delawareriverkeeper.org**

<sup>16</sup> Chester L. Arnold Jr., and C. James Gibbons, "Impervious Surface Coverage, the Emergence of a Key Environmental Indicator", APA Journal, Spring 1996, p. 245

<sup>17</sup> Chester L. Arnold Jr., and C. James Gibbons, "Impervious Surface Coverage, the Emergence of a Key Environmental Indicator", APA Journal, Spring 1996, p. 245



## Fact Sheet -- Stormwater Runoff, Lost Resource or Community Asset?

# Wetlands: Natural Wonders in Need of Protection

Wetlands are among the most productive ecosystems on earth.<sup>1</sup> Wetlands provide critical habitat for fish, wildlife, amphibians and birds. Natural wetlands are usually heavily vegetated and serve as a natural filter for runoff.<sup>2</sup> And, wetlands help control stormwater.

### Wetlands are Alive

Wetlands provide productive and diverse ecosystems for both aquatic and terrestrial wildlife<sup>3</sup> and they produce biomass for the base of the food chain.<sup>4</sup> "A fresh marsh is as productive as a tropical rainforest."<sup>5</sup> Wetlands of all sizes, both large and small, have been demonstrated to provide important habitat for a wide variety of plants and animals, many of which could not survive without them.<sup>6</sup> Forty-two percent of the "total U.S. threatened and endangered species depend upon wetlands for survival."<sup>7</sup> Wetlands provide a diverse and complex set of ecosystems -- niches that function as an irreplaceable ecological unit.<sup>8</sup>

### Wetlands Clean Our Streams

Wetlands act as a natural pollution filter thereby providing irreplaceable water quality benefits. They often function as a buffer or filter that protects waterways from pollution washed from the land. The dense vegetation found in wetlands filters out sediment, nutrients and other pollutants.<sup>9</sup> Wetlands can also filter pesticides and heavy metals and can reduce water-borne bacterial contamination through microbial action.<sup>10</sup>

### Wetlands are Natural Sponges

Wetlands provide flood control, erosion control and groundwater recharge. They play an important part in nature's absorption of and distribution of water in the natural ecosystem. Wetlands are part of nature's sponge, holding water, feeding plants, and slowly recharging

---

<sup>1</sup> "America's Wetlands, Our Vital Link Between Land and Water", US EPA Office of Wetlands Protection, Office of Water, Doc. No. OPA-87-016, February 1988, p. 4

<sup>2</sup> Wetlands Fact Sheets, US EPA, Document Number EPA843-F-95-001, February 1995

<sup>3</sup> National Wildlife Federation Fact Sheet -- [nwf.org/wetlands/facts/benefits.html](http://nwf.org/wetlands/facts/benefits.html)

<sup>4</sup> Michael J. Caduto, Pond and Brook, A Guide to Nature in Freshwater Environments, University Press of New England, 1985, p. 29

<sup>5</sup> Michael J. Caduto, Pond and Brook, A Guide to Nature in Freshwater Environments, University Press of New England, 1985

<sup>6</sup> National Wildlife Federation, "Status Report of Our Nation's Wetlands", October 1987.

<sup>7</sup> DNREC and Brandywine Conservancy, Conservation Design for Stormwater Management: A Design Approach to Reduce Stormwater Impacts from Land Development and Achieve Multiple Objectives Related to Land Use, September, 1997, p. 2-11.

<sup>8</sup> National Wildlife Federation, "Status Report of Our Nation's Wetlands", October 1987.

<sup>9</sup> Clean Water Network and NRDC, "Wetlands for Clean Water, How Wetlands Protect Rivers, Lakes and Coastal Waters from Pollution", April 1997

<sup>10</sup> Clean Water Network and NRDC, "Wetlands for Clean Water, How Wetlands Protect Rivers, Lakes and Coastal Waters from Pollution", April 1997



aquifers. Wetlands effectively absorb and hold floodwaters thereby protecting adjacent and downstream properties from flood damage.<sup>11</sup> Depending on the soil type, wetlands can contain 1 million to 1.5 million gallons of water per acre, thereby alleviating flooding by holding excess water like a sponge.<sup>12</sup> At the same time, wetland vegetation helps to slow the speed of floodwaters -- this in combination with the storage capabilities of wetlands can both lower flood heights and reduce the erosive potential of floodwaters.<sup>13</sup> Wetlands can also desynchronize flood peak flows and velocities during small runoff events.<sup>14</sup>

"Wetlands within and upstream of urban areas are especially valuable for flood protection, since urban development increases the rate and volume of surface-water runoff, thereby increasing the risk of flood damage.<sup>15</sup> Conversely, removal of wetlands can increase downstream flooding.<sup>16</sup>

### **Wetlands are Under Siege**

Despite their tremendous value, more than half of America's original wetlands have been lost to development, agriculture, mining, hydrology alterations and pollution.<sup>17</sup> And, each year we continue to decimate nearly 500,000 additional acres of wetlands.<sup>18</sup>

According to USEPA, nonpoint source pollution from runoff is destroying the function of wetlands across the nation, with siltation accounting for nearly half of the existing wetland acreage that is adversely impacted. The State of Delaware reported that all of the designated uses of wetlands in that state are undercut by nonpoint source pollution.<sup>19</sup> This is most likely typical of all Delaware River watershed states.

Loss of wetlands increases soil erosion, damages water quality and allows increased sedimentation and polluted runoff into streams.<sup>20</sup> Increased stormwater flows can upset the

<sup>11</sup> "America's Wetlands, Our Vital Link Between Land and Water", US EPA Office of Wetlands Protection, Office of Water, Doc. No. OPA-87-016, February 1988, p. 4

<sup>12</sup> Bob Schildgen, "Unnatural Disasters", *Sierra*, June 1999

<sup>13</sup> "America's Wetlands, Our Vital Link Between Land and Water", US EPA Office of Wetlands Protection, Office of Water, Doc. No. OPA-87-016, February 1988, p. 4

<sup>14</sup> DNREC and Brandywine Conservancy, Conservation Design for Stormwater Management: A Design Approach to Reduce Stormwater Impacts from Land Development and Achieve Multiple Objectives Related to Land Use, September, 1997, p. 2-12

<sup>15</sup> "America's Wetlands, Our Vital Link Between Land and Water", US EPA Office of Wetlands Protection, Office of Water, Doc. No. OPA-87-016, February 1988, p. 4.

<sup>16</sup> DNREC and Brandywine Conservancy, Conservation Design for Stormwater Management: A Design Approach to Reduce Stormwater Impacts from Land Development and Achieve Multiple Objectives Related to Land Use, September, 1997, p. 2-12

<sup>17</sup> "America's Wetlands, Our Vital Link Between Land and Water", US EPA Office of Wetlands Protection, Office of Water, Doc. No. OPA-87-016, February 1988, p. 6.

<sup>18</sup> Michael J. Caduto, Pond and Brook, A Guide to Nature in Freshwater Environments, University Press of New England, 1985

<sup>19</sup> "Managing Nonpoint Source Pollution", Final Report to Congress on Section 319 of the Clean Water Act, USEPA, 1992, p.24

<sup>20</sup> Clean Water Network and NRDC, "Wetlands for Clean Water, How Wetlands Protect Rivers, Lakes and Coastal Waters from Pollution", April 1997



"dynamic equilibrium" that exists between wetlands and the surrounding watershed. Changes in volume or quality of runoff to wetlands can affect the biological community and ecological functions of a wetland. Generally, wetlands work as an integrated system with other wetlands in a watershed. When assessing the value, or lost value, of wetlands, it is important to recognize this critical interrelationship.<sup>21</sup>

Using conservation design practices, wetlands areas can be protected both from direct destruction as well as slow destruction such as occurs when development alters the hydrologic system and can disrupt the water features that support and nurture a wetlands' existence. Protecting and/or creating buffer areas around wetlands provides vegetation that can filter out sediments and other pollutants which might otherwise overwhelm a wetland system. Wetland buffers also help protect wetlands from being overwhelmed by surface runoff, provide room for a wetland to naturally migrate, help protect existing wetlands vegetation and habitats from encroachment, and can provide needed habitat to species dependent upon the wetland and adjacent uplands for their life cycle and survival.



### **Delaware Riverkeeper Network**

*Working since 1988 to protect and restore the Delaware River, its tributaries and habitats.*

**P.O. Box 326, Washington Crossing, PA 18977**

**215-369-1188**

**delawareriverkeeper.org**

<sup>21</sup> "America's Wetlands, Our Vital Link Between Land and Water", US EPA Office of Wetlands Protection, Office of Water, Doc. No. OPA-87-016, February 1988, p. 4



Fact Sheet -- Stormwater Runoff, the Lost Resource  
**Large Woody Debris in Our Streams --  
Enhancing Environmental Health,  
Not Local Flooding**

Large branches, logs and other large woody debris found in our stream systems are important to the ecological health of our stream systems.<sup>1</sup> It is not true that large woody debris must be regularly cleaned from a stream in order to relieve flooding.

Large woody debris performs a number of critical functions in the health of a stream ecosystem:

- ✓ Large woody debris provides fish with: protection from high velocities; shade; shelter; food and important nursery, spawning and refuge areas.<sup>2</sup>
- ✓ Large woody debris provides other aquatic and terrestrial organisms including invertebrates, birds, reptiles and mammals with critical food, shelter, crossing areas, and resting areas.<sup>3</sup>
- ✓ Large woody debris provides a substrate needed for biofilm that decomposes the wood and, in so doing, adds dissolved and particulate organic materials and carbon to the water column, providing food for fish and invertebrates.<sup>4</sup>
- ✓ The snags created by large woody debris add turbulence to the stream which contribute needed oxygen to the water.<sup>5</sup>
- ✓ Large woody debris helps protect and stabilize the streambed and banks, protecting them from erosion.<sup>6</sup>

It is a commonly held misconception that large woody debris exacerbates flooding and should be removed from a stream system. Only large woody debris that is oriented perpendicular to

---

<sup>1</sup> Moses and Morris, "Geomorphic Insight and Successful Stream Corridor Rehabilitation in Heavily Impacted Watersheds," *International Conference on Riparian Ecology and Management in Multi-Land Use Watersheds*, Conference Proceedings, American Water Resources Association, August 28-31, 2000.

<sup>2</sup> "Managing Snags and Large Woody Debris", *River Crossings*, Mississippi Interstate Cooperative Resource Association, July/August 2000, pgs 10-11.

<sup>3</sup> "Managing Snags and Large Woody Debris", *River Crossings*, Mississippi Interstate Cooperative Resource Association, July/August 2000, pgs 10-11.

<sup>4</sup> "Managing Snags and Large Woody Debris", *River Crossings*, Mississippi Interstate Cooperative Resource Association, July/August 2000, pgs 10-11.

<sup>5</sup> "Managing Snags and Large Woody Debris", *River Crossings*, Mississippi Interstate Cooperative Resource Association, July/August 2000, pgs 10-11.

<sup>6</sup> "Managing Snags and Large Woody Debris", *River Crossings*, Mississippi Interstate Cooperative Resource Association, July/August 2000, pgs 10-11.





the flow of the stream and covers more than 10% of the channel cross section "causes substantial local water level increases and increases the chance of water overflowing stream banks during flood flows."<sup>7</sup> In all other instances the debris has little or no impact on local water levels.<sup>8</sup>

The presence of large woody debris in the life cycle and health of a stream is critical. Removal of this debris destroys critical food, habitat, stream ecology and protection from erosive forces to both the stream and aquatic life.

### **Delaware Riverkeeper Network**

*Working since 1988 to protect and restore the Delaware River, its tributaries and habitats.*

**P.O. Box 326, Washington Crossing, PA 18977**

**215-369-1188**

**delawareriverkeeper.org**

---

<sup>7</sup> "Managing Snags and Large Woody Debris", River Crossings, Mississippi Interstate Cooperative Resource Association, July/August 2000, pgs 10-11.

<sup>8</sup> "Managing Snags and Large Woody Debris", River Crossings, Mississippi Interstate Cooperative Resource Association, July/August 2000, pgs 10-11.



## Fact Sheet – Protecting your Home Waters

# “Green” yards protect streams

All across the Delaware River watershed communities are expanding, new developments are appearing, and the amount of land laid with green grass carpet is growing. At the same time floodwaters are rising, streambanks are eroding, drinking wells are running dry and water quality is on the decline. There is a direct connection between what happens in our back yards and what happens in our local streams.

When vegetated with native trees and shrubs, when covered in a blanket of decaying leaves, needles and wood, the land acts as a sponge. Rainwater can percolate into the soil and filter

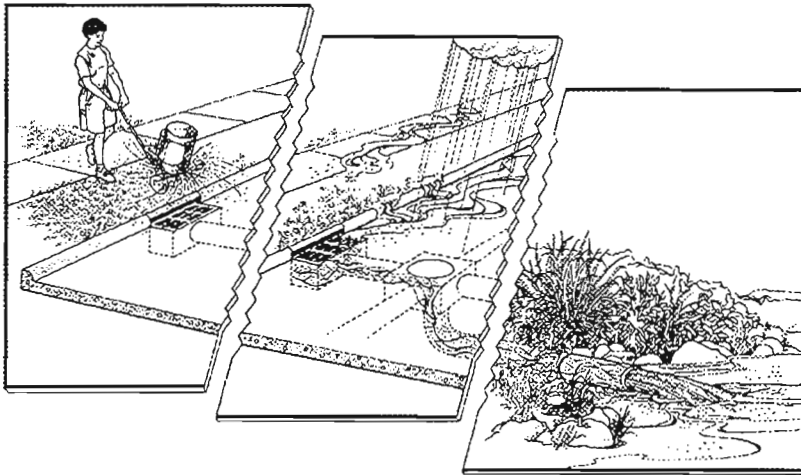

down to the water table below to re-supply the aquifers that provide our drinking water. Rainwater also provides base flow to our streams, creeks and rivers. The landscape, in this natural state, is alive with life – birds sing in the trees, squirrels dance across the ground, bugs revel in the earth. Our lives are richer and our water flows free and clean.

Lands vegetated only with grass cannot perform the functions of the natural landscape. Lawns don't act as sponges. They more closely

resemble sidewalks and roadways – limiting groundwater infiltration and causing rainwater to run off the site, carrying with it any excess or improperly applied fertilizers and pesticides. This runoff is then channeled, usually by roads or conventional detention basins, to a nearby storm drain, which is likely receiving runoff from other roadways, lawns and communities. Stormwater runoff travels through storm sewers to a local creek where it combines with the runoff from all other upstream communities. More and more frequently, downstream communities are suffering from the effects of the upstream loss of open space and vegetation; they are suffering from the loss of the land's natural sponge. Downstream communities are getting flooded out as the result of the increased stormwater flows. Moreover, without the slow filtration of rainwater through the ground to the water table and aquifers below, drinking wells can run dry and the base flow of streams is compromised because there is less fresh water to flow into the stream.

Stormwater picks up energy as it moves through storm sewers. As a result, it is often discharged with greater velocity and, when infiltration is reduced, in greater quantities than the local stream can handle. Rainwater once held on the land and released slowly now flushes into the receiving stream from a pipe, with every additional storm drain increasing the impacts.

The influx of fast-moving stormwater scours and undermines streambanks – many of which are vulnerable to erosion due to clearing and mowing of streamside vegetation. The scoured sediments turn the stream a chocolate brown, depriving fish and plants of light. When the sediments do settle, they smother streambeds where fish lay their eggs and which also serve as home for aquatic macroinvertebrates, important components of the food chain.

Stormwater detention basins, as they are presently constructed, do little to alleviate problems associated with runoff – in fact they can contribute to them. Detention basins, which send runoff directly to local streams, do not reduce the amount of runoff and they may not reduce the velocity with which it enters the local creek. Detention basins serve only to reduce peak flows of stormwater runoff, and ultimately prolong the harmful impacts of the storm event on neighboring and downstream communities.

Most of us enjoy a grassy area in our yards – a place to play, sunbathe or read. We can continue to enjoy our place in the sun while reducing the total amount of lawn we must maintain. By re-vegetating little used grassy areas and adding a perimeter of native trees, shrubs and plants we can greatly enhance the quality of our lives. Through these simple landscaping practices we can improve local water quality, contribute to flood relief for downstream communities, provide habitat for birds and wildlife, bring privacy and peace to our own back yards while still allowing for the lawns many people so love to mow.

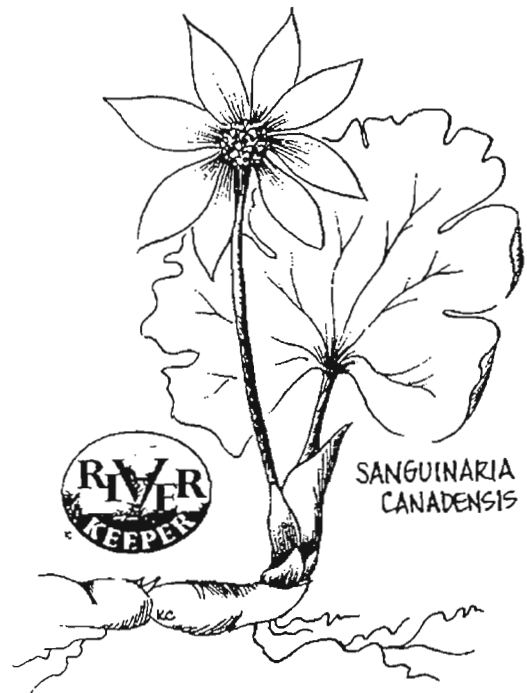

### **Delaware Riverkeeper Network**

*Working since 1988 to protect and restore the Delaware River, its tributaries and habitats.*

**P.O. Box 326, Washington Crossing, PA 18977**

**215-369-1188**

**delawareriverkeeper.org**

*Delaware Riverkeeper Network*



**1-800-8-DELAWARE**

Fact Sheet – Protecting your Home Waters

## Plant a native landscape

The average suburban property contains a lot of lawn that really isn't used for anything. You can make a valuable contribution to the environment by replacing unnecessary lawn in your yard with trees, shrubs and perennials.

Evaluate your lifestyle. Decide how much lawn you really need and where you need it. If you only use your yard for sunbathing, a few hundred square feet of lawn should be plenty. Consider having more than one lawn area - perhaps a small but beautifully manicured patch of lawn that acts as an extension of a patio with a separate area of rough lawn on which your kids can play.

As you plan your yard, try not to think of the lawn as the canvas upon which you place your planting beds. Instead, picture your lawn as a central opening surrounded by planting beds. Give it a distinct shape -- an oval or kidney shape or perhaps a gracious serpentine that flows through your yard. Then surround the lawn with planting beds that enclose and define it. That way, your lawn becomes a designed space -- a "place to be".



Get to know each area of lawn you plan to replace. Is it shady there or sunny? Moist or dry? Is the soil sandy or heavy clay? Once you know the site conditions, choose plants that are adapted to grow there. Use plants native to the Delaware Valley whenever possible. Native plants (plants growing here prior to the arrival of the European colonists) are just as threatened as wildlife

by development. And because native plants co-evolved with our wildlife they are often better sources of food and shelter than introduced plants. By including native plants in your yard you help to ensure both their survival and the survival of the birds, animals and insects that depend upon them.

If you would like to reduce your lawn area but still keep a traditional look to your yard, replace lawn with flowerbeds, shrub borders and sweeps of groundcover. If you are comfortable with a more relaxed, natural look, one of the most rewarding things you can do is to recreate natural communities of plants. In the shade of a large tree, plant a woodland community of understory trees, ferns and wildflowers. Plant meadow perennials and grasses in a dry, sunny area. Plant a wetland community in a wet, marshy area.

When you replace areas of lawn with the communities of native plants that would naturally occur there, you really are restoring the environment. In an amazingly short period of time, birds and animals will thank you by moving into the new habitat you have created.

### **For further reading on native plants**

There are many books available to help you learn more about using native plants. *The Wild Lawn Handbook* by Stevie Daniels is specifically about lawn alternatives. Ann Lovejoy has written a nice book about gardening and backyard design entitled *Further Down the Garden Path*. The Brooklyn Botanic Garden has published several excellent booklets about native plants and naturalistic landscaping, including: *The Environmental Gardener*, *Going Native*, and *Gardening with Wildflowers & Native Plants*. Other books that I have found useful include *Landscaping with Wildflowers* by Jim Wilson, *Growing and Propagating Showy Native Woody Plants* by Richard E. Bir, *Growing and Propagating Wild Flowers* by Harry R. Phillips and *The Native Plant Primer* by Carole Ottesen, *The Plants of Pennsylvania* by Ann Fowler Rhoads & Timothy A. Block.

*This fact sheet was written by Delaware Riverkeeper Network member and volunteer Brita van Rossum. Brita is an avid gardener who has used the techniques described above in her own back yard. Her interest in native plants stems from a life-long appreciation of the beauty of native wild flowers. She says that using native plants just makes sense, "We should use plants that developed here and are adapted to local climate and conditions rather than tulips from Turkey". Brita is currently studying toward a degree in Landscape Architecture at Temple University's Ambler Campus. Temple's program in Landscape Architecture places special emphasis on the use of native plants.*

#### **Delaware Riverkeeper Network**

*Working since 1988 to protect and restore the Delaware River, its tributaries and habitats.*

**P.O. Box 326, Washington Crossing, PA 18977**

**215-369-1188**

**delawareriverkeeper.org**





Cahill Associates  
Environmental Consultants  
104 South High Street  
West Chester, PA 19382  
Phone 610-696-4150  
Fax 610-696-8608

## Fact Sheet – Stormwater Runoff, the Lost Resource Land Cover and Hydrologic Implications

As land is developed throughout a watershed, no matter the size, the effect is felt everywhere downstream. The surface terrain is changed from meadow and woodlands to manicured lawns and impervious surfaces (buildings and pavement), dramatically altering the hydrologic cycle. Prior to development, the majority of rainfall would evaporate or transpire (taken up and utilized by plant material), and infiltrate to recharge groundwater, with minimal runoff (Figure 1). As the surface of the land in the watershed becomes more impervious, evaporation and transpiration is

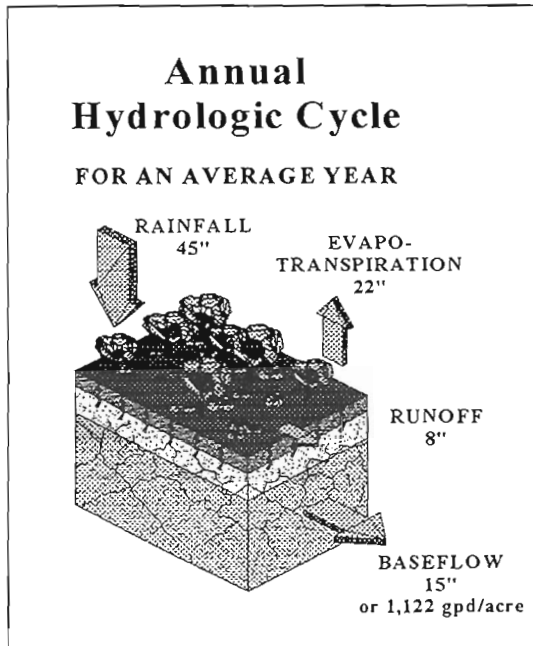

greatly reduced and runoff is maximized with greatly diminished infiltration opportunities (Figure 2).

Figure 1 (above) is the annual hydrologic cycle or water budget for the local region.

Figure 2 (right) quantifies the changes in the water budget of a parcel after development.

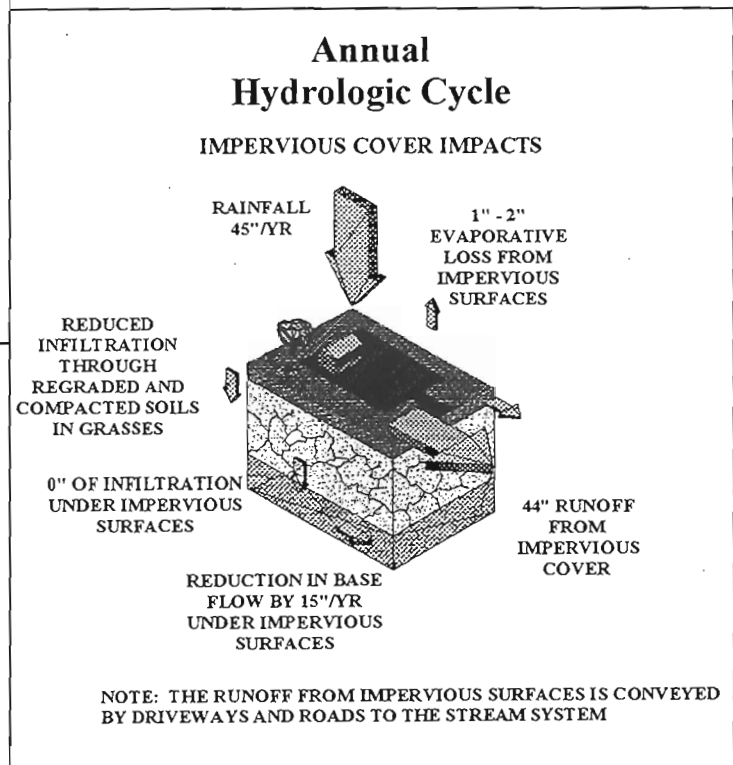

How land cover affects stormwater runoff has been long studied by the Natural Resources Conservation Service (formally the Soil Conservation Service). The attached tables are excerpts from the TR-55 Manual, a modeling program designed by the SCS to calculate the expected runoff from pre and post development conditions based on hydrologic soil types and land cover. The hydrologic soil classification, A through D, relates the native soils infiltration and percolation capacity with the potential to absorb rainfall. Soils with better percolation and infiltration, usually sands and gravels, are classified A. Clays and “Urban” soils with minimal infiltration and percolation potential are given a classification of D. The definition of each classification as provided by SCS scientists is provided below. Please note “D” soils are not defined as impervious, a common misconception.

- A. (Low runoff potential). Soils having a high infiltration rate even when thoroughly wetted and consisting chiefly of deep, well to excessively drained sands or gravels.
- B. Soils having a moderated infiltration rate when thoroughly wetted and consisting chiefly of moderately deep to deep, moderately well to well drained soils with moderately fine to moderately coarse texture.
- C. Soils having a slow infiltration rate when thoroughly wetted and consisting chiefly of soils with a layer that impedes downward movement of water or soils with moderately fine to fine texture.
- D. (High runoff potential). Soil having a very slow infiltration rate when thoroughly wetted and consisting chiefly of clay soils with a high swelling potential, soils with a permanent high water table, soils with a claypan or clay layer at or near the surface, and shallow soils over nearly impervious material.

The quality and quantity of vegetation on the surface also affects the amount of runoff from the land. Vegetation intercepts the runoff process by collecting stormwater on the leaves and evaporating it back to the atmosphere, disconnecting a portion of the rainfall from the land. Plants also use a large portion of the rainfall for transpiration, the process of uptake and utilizing the water to sustain life. Vegetation with longer root systems usually require more water for transpiration but allow for deeper pathways into the soil, providing additional capacity.

The SCS developed a model, the soil-cover-complex method, to evaluate the runoff potential of a site utilizing the hydrologic soil types, the land cover and rainfall. The hydrologic soil groups and vegetated cover have been evaluated to establish a Curve Number (CN). The Curve Number is a factor used in the SCS equation to estimate runoff for pre and post construction conditions. The greater the CN, the greater the potential for runoff. Impervious cover has the highest potential of runoff, and therefore has the highest CN of 98. See Attached Tables.

Although the soil-cover-complex method is the standard tool for the estimation of runoff, the model can be very subjective. For example, opinions on the vegetation condition can vary amongst professionals and dramatically affect the runoff calculations. More importantly, the



condition of the soil after construction is also open to evaluation based on compaction impacts and soil structural changes. Traditional practices of construction, where the site is cleared of native plant species and the earth is terra-formed, can change the hydrologic characteristics of the soil and greatly diminish infiltration/percolation capacity. Often soils within an urban area will be classified as “Urban” soil, indicating the soil mantle has been modified so severely it no longer exhibits the characteristics of the local soil groups.

Another subjective evaluation by professionals is how the curve numbers for soil types are applied to a site. The range of CNs acceptable for each vegetation condition per hydrologic soil type can vary the runoff significantly, allowing some professionals to “back into” a desired curve number for a site based on the available stormwater management (or storage) at the site.

Lastly, manicured lawns are drastically different from a native meadow. Lawns provide minimal evapo-transpiration benefits allowing significant runoff, which usually contains fertilizers and pesticides. These areas are generally compacted and therefore should be treated as “semi-pervious”. However, this is not uniform practice amongst professionals when stormwater calculations are developed for a site.

### **Delaware Riverkeeper Network**

*Working since 1988 to protect and restore the Delaware River, its tributaries and habitats.*

**P.O. Box 326, Washington Crossing, PA 18977**

**215-369-1188**

**delawareriverkeeper.org**

*Delaware Riverkeeper Network*



**1-800-8-DELAWARE**



Table 2-2a. - Runoff curve numbers for urban areas<sup>1</sup>

Cover description		Curve numbers for hydrologic soil group-			
Cover type and hydrologic condition	Average percent impervious area <sup>2</sup>	A	B	C	D
<i>Fully developed urban areas (vegetation established)</i>					
Open space (lawns, parks, golf courses, cemeteries, etc) <sup>3</sup> :					
Poor condition (grass cover < 50%).....		68	79	86	89
Fair condition (grass cover 50% to 75%).....		49	69	79	84
Good condition (grass cover >75%).....		39	61	74	80
Impervious areas:					
Paved parking lots, roofs, driveways, etc. (excluding right-of-way).....		98	98	98	98
Streets and roads:					
Paved: curb and storm sewers (excluding right-of-way).....		98	98	98	98
Paved: open ditches (including right-of-way).....		83	89	92	93
Gravel (including right-of-way).....		76	85	89	91
Dirt (including right-of-way).....		72	82	87	89
Western desert urban areas:					
Natural desert landscaping (pervious areas only) <sup>4</sup> .....		63	77	85	88
Artificial desert landscaping (impervious weed barrier, desert shrub with 1-2 inch sand or gravel mulch and basin borders).....		96	96	96	96
Urban districts:					
Commercial and business.....	85	89	92	94	95
Industrial.....	72	81	88	91	93
Residential districts by average lot size:					
1/8 acre or less (town houses).....	65	77	85	90	92
1/4 acre.....	38	61	75	83	87
1/3 acre.....	30	57	72	81	86
1/2 acre.....	25	54	70	80	85
1 acre.....	20	51	68	79	84
2 acres.....	12	46	65	77	82
<i>Developing urban area</i>					
Newly graded areas (pervious areas only, no vegetation) <sup>5</sup> .....		77	86	91	84
Idle lands (CN's are determined using cover types similar to those in table 2-2c).					

<sup>1</sup>Average runoff condition, and  $I_a = 0.2S$

<sup>2</sup>The average percent impervious area shown was used to develop the composite CN's. Other assumptions are as follows: impervious areas are directly connected to the drainage system, impervious areas have a CN of 98, and pervious areas are considered equivalent to open space in good hydrologic condition. CN's for other combinations of conditions may be computed using figure 2-3 or 2-4.

<sup>3</sup>CN's shown are equivalent to those of pasture. Composite CN's may be computed for other combinations of open space cover type.

<sup>4</sup>Composite CN's for natural desert landscaping should be computed using figures 2-3 or 2-4 based on the impervious area percentage (CN = 98) and the pervious area CN. The pervious area CN's are assumed equivalent to desert shrub in poor hydrologic condition.

<sup>5</sup>Composite CN's to use for the design of temporary measures during grading and construction should be computed using figure 2-3 or 2-4, based on the degree of development (impervious area percentage) and the CN's for the newly graded pervious areas.

Table 2-2c. - Runoff curve numbers for other agricultural lands<sup>1</sup>

Cover description		Curve numbers for soil group-			hydrologic
Cover type	Hydrologic Condition	A	B	C	D
Pasture, grassland, or range - continuous forage for grazing. <sup>2</sup>	Poor	68	79	86	89
	Fair	49	69	79	84
	Good	39	61	74	80
Meadow - continuous grass, protected from grazing and generally mowed for hay.	-	30	58	71	78
Brush - brush-weed-grass mixture with brush the major element. <sup>3</sup>	Poor	48	67	77	83
	Good	35	56	70	77
	Fair	30	48	65	73
Woods - grass combination (orchard or tree farm). <sup>5</sup>	Poor	57	73	82	86
	Good	43	65	76	82
	Fair	32	58	72	79
Woods. <sup>6</sup>	Poor	45	66	77	83
	Good	36	60	73	79
	Fair	30 <sup>(*)</sup>	55	70	77
Farmsteads - buildings, lanes, driveways, and surrounding lots.	-	59	74	82	86

<sup>1</sup>Average runoff condition, and  $I_a = 0.2S$

<sup>2</sup>Poor: <50% ground cover or heavily grazed with no mulch  
 Fair: 50 to 75% ground cover and not heavily grazed.  
 Good: >75% ground cover and lightly or only occasionally grazed.

<sup>3</sup>Poor: <50% ground cover.  
 Fair: 50 to 75% ground cover.  
 Good: >75% ground cover.

<sup>4</sup>Actual curve number is less than 30; use CN = 30 for runoff computations

<sup>5</sup>CN's shown were computed for areas with 50% woods and 50% grass (pasture) cover. Other combinations of conditions may be computed from the CN's for woods and pasture.

<sup>6</sup>Poor: Forest litter, small trees, and brush are destroyed by heavy grazing or regular burning.  
 Fair: Woods are grazed but not burned, and some forest litter covers the soil.  
 Good: Woods are protected from grazing, and litter and brush adequately cover the soil.

